

**Cazzuole - Frattoni - Attrezzi per Muratori
Trowels - Plastering Trowels - Masonry Tools**



50 ANNI 1957-2007

L'IMPRESA

Battiferro di Maniago S.n.c. è una ditta italiana che produce utensili per l'edilizia e opera da decenni sul mercato internazionale. Fu fondata sotto l'attuale denominazione nel 1957, ma il fondatore, Toni d'Avian Beltrame, lavorava nella industria manifatturiera per l'edilizia dall'inizio degli anni Venti. Allora le macchine utensili che sono oggi di uso corrente non erano ancora diffuse e ci si affidava perciò esclusivamente al lavoro manuale. Negli anni Sessanta la Battiferro incominciò la sua espansione in campo internazionale quando Emilio Beltrame assunse la dirigenza dell'azienda. Nel corso degli anni la Battiferro si è sempre mantenuta al passo con le mutevoli e sempre aggiornate tecniche manifatturiere usando macchine utensili sempre più efficienti ed autonome. Nel 1990 il figlio Antonio Beltrame si unì all'attività familiare imparando tutti i segreti nel campo della produzione delle cazzuole. Ora la terza generazione dei Beltrame sta assumendo la direzione dell'attività con la stesso impegno per continuare ad offrire ai nostri clienti il miglior prodotto possibile.

I PRODOTTI

Fra i prodotti della Battiferro ci sono cazzuole e frattazzi in numerosi modelli, utensili per scultori e per stuccature, frattazzi in gomma, spugna e spatole di vario genere. A partire dal processo produttivo delle origini, la ditta si è evoluta sia per far fronte al crescente volume d'affari, sia per sfruttare le più recenti innovazioni tecniche offerte dalle macchine a controllo computerizzato. Questo non significa che la Battiferro abbia rinunciato a controllare scrupolosamente la riuscita finale di ognuno dei suoi prodotti.

LE CARATTERISTICHE

L'alta qualità della gamma utensili della Battiferro è la ragione principale del suo successo. Le vendite delle cazzuole forgiate, che costituiscono il prodotto più diffuso della Battiferro, non sono mai diminuite nonostante il mercato sia sempre più attento ai prezzi. Questo perché la qualità costa, ma la qualità paga: i prodotti che si trovano vicini all'estremo inferiore dell'intervallo prezzi non hanno neanche la metà della durata delle cazzuole forgiate. Per quanto concerne invece la gamma delle saldate, esse possiedono sia il solido aspetto delle forgiate, sia il vantaggio di un prezzo inferiore.

IL MERCATO

Fin dalle sue origini, la Battiferro ha sempre venduto la maggior parte dei suoi prodotti sul mercato internazionale, dall'Australia al Medio Oriente, dall'Europa agli Stati Uniti. Per questa ragione essa ha una notevole esperienza sui modelli propri di molti mercati nazionali.

THE COMPANY

Battiferro di Maniago S.n.c. is an Italian manufacturer of construction tools that has been operating on the international market for decades. It was established with its current name in 1957, although the founder, Toni d'Avian Beltrame, had been working in the construction tools business from the early twenties. At that time the now widely spread manufacturing machines were not yet in use, and one had to rely solely on hand work. In 1960 Battiferro started his commercial expansion in the international market when Emilio Beltrame began manage the firm. During the years Battiferro has always kept up the pace with the changing and always up to date manufacturing techniques using always more efficient automatic machinery. In 1990, son Antonio Beltrame joined the family business to learn all secrets of the trowels' manufacturing process. Now the third generation of Beltrame is taking command of the business with the same dedication to serve our customers with the best products possible.

PRODUCTS

The company's product include brick trowels and plastering trowels in several patterns, floats and ornamental tools, putty knives and scrapers. The company's range has been evolving in order to cope with different customer demands and wider market areas. The recently automated production of welded brick trowels has been created with the aim of countering (although on a higher quality level) the commercial onset of the Far East. This does not mean that Battiferro has renounced paying attention to the final outcome of each of its products.

CHARACTERISTICS

The very high quality of Battiferro's range of tools is the main reason of its success. The sales of solid forged trowels, that are Battiferro's most widespread product, never decreased in spite of a market that is increasingly keen on prices. This is because quality costs, but it also lasts: products at the lower end of the price range do not have even half the durability and pliability of solid forged trowels. As for the welded brick trowels, they combine the compact outlook of forged brick trowels with the benefit of a lower price.

MARKET

Ever since it came into existence, the company has been selling most of this products on the international market, from Australia to the Middle East and from Europe to the United States. For this reason, it has a wide experience on the specific tool models that are sold on many national markets.

Art. 0.1	Cazzuole linea "Professional" <i>"Professional" line trowels</i> <i>Truelles ligne "Professionel"</i>	Pag. 2-5
Art. 0.2	Cazzuole linea "Standard" <i>"Standard" line trowels</i> New <i>Truelles ligne "Standard"</i>	Pag. 6-7
Art. 0.3	Cazzuole INOX <i>Stainless steel trowels</i> <i>Truelle INOX</i>	Pag. 8-9
Art. 0.4	Cazzuole forgiate con lama e gambo fatte da un unico pezzo di metallo <i>Forged trowels with blade and tang made from one piece of high grade steel</i> <i>Truelles forgées d'une seule piece en acier haute qualité</i>	Pag. 10-13
Art. 0.5	Frattoni <i>Plastering trowels</i> <i>Platoirs</i>	Pag. 14-21
Art. 0.6	Spatole <i>Putty knives</i> <i>Couteaux à peintre</i>	Pag. 22-23
Art. 0.7	Miscelatori <i>Mixers</i> <i>Melangeurs</i>	Pag. 24
Art. 0.A	Archeologia: Cazzuolini e ferri forgiati <i>Archaeology: Pointing trowels and forged tools</i> New <i>Archeology: Truelles et outils forgé</i>	Pag. 25
Art. 0.8	Ferri per modellatori <i>Carving tools</i> <i>Outils modelage</i>	Pag. 26-27
Art. 0.9	Spatoline per pittori <i>Palette knives</i> <i>Couteaux à peintre</i>	Pag. 28-31
Art. 10	Pale e picconi - Martelleria <i>Shelves and picks - Hammers</i> <i>Pelles et pioches - Martellerie</i>	Pag. 32-33

CAZZUOLE PROFESSIONAL

Trowel - Truelle

Art. 206.1	Manico legno Wood handle Manche bois	Cod.	Misura Size cm	
Cazzuola modello Tedesco		206.1-14	14	12
German pattern trowel		206.1-16	16	12
Truelle modèle Allemand		206.1-18	18	12
		206.1-20	20	12
		206.1-22	22	12

Art. 206.1/BM  Manico, Handle, Manche / Bi-material



Art. 206.1

Art. 207.1	Manico legno Wood handle Manche bois	Cod.	Misura Size cm	
Cazzuola modello Tedesco gambo a S		207.1-14	14	12
German pattern trowel swan neck		207.1-16	16	12
Truelle modèle Allemand		207.1-18	18	12
à col de cygne		207.1-20	20	12
		207.1-22	22	12

Art. 207.1/BM  Manico, Handle, Manche / Bi-material



Art. 207.1

Art. 274.1	Manico legno Wood handle Manche bois	Cod.	Misura Size cm	
Cazzuola punta tonda stretta modello Italiano		274.1-18	18	12
Italian pattern, narrow round-pointed trowel		274.1-19	19	12
Truelle Italienne ronde étroit		274.1-20	20	12
		274.1-21	21	12
		274.1-22	22	12
		274.1-23	23	12
		274.1-24	24	12

Art. 274.1/BM  Manico, Handle, Manche / Bi-material



Art. 274.1

Art. 275.1	Manico legno Wood handle Manche bois	Cod.	Misura Size cm	
Cazzuola punta tonda larga modello Italiano		275.1-18	18	12
Italian pattern, wide round-pointed trowel		275.1-19	19	12
Truelle Italienne ronde large		275.1-20	20	12
		275.1-21	21	12
		275.1-22	22	12

Art. 275.1/BM  Manico, Handle, Manche / Bi-material



Art. 275.1

Art. 276.1	Manico legno Wood handle Manche bois	Cod.	Misura Size cm	
Cazzuola punta quadra modello Italiano		276.1-16	16	12
Italian pattern square-pointed trowel		276.1-18	18	12
Truelle Italienne carrée		276.1-19	19	12
		276.1-20	20	12
		276.1-21	21	12
		276.1-22	22	12



Art. 276.1/BM  Manico, Handle, Manche / Bi-material



Art. 276.1



CAZZUOLE PROFESSIONAL

Trowel - Truelle

Art. 277.4	Manico legno Wood handle Manche bois	Cod.	Misura Size cm	
Cazzuola forgiata per mattoni modello Parigi		277.4-18 277.4-20	18 20	12 12
<i>Forged Paris pattern trowel</i> <i>Truelle forgé à brique façon Paris</i>				
Art. 277.4/BM		Manico, Handle, Manche / Bi-material		





Art. 277.4

Art. 278.4	Manico legno Wood handle Manche bois	Cod.	Misura Size cm	
Cazzuola forgiata per mattoni modello Charleroi		278.4	18	12
<i>Forged Charleroi pattern trowel</i> <i>Truelle forgé à brique façon Charleroi</i>				
Art. 278.4/BM		Manico, Handle, Manche / Bi-material		



Art. 278.4

Art. 279.1	Manico legno Wood handle Manche bois	Cod.	Misura Size Inch	Misura Size cm	
Cazzuola modello Walby		279.1-5	5"	14	12
<i>Walby pattern trowel</i>		279.1-6	6"	16	12
<i>Truelle modèle Walby</i>		279.1-7	7"	18	12
		279.1-8	8"	20	12
Art. 279.1/BM		Manico, Handle, Manche / Bi-material			



Art. 279.1

Art. 233.1	Manico legno Wood handle Manche bois	Cod.	Misura Size mm	
Cazzuolino per fughe mezzotondo		233.1-10	10	12
<i>Half-round caulking trowel</i> <i>Truelle à joint demi-rond</i>				



Art. 233.1

Art. 234.1	Manico, Handle, Manche / Bi-material	Cod.	Misura Size mm	
Cazzuolino per fughe piatto		234.1/BM-10	10	12
<i>Flat caulking trowel</i> <i>Truelle à joint plate</i>				

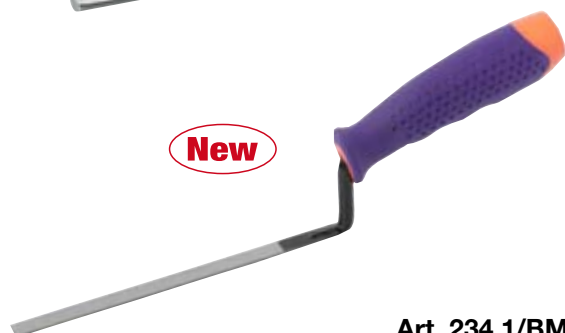

New

Art. 234.1/BM

CAZZUOLE PROFESSIONAL

Trowel - Truelle

Art. 198.1	Manico legno Wood handle Manche bois	Cod.	Misura Size cm	
Cazzuolino modello Belga		198.1-12	12	12
Belgian pattern trowel		198.1-14	14	12
Truelle modèle Belgique		198.1-16	16	12
Art. 198.1/BM 	Manico, Handle, Manche / Bi-material			





Art. 198.1

Art. 211.1	Manico legno Wood handle Manche bois	Cod.	Misura Size cm	
Cazzuolino punta quadra		211.1-12	12	12
Square pointed trowel		211.1-14	14	12
Truelle pointe carrée		211.1-16	16	12
Art. 211.1/BM 	Manico, Handle, Manche / Bi-material			



Art. 211.1

Art. 217.1	Manico legno Wood handle Manche bois	Cod.	Misura Size cm	
Cazzuolino lingua di gatto		217.1-12	12	12
Cat's tongue trowel		217.1-14	14	12
Truelle langue de chat		217.1-16	16	12
Art. 217.1/BM 	Manico, Handle, Manche / Bi-material			





Art. 217.1

Art. 218.1	Manico legno Wood handle Manche bois	Cod.	Misura Size cm	
Cazzuolino a "Foglia di Olivo"		218.1-12	12	12
Olive leaf trowel		218.1-14	14	12
Truelle à feuille d'olive		218.1-16	16	12
Art. 218.1/BM 	Manico, Handle, Manche / Bi-material			





Art. 218.1

Art. 221.1	Manico legno Wood handle Manche bois	Cod.	Misura Size cm	
Cazzuolino triangolare		221.1-12	12	12
Triangular trowel		221.1-13	13	12
Truelle triangulaire		221.1-14	14	12
		221.1-15	15	12
		221.1-16	16	12
Art. 221.1/BM 	Manico, Handle, Manche / Bi-material			



Art. 221.1

Art. 222.1	Manico legno Wood handle Manche bois	Cod.	Misura Size cm	
Cazzuolino punta tonda		222.1-12	12	12
Round-pointed trowel		222.1-13	13	12
Truelle pointe ronde		222.1-14	14	12
		222.1-15	15	12
		222.1-16	16	12
Art. 222.1/BM 	Manico, Handle, Manche / Bi-material			



Art. 222.1

CAZZUOLE PROFESSIONAL

Trowel - Truelle

Art. 237.1	Manico in legno verniciato <i>Painted wood handle</i> <i>Manche en bois vernie</i>	Cod.	Misura Size cm	
Cazzuolino modello Malta <i>Malta pattern trowel</i> <i>Truelle modèle Malte</i>		237.1	16	12



Art. 237.1

Art. 238.1	Manico legno <i>Wood handle</i> <i>Manche bois</i>	Cod.	Misura Size cm	
Cazzuola da giardinaggio larga <i>Wide gardening trowel</i> <i>Pelle large pour jardinage</i>		238.1	16	12



Art. 238.1

Art. 239.1	Manico legno <i>Wood handle</i> <i>Manche bois</i>	Cod.	Misura Size cm	
Cazzuola da giardinaggio stretta <i>Narrow gardening trowel</i> <i>Pelle étroit pour jardinage</i>		239.1	16	12



Art. 239.1

Art. 240.1	Manico legno <i>Wood handle</i> <i>Manche bois</i>	Cod.	Misura Size cm	
Rastrello da giardinaggio <i>Gardening rake</i> <i>Râteau pour jardinage</i>		240.1	14	12



Art. 240.1

Art. 241.1 (set 3 pezzi - 3 pieces)		Cod.	
Set giardinaggio composto da: due Cazzuole - Rastrello <i>Gardening set comprehensive of:</i> <i>two Trowels - Rake</i> <i>Set jardinage comprenant:</i> <i>deux Pelles - Râteau</i>		241.1	60



Art. 241.1

CAZZUOLE STANDARD

Trowel - Truelle

Art. 206.2/BM <i>Manico, Handle, Manche / Bi-material</i>	Cod.	Misura Size cm	
Cazzuola modello Tedesco	206.2/BM-14	14	12
<i>German pattern trowel</i>	206.2/BM-16	16	12
<i>Truelle modèle Allemand</i>	206.2/BM-18	18	12
	206.2/BM-20	20	12
	206.2/BM-22	22	12

Art. 206.2  Manico legno - Wood handle - Manche bois



Art. 207.2/BM <i>Manico, Handle, Manche / Bi-material</i>	Cod.	Misura Size cm	
Cazzuola modello Tedesco gambo a S	207.2/BM-14	14	12
<i>Swan neck German pattern trowel</i>	207.2/BM-16	16	12
<i>Truelle modèle Allemand à col de cygne</i>	207.2/BM-18	18	12
	207.2/BM-20	20	12
	207.2/BM-22	22	12

Art. 207.2  Manico legno - Wood handle - Manche bois



Art. 274.2/BM <i>Manico, Handle, Manche / Bi-material</i>	Cod.	Misura Size cm	
Cazzuola punta tonda stretta modello Italiano	274.2/BM-18	18	12
<i>Italian pattern, narrow round-pointed trowel</i>	274.2/BM-19	19	12
	274.2/BM-20	20	12
	274.2/BM-21	21	12
<i>Truelle Italienne ronde étroit</i>	274.2/BM-22	22	12
	274.2/BM-24	24	12

Art. 274.2  Manico legno - Wood handle - Manche bois



Art. 275.2/BM <i>Manico, Handle, Manche / Bi-material</i>	Cod.	Misura Size cm	
Cazzuola punta tonda larga modello Italiano	275.2/BM-18	18	12
<i>Italian pattern, wide round-pointed trowel</i>	275.2/BM-19	19	12
	275.2/BM-20	20	12
	275.2/BM-21	21	12
<i>Truelle Italienne ronde large</i>	275.2/BM-22	22	12

Art. 275.2  Manico legno - Wood handle - Manche bois



Art. 276.2/BM <i>Manico, Handle, Manche / Bi-material</i>	Cod.	Misura Size cm	
Cazzuola punta quadra modello Italiano	276.2/BM-18	18	12
<i>Italian pattern square-pointed trowel</i>	276.2/BM-19	19	12
	276.2/BM-20	20	12
	276.2/BM-21	21	12
<i>Truelle Italienne carrée</i>	276.2/BM-22	22	12

Art. 276.2  Manico legno - Wood handle - Manche bois



CAZZUOLE STANDARD

Trowel - Truelle

Art. 279.2/BM <i>Manico, Handle, Manche / Bi-material</i>	Cod.	Misura Size Inch	Misura Size cm	
Cazzuola modello Walby	279.2/BM-5	5"	14	12
<i>Walby pattern trowel</i>	279.2/BM-6	6"	16	12
<i>Truelle modèle Walby</i>	279.2/BM-7	7"	18	12
	279.2/BM-8	8"	20	12

Art. 279.2  Manico legno - Wood handle - Manche bois



Art. 211.2/BM <i>Manico, Handle, Manche / Bi-material</i>	Cod.	Misura Size cm	
Cazzuolino punta quadra	211.2/BM-12	12	12
<i>Square pointed trowel</i>	211.2/BM-14	14	12
<i>Truelle pointe carrée</i>	211.2/BM-16	16	12

Art. 211.2  Manico legno - Wood handle - Manche bois



Art. 217.2/BM <i>Manico, Handle, Manche / Bi-material</i>	Cod.	Misura Size cm	
Cazzuolino lingua di gatto	217.2/BM-12	12	12
<i>Cat's tongue trowel</i>	217.2/BM-14	14	12
<i>Truelle langue de chat</i>	217.2/BM-16	16	12

Art. 217.2  Manico legno - Wood handle - Manche bois



Art. 221.2/BM <i>Manico, Handle, Manche / Bi-material</i>	Cod.	Misura Size cm	
Cazzuolino triangolare	221.2/BM-12	12	12
<i>Triangular trowel</i>	221.2/BM-14	14	12
<i>Truelle triangulaire</i>	221.2/BM-16	16	12

Art. 221.2  Manico legno - Wood handle - Manche bois



Art. 222.2/BM <i>Manico, Handle, Manche / Bi-material</i>	Cod.	Misura Size cm	
Cazzuolino punta tonda	222.2/BM-12	12	12
<i>Round-pointed trowel</i>	222.2/BM-14	14	12
<i>Truelle pointe ronde</i>	222.2/BM-16	16	12

Art. 222.2  Manico legno - Wood handle - Manche bois



CAZZUOLE INOX

Stainless steel trowel - Truelle inox

Art. 206.3	Manico in legno verniciato <i>Painted wood handle</i> <i>Manche en bois verni</i>	Cod.	Misura Size cm	Misura Size Inch	
Cazzuola modello Tedesco inox		206.3-16	16	6-3/8"	12
<i>Stainless steel German pattern trowel</i>		206.3-18	18	7"	12
<i>Truelle modèle Allemand inox</i>		206.3-20	20	8"	12

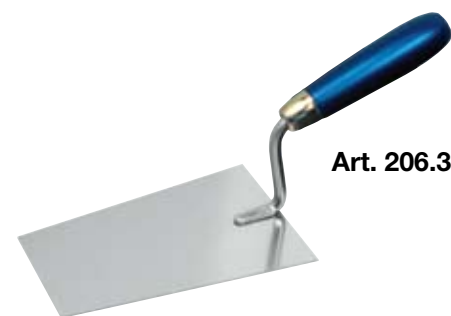

Art. 206.3

Art. 207.3	Manico in legno verniciato <i>Painted wood handle</i> <i>Manche en bois verni</i>	Cod.	Misura Size cm	Misura Size Inch	
Cazzuola modello Tedesco inox con gambo a S		207.3-16	16	6-3/8"	12
<i>Stainless steel German pattern trowel with swan neck</i>		207.3-18	18	7"	12
<i>Truelle modèle Allemand à col de cigne inox</i>		207.3-20	20	8"	12



Art. 207.3

Art. 274.3	Manico in legno verniciato <i>Painted wood handle</i> <i>Manche en bois verni</i>	Cod.	Misura Size cm	Misura Size Inch	
Cazzuola punta tonda stretta modello Italiano inox		274.3-18	18	7"	12
<i>Stainless steel Italian pattern narrow round - pointed trowel</i>		274.3-20	20	8"	12
<i>Truelle Italienne ronde étroit inox</i>		274.3-22	22	8-5/8"	12

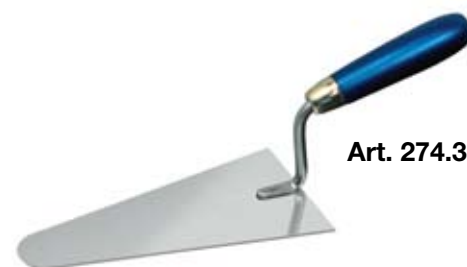

Art. 274.3

Art. 275.3	Manico in legno verniciato <i>Painted wood handle</i> <i>Manche en bois verni</i>	Cod.	Misura Size cm	Misura Size Inch	
Cazzuola punta tonda larga modello Italiano inox		275.3-18	18	7"	12
<i>Stainless steel Italian pattern wide round - pointed trowel</i>		275.3-20	20	8"	12
<i>Truelle Italienne ronde large inox</i>		275.3-22	22	8-5/8"	12



Art. 275.3

Art. 276.3	Manico in legno verniciato <i>Painted wood handle</i> <i>Manche en bois verni</i>	Cod.	Misura Size cm	Misura Size Inch	
Cazzuola punta quadra modello Italiano inox		276.3-18	18	7"	12
<i>Stainless steel Italian pattern square-pointed trowel</i>		276.3-20	20	8"	12
<i>Truelle Italienne carrée inox</i>		276.3-22	22	8-5/8"	12

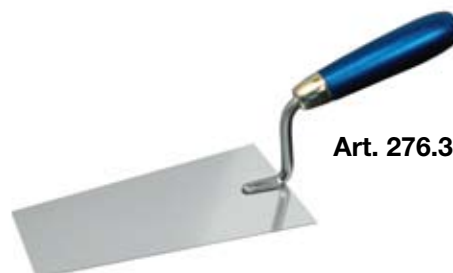

Art. 276.3

Art. 288.3	Manico in legno verniciato <i>Painted wood handle</i> <i>Manche en bois verni</i>	Cod.	Misura Size cm	Misura Size Inch	
Cazzuolino Margin inox		288.3-5x1.5	5"x1.5"	5"x1-1/2"	12
<i>Stainless steel Margin trowel</i>		288.3-5x2	5"x2"	5"x2"	12
<i>Truelle Margin inox</i>		288.3-6x2	6"x2"	6"x2"	12
		288.3-8x2	8"x2"	8"x2"	12



Art. 288.3

CAZZUOLE INOX

Stainless steel trowel - Truelle inox

Art. 211.3	Manico in legno verniciato Painted wood handle Manche en bois verni	Cod.	Misura Size cm	Misura Size Inch	
Cazzuolino punta quadra inox		211.3-14	14	5-1/2"	12
<i>Stainless steel square pointed trowel</i>		211.3-16	16	6-3/8"	12
<i>Truelle pointe carrée inox</i>					



Art. 211.3

Art. 217.3	Manico in legno verniciato Painted wood handle Manche en bois verni	Cod.	Misura Size cm	Misura Size Inch	
Cazzuolino lingua di gatto inox		217.3-14	14	5-1/2"	12
<i>Stainless steel cat's tongue trowel</i>		217.3-16	16	6-3/8"	12
<i>Truelle langue de chat inox</i>					



Art. 217.3

Art. 221.3	Manico in legno verniciato Painted wood handle Manche en bois verni	Cod.	Misura Size cm	Misura Size Inch	
Cazzuolino triangolare inox		221.3-14	14	5-1/2"	12
<i>Stainless steel triangular trowel</i>		221.3-16	16	6-3/8"	12
<i>Truelle triangulaire inox</i>					



Art. 221.3

Art. 222.3	Manico in legno verniciato Painted wood handle Manche en bois verni	Cod.	Misura Size cm	Misura Size Inch	
Cazzuolino punta tonda inox		222.3-14	14	5-1/2"	12
<i>Stainless steel round pointed trowel</i>		222.3-16	16	6-3/8"	12
<i>Truelle pointe ronde inox</i>					



Art. 222.3

Art. 225.3	Manico in legno verniciato Painted wood handle Manche en bois verni	Cod.	Misura Size cm	Misura Size Inch	
Cazzuolino per angoli esterni inox		225.3-8	8x6	3"x2-3/8 "	12
<i>Stainless steel external corner trowel</i>		225.3-11	11x7	4-3/8 "x2-3/4"	12
<i>Truelle d'angle extérieur inox</i>		225.3-12	12x10	4-3/4"x4"	12

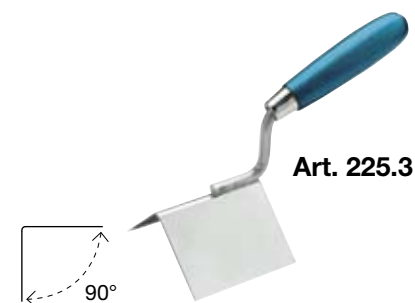

Art. 225.3

Art. 226.3	Manico in legno verniciato Painted wood handle Manche en bois verni	Cod.	Misura Size cm	Misura Size Inch	
Cazzuolino per angoli interni inox		226.3-8	8x6	3"x2-3/8 "	12
<i>Stainless steel internal corner trowel</i>		226.3-11	11x7	4-3/8 "x2-3/4"	12
<i>Truelle d'angle intérieur inox</i>		226.3-12	12x10	4-3/4"x4"	12







Art. 226.3



CAZZUOLE FORGIATE



Forged trowel - Truelle forgé



Blade and tang forged from one piece of high grade steel



Art. 291.4/SG Soft grip handle	Forgiate Forged Cod.	Saldate Welded Cod.	Misura Size Inch	
London pattern	291.4/SG-10	291.1/SG-10	10"	6
trowel assymmetric shape	291.4/SG-11	291.1/SG-11	11"	6
	291.4/SG-12	291.1/SG-12	12"	6
	291.4/SG-13	291.1/SG-13	13"	6
Art. 291.4  Wood handle				

Art. 295.4/SG Soft grip handle	Forgiate Forged Cod.	Saldate Welded Cod.	Misura Size Inch	
USA narrow	295.4/SG-10	295.1/SG-10	10"	6
London trowel	295.4/SG-10,5	295.1/SG-10,5	10-1/2"	6
	295.4/SG-11	295.1/SG-11	11"	6
	295.4/SG-11,5	295.1/SG-11,5	11-1/2"	6
	295.4/SG-12	295.1/SG-12	12"	6
	295.4/SG-12,5	295.1/SG-12,5	12-1/2"	6
	295.4/SG-13	295.1/SG-13	13	6
Art. 295.4  Wood handle				

Art. 296.4/SG Soft grip handle	Forgiate Forged Cod.	Saldate Welded Cod.	Misura Size Inch	
Philadelphia trowel	296.4/SG-10	296.1/SG-10	10"	6
	296.4/SG-11	296.1/SG-11	11"	6
	296.4/SG-12	296.1/SG-12	12"	6
Art. 296.4  Wood handle				

Art. 297.4/SG Soft grip handle	Forgiate Forged Cod.	Saldate Welded Cod.	Misura Size Inch	
Wide London trowel	297.4/SG-10	297.1/SG-10	10"	6
	297.4/SG-11	297.1/SG-11	11"	6
	297.4/SG-12	297.1/SG-12	12"	6
Art. 297.4  Wood handle				

Art. 100.4/SG Soft grip handle	Forgiate Forged Cod.	Saldate Welded Cod.	Misura Size Inch	
Bucket trowel	100.4/SG	100.1/SG	6	6
Art. 100.4  Wood handle				

Art. 151.4/SG Soft grip handle	Forgiate Forged Cod.	Saldate Welded Cod.	Misura Size Inch	
Buttering trowel	151.4/SG	151.1/SG	7"	6
Art. 151.4  Wood handle				



HANGER
Art. 050



Art. 291.4/SG



Art. 295.4/SG



Art. 296.4/SG



Art. 297.4/SG



Art. 100.4/SG







Art. 151.4/SG



CAZZUOLE FORGIATE



Forged trowel - Truelle forgé



Blade and tang forged from one piece of high grade steel



Art. 102.4 Wood handle	Forgiate Forged Cod.	Saldate Welded Cod.	Misura Size Inch	
Cross joint trowel	102.4	102.1	5"	12
Art. 102.4/SG  Soft hand grip				

Art. 152.4 Wood handle	Forgiate Forged Cod.	Saldate Welded Cod.	Misura Size Inch	
Duck bill trowel	152.4	152.1	10"	12
Art. 152.4/SG  Soft grip hand				

Art. 210.4 Wood handle	Forgiate Forged Cod.	Saldate Welded Cod.	Misura Size Inch	
Gauging trowel	210.4-6	210.1-6	6"	12
	210.4-7	210.1-7	7"	12
	210.4-8	210.1-8	8"	12
Art. 210.4/SG  Soft grip hand				

Art. 257.4 Wood handle	Forgiate Forged Cod.		Misura Size Inch		
Caulking trowel	257.4-3/16	257.4-5/8	3/16"	5/8"	12
Tuck pointer	257.4-1/4	257.4-3/4	1/4"	3/4"	12
	257.4-3/8	257.4-7/8	3/8"	7/8"	12
	257.4-1/2	257.4-1	1/2"	1"	12
Art. 257.4/SG  Soft grip hand					

Art. 288.4 Wood handle	Forgiate Forged Cod.	Saldate Welded Cod.	Misura Size Inch	
Margin trowel	288.4-5x1.5	288.1-5 x1.5	5"x1 1/2"	12
	288.4-5x2	288.1-5 x 2	5"x 2"	12
	288.4-6x2	288.1-6 x 2	6"x 2"	12
	288.4-8x2	288.1-8 x 2	8"x 2"	12
Art. 288.4/SG  Soft grip hand				

Art. 289.4 Wood handle	Forgiate Forged Cod.	Saldate Welded Cod.	Misura Size Inch	
Pointing trowel	289.4-4.5	289.1-4.5	4-1/2"	12
	289.4-5	289.1-5	5"	12
	289.4-5.5	289.1-5.5	5-1/2"	12
	289.4-6	289.1-6	6"	12
	289.4-7	289.1-7	7"	12
Art. 289.4/SG  Soft grip hand				



HANGER
Art. 050



Art. 102.4



Art. 152.4



Art. 210.4



Art. 257.4



Art. 288.4





Art. 289.4

CAZZUOLE FORGIATE

Forged trowel - Truelle forgé

Blade and tang forged from one piece of high grade steel



Art. 401.4	Manico legno Wood handle Manche bois	Forgiate Forged Cod.	Saldate Welded Cod.	Misura Size cm	
Cazzuola modello Catalano		401.4-15	401.1-15	15	6
Catalan pattern trowel		401.4-16,5	401.1-16,5	16,5	6
Truelle modèle Catalogne		401.4-18	401.1-18	18	6
Art. 401.4/BM  Manico, Handle, Manche / Bi-material					



HANGER
Art. 050





Art. 401.4

Art. 402.4	Manico legno Wood handle Manche bois	Forgiate Forged Cod.	Saldate Welded Cod.	Misura Size cm	
Cazzuola modello Siviglia		402.4-18	402.1-18	18	6
Seville pattern trowel		402.4-20	402.1-20	20	6
Truelle modèle Seville					
Art. 402.4/BM  Manico, Handle, Manche / Bi-material					





Art. 402.4

Art. 403.4	Manico legno Wood handle Manche bois	Forgiate Forged Cod.	Saldate Welded Cod.	Misura Size cm	
Cazzuola modello Madrid		403.4-11	403.1-11	11	6
Madrid pattern trowel		403.4-14	403.1-14	14	6
Truelle modèle Madrid		403.4-16	403.1-16	16	6
		403.4-19	403.1-19	19	12
		403.4-22	403.1-22	22	12
		403.4-23	403.1-23	23	12
		403.4-24	403.1-24	24	12
Art. 403.4/BM  Manico, Handle, Manche / Bi-material					





Art. 403.4

Art. 404.4	Manico legno Wood handle Manche bois	Forgiate Forged Cod.	Saldate Welded Cod.	Misura Size cm	
Cazzuola quadra stretta modello Norte		404.4-18	404.1-18	18	6
Narrow square trowel Norte pattern		404.4-19	404.1-19	19	6
Truelle carrée étroit modèle Norte					
Art. 404.4/BM  Manico, Handle, Manche / Bi-material					



Art. 404.4

Art. 405.4	Manico legno Wood handle Manche bois	Forgiate Forged Cod.	Saldate Welded Cod.	Misura Size cm	
Cazzuola quadra larga modello Norte		405.4-18	405.1-18	18	6
Wide square trowel Norte pattern					
Truelle carrée large modèle Norte					
Art. 405.4/BM  Manico, Handle, Manche / Bi-material					





Art. 405.4

CAZZUOLE FORGIATE

Forged trowel - Truelle forgé

Blade and tang forged from one piece of high grade steel



Art. 406.4	Manico legno Wood handle Manche bois	Forgiate Forged Cod.	Saldate Welded Cod.	Misura Size cm	
Cazzuolino modello Spagnolo Spanish pattern trowel Truelle modèle Espagnol		406.4	406.1	13,5	12
Art. 406.4/BM	 Manico, Handle, Manche / Bi-material				



HANGER
Art. 050





Art. 406.4

Art. 407.4	Manico legno Wood handle Manche bois	Forgiate Forged Cod.	Saldate Welded Cod.	Misura Size cm	
Cazzuolino triangolare modello Spagnolo Spanish triangular trowel Truelle triangulaire Espagnol		407.4	407.1	12	12
Art. 407.4/BM	 Manico, Handle, Manche / Bi-material				





Art. 407.4

Art. 408.4	Manico legno Wood handle Manche bois	Forgiate Forged Cod.	Saldate Welded Cod.	Misura Size cm	
Cazzuola punta acuta modello Greco Greek sharp pointed trowel Truelle pointe aigue modèle Grec		408.4	408.1	26	6
Art. 408.4/BM	 Manico, Handle, Manche / Bi-material				





Art. 408.4

Art. 409.4	Manico legno Wood handle Manche bois	Forgiate Forged Cod.	Saldate Welded Cod.	Misura Size cm	
Cazzuola punta tonda modello Greco Greek round pointed trowel Truelle pointe ronde modèle Grec	409.4-18	409.1-18	18	6	
	409.4-20	409.1-20	20	6	
	409.4-22	409.1-22	22	6	
	409.4-24	409.1-24	24	6	
	409.4-26	409.1-26	26	6	
	409.4-28	419.1-28	28	6	
Art. 409.4/BM	 Manico, Handle, Manche / Bi-material				



Art. 409.4

Art. 410.4	Manico legno Wood handle Manche bois	Forgiate Forged Cod.	Saldate Welded Cod.	Misura Size cm	
Cazzuola modello Creta Creta pattern trowel Truelle modèle Creta	410.4-18	410.1-18	18	6	
	410.4-20	410.1-20	20	6	
	410.4-22	410.1-22	22	6	
	410.4-24	410.1-24	24	6	
	410.4-26	410.1-26	26	6	
	410.4-28	410.1-28	28	6	
Art. 410.4/BM	 Manico, Handle, Manche / Bi-material				



Art. 410.4

Art. 258.5	Cod.	Misura Size cm	📦
Frattoni manico Bi-materiale lama acciaio	258.5-12	28x12	12
Steel blade Bi-material handle plastering trowel	258.5-8	20x8	12
	258.5-10	24x10	12
Platoir manche Bi-matière lame en acier	258.5-361	36x10	12
	258.5-362	36x12	12
Art. 258.5/FC	Cod.	cm	📦
Forcella corta per una maggiore flessibilità della lama	258.5/FC-12	28x12	6
Short mounting with more flexible blade	258.5/FC-20	20x8	6
Monture courte avec lame plus flexible	258.5/FC-24	24x10	6



Art. 258.5

Art. 258.5/IN	Cod.	cm	📦
Frattoni manico Bi-materiale lama acciaio inox	258.5/IN-12	28x12	12
Stainless Steel blade	258.5/IN-8	20x8	12
Bi-material handle plastering trowel	258.5/IN-10	24x10	12
Platoir manche Bi-matière lame inox	258.5/IN-361	36x10	12
	258.5/IN-362	36x12	12



Art. 258.5/IN

Art. 259.5	Lama - Blade - Lame cm 28x12 inch 11x4-1/2"	Cod.	mm 📏	📦
Frattoni manico Bi-materiale lama acciaio dentata		259.5-5	5x5	12
Notched steel blade		259.5-7	7x7	12
Bi-material handle plastering trowel		259.5-10	10x10	12
		259.5-12	12x12	12
Platoir manche Bi-matière lame en acier denté		259.5-V4	1/4"	12
		259.5-V	1/8"	12



Art. 259.5

Art. 260.5	Cod.	Misura Size cm	📦
Frattoni manico legno verniciato lama acciaio	260.5-12	28x12	12
Steel blade plastering trowel with varnished wood handle	260.5-8	20x8	12
Platoir manche bois verni lame en acier	260.5-10	24x10	12
Art. 260.5/FC	Cod.	Misura Size cm	📦
Forcella corta per una maggiore flessibilità della lama	260.5/FC-12	28x12	12
Short mounting with more flexible blade	260.5/FC-8	20x8	12
Monture courte avec lame plus flexible	260.5/FC-10	24x10	12



Art. 260.5

FRATTONI

Plastering trowel - Platoir

Art. 260.5/IN	Cod.	cm	📦
Frattoni manico legno verniciato lama acciaio inox	260.5/IN-12	28x12	12
<i>Stainless Steel blade plastering trowel with varnished wood handle</i>	260.5/IN-8	20x8	12
<i>Platoir manche bois verni lame inox</i>	260.5/IN-10	24x10	12



Art. 261.5	Lama - Blade - Lame cm 28x12 inch 11x4-1/2"	Cod.	mm 📏	📦
Frattoni manico legno verniciato lama acciaio dentata		261.5-5	5x5	12
<i>Notched steel blade plastering trowel with varnished wood handle</i>		261.5-7	7x7	12
<i>Platoir manche bois verni lame en acier denté</i>		261.5-10	10x10	12
		261.5-12	12x12	12



Art. 262.5	Cod.	Misura Size cm	📦
Frattoni con forcella in ABS blu lama acciaio	262.5-12	28x12	12
<i>Steel blade plastering trowel with blue ABS mounting</i>			
<i>Platoir monture plastique ABS bleu, lame en acier</i>			



Art. 263.5	Lama - Blade - Lame cm 28x12 28x13 inch 11x4-1/2" 11x5	Cod.	mm 📏	📦
Frattoni con forcella in ABS blu lama acciaio dentata		263.5-5	5x5	12
<i>Notched steel blade plastering trowel with blue ABS mounting</i>		263.5-7	7x7	12
<i>Platoir monture plastique ABS bleu, lame en acier denté</i>		263.5-10	10x10	12
		263.5-12	12x12	12
		263.5-V	1/8"	12

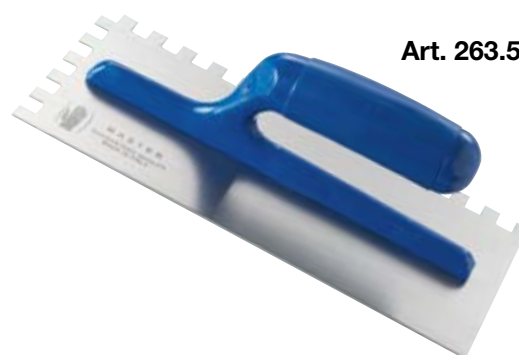

Art. 264.5/B Bianco-White-Blanche	Art. 264.5/R Rosso-Red-Rouge	Cod.	Misura Size cm	📦
Frattoni con forcella e lama in ABS <i>ABS mounting and blade plastering trowel</i>		264.5/B	28x13	12
<i>Platoir avec monture et lame en ABS</i>		264.5/R	28x13	12





FRATTONI

Plastering trowel - Platoir

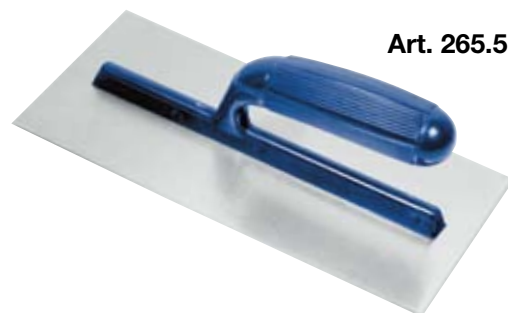
Art. 265.5	Cod.	Misura Size cm	
Frattoni con forcella in ABS blu lama acciaio	265.5-12	28x12	12
<i>Steel blade plastering trowel with blue ABS mounting</i>	265.5-13	28x13	12
<i>Platoir monture plastique ABS bleu, lame en acier</i>			



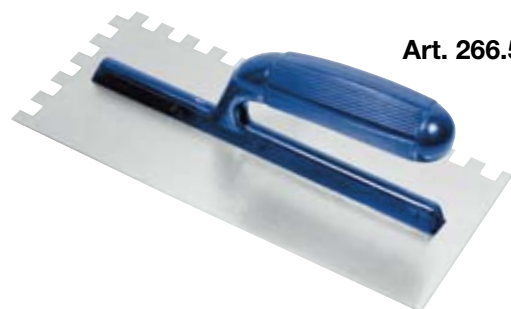

Art. 265.5

Art. 266.5	Lama - Blade - Lame cm 28x12 28x13 inch 11x4-1/2" 11x5"	Cod.	mm 	
Frattoni con forcella in ABS blu lama acciaio dentata		266.5-5	5x5	12
<i>Notched steel blade plastering trowel with blue ABS mounting</i>		266.5-7	7x7	12
<i>Platoir monture plastique ABS bleu, lame en acier denté</i>		266.5-10	10x10	12
		266.5-12	12x12	12



Art. 266.5

Art. 269.5	Cod.	Misura Size cm	
Frattoni manico legno, lama acciaio	269.5-12	28x12	12
<i>Steel blade plastering trowel with wood handle</i>	269.5-13	28x13	12
<i>Platoir manche bois lame en acier</i>			
Art. 269.5/IN	Cod.	cm	
Lama Inox - <i>Stainless steel blade - Lame Inox</i>	269.5/IN-12	28x12	12



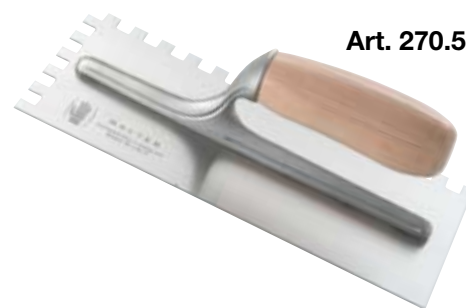

Art. 269.5

Art. 270.5	Lama - Blade - Lame cm 28x12 28x13 inch 11x4-1/2" 11x5"	Cod.	mm	
Frattoni manico legno, lama acciaio dentata		270.5-5	5x5	12
<i>Notched steel blade plastering trowel with wood handle</i>		270.5-7	7x7	12
<i>Platoir manche bois lame en acier denté</i>		270.5-10	10x10	12
		270.5-12	12x12	12
		270.5-V	1/8"	12



Art. 270.5

STUCCO VENEZIANO - VENETIAN STUCCO

Art. 301.5	Cod.	Misura Size cm	
Frattoni manico legno verniciato lama acciaio inox trapezoidale angoli arrotondati con trattamento elettrolitico	301.5-20	20x8	6
<i>Plastering trowel with round corners stainless steel trapezoidal blade with electrolytic treatment, varnished wood handle</i>	301.5-24	24x10	6
<i>Platoir lame inox trapézoidal avec traitement électrolytique angles arrondis manche bois verni</i>	301.5-28	28x12	6
Art. 301.5/LS	Cod.	cm	
Lama smussata lucida	301.5/LS-20	20x8	6
<i>Blade with mirror polished radius edges</i>	301.5/LS-24	24x10	6
<i>Lame avec borde bisautés très brillante</i>	301.5/LS-28	28x12	6



Art. 301.5

INOX
stainless steel

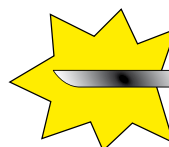



Art. 301.5/LS

FRATTONI

Plastering trowel - Platoir

STUCCO VENEZIANO - VENETIAN STUCCO

Art. 302.5	Cod.	Misura Size cm	
Frattoni manico Bi-materiale lama acciaio inox trapezoidale angoli arrotondati con trattamento elettrolitico <i>Plastering trowel with round corners stainless steel trapezoidal blade with electrolytic treatment, Bi-material handle</i> <i>Platoir lame inox trapézoidal avec traitement électrolytique angles arrondis manche Bi-matière</i>	302.5-20	20x8	6
	302.5-24	24x10	6
	302.5-28	28x12	6
Art. 302.5/LS	Cod.	cm	
Lama smussata lucida <i>Blade with mirror polished radius edges</i> <i>Lame avec borde bisautés très brillante</i>	302.5/LS-20	20x8	6
	302.5/LS-24	24x10	6
	302.5/LS-28	28x12	6



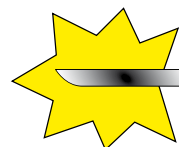

Art. 302.5

INOX
stainless steel



Art. 302.5/LS

Art. 303.5	Cod.	Misura Size cm	
Frattoni manico legno verniciato lama acciaio inox con trattamento elettrolitico angoli arrotondati <i>Plastering trowel with round corners stainless steel blade with electrolytic treatment, varnished wood handle</i> <i>Platoir lame inox avec traitement électrolytique angles arrondis manche bois verni</i>	303.5-20	20x8	6
	303.5-24	24x10	6
	303.5-28	28x12	6
Art. 303.5/LS	Cod.	cm	
Lama smussata lucida <i>Blade with mirror polished radius edges</i> <i>Lame avec borde bisautés très brillante</i>	303.5/LS-20	20x8	6
	303.5/LS-24	24x10	6
	303.5/LS-28	28x12	6



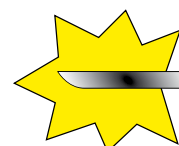

Art. 303.5

INOX
stainless steel



Art. 303.5/LS

Art. 304.5	Cod.	Misura Size cm	
Frattoni manico Bi-materiale lama acciaio inox con trattamento elettrolitico, angoli arrotondati <i>Plastering trowel with round corners stainless steel blade with electrolytic treatment, Bi-material handle</i> <i>Platoir lame inox avec traitement électrolytique angles arrondis manche Bi-matière</i>	304.5-20	20x8	6
	304.5-24	24x10	6
	304.5-28	28x12	6
Art. 304.5/LS	Cod.	Misura Size cm	
Lama smussata lucida <i>Blade with mirror polished radius edges</i> <i>Lame avec borde bisautés très brillante</i>	304.5/LS-20	20x8	6
	304.5/LS-24	24x10	6
	304.5/LS-28	28x12	6



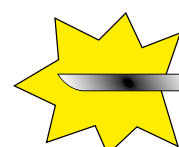

Art. 304.5

INOX
stainless steel



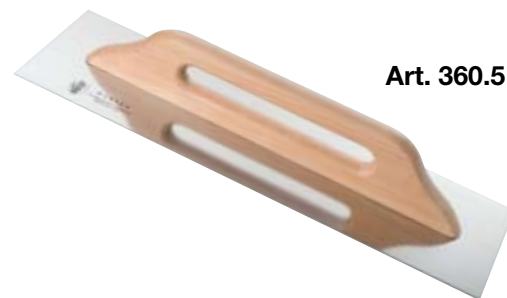

Art. 304.5/LS

Art. 360.5	Cod.	Misura Size cm	
Frattazzo per stucco, manico legno lama acciaio <i>Steel blade plastering trowel for putty with wood handle</i> <i>Taloche de platrier manche bois lame en acier</i>	360.5-12	48x12	6
	360.5-14	48x14	6
Art. 360.5/IN	Cod.	cm	
Lama Inox - <i>Stainless steel blade - Lame Inox</i>	360.5/IN	48x12	6



Art. 360.5

Art. 361.5	Lama - Blade - Lame cm 48x14	Cod.	mm 	
Frattazzo per stucco manico legno lama in acciaio dentata <i>Notched steel blade plastering trowel for putty with wood handle</i> <i>Taloche de platrier manche bois lame en acier denté</i>		361.5-5	5x5	6
		361.5-7	7x7	6
		361.5-10	10x10	6
		361.5-12	12x12	6



Art. 361.5

Art. 364.5	Cod.	Misura Size cm	
Frattazzo a punta acuta per pavimenti manico legno lama acciaio <i>Steel blade sharp pointed plastering trowel for floors with wood handle</i> <i>Platoir chapiste pointe aigue lame en acier manche bois</i>	364.5-40	40x13	6
	364.5-50	50x13	6

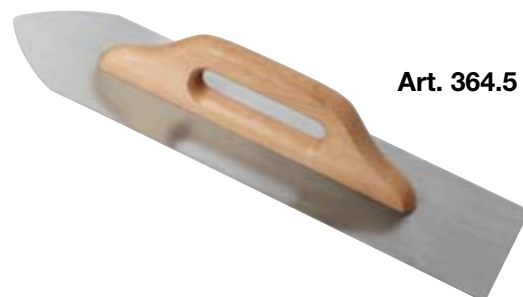

Art. 364.5

Art. 362.5	Cod.	Misura Size cm	
Frattazzo professionale a punta acuta per pavimenti, manico legno lama acciaio <i>Steel blade professional sharp pointed plastering trowel for floors with wood handle</i> <i>Platoir professionnel chapiste pointe aigue lame en acier, manche bois</i>	362.5-40	40x12	6
	362.5-45	45x12	6



Art. 362.5

Professional

Art. 363.5	Cod.	Misura Size cm	
Frattazzo professionale a punta tonda per pavimenti, manico legno, lama acciaio <i>Steel blade professionale round pointed plastering trowel for floors with wood handle</i> <i>Platoir professionnel chapiste pointe ronde lame en acier, manche bois</i>	363.5-40	40x12	6
	363.5-45	45x12	6





Art. 363.5

Professional



FRATTAZZI

Sponge rubber - Talocche éponge

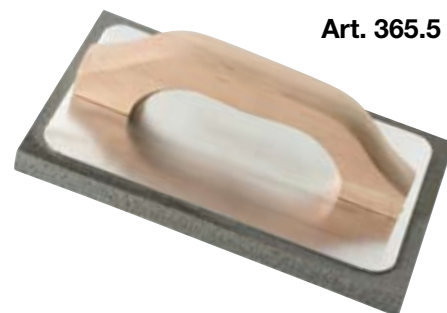
Art. 365.5	Cod.	Misura Size cm	📦
Frattazzo gommaspugna grigia manico legno	365.5-21	21x14	32
<i>Grey sponge float with wood handle</i>	365.5-24	24x10	32
<i>Talocche éponge gris manche bois</i>	365.5-28	28x14	32
Art. 365.5/O 	Art. 365.5/B 		



Art. 365.5

Art. 366.5	Cod.	Misura Size cm	📦
Frattazzo gommaspugna grigia manico simil legno	366.5-21	21x14	32
<i>Grey sponge float with similar wood handle</i>	366.5-24	24x10	32
<i>Talocche éponge gris manche semblable bois</i>	366.5-28	28x14	32
Art. 366.5/O 	Art. 366.5/B 		



Art. 366.5

Art. 367.5	Cod.	Misura Size cm	📦
Frattazzo per fughe supporto in polistirolo antiurto base in gomma blu	367.5	25x11	12
<i>Stiff rubber float with shock proof polystyrene mounting for tiles covering</i>			
<i>Talocche à Joint smelle caoutchouc monture en polystyrène antichoc</i>			



Art. 367.5

Art. 368.5	Cod.	Misura Size cm	📦
Frattazzo gommaspugna per angoli	368.5	35x7x5	10
<i>Corner sponge rubber plastering trowel</i>			
<i>Talocche éponge triangulaire</i>			

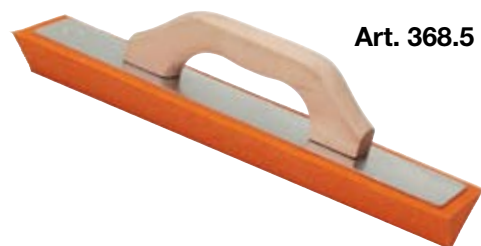

Art. 368.5

Art. 369.5	Cod.	Misura Size cm	Misura Size inch	📦
Sparviero in alluminio manico plastica	369.5	30x30	12"x12"	12
<i>Aluminium hawk with plastic handle</i>				
<i>Talocche modèle "hawk" lame en aluminium manche plastique</i>				



Art. 369.5

FRATTAZZI

Sponge rubber - Talocche éponge

Art. 370.5	Cod.	Misura Size cm	📦
Fratteggio in poliuretano espanso misure medio grandi	370.5-14	40x14	50
<i>Polyurethane float big sizes</i>	370.5-45	45x14	40
<i>Talocche en polyuréthane grand tailles</i>	370.5-22	40x22	30
	370.5-25	40x25	25
	370.5-30	40x30	20



Art. 370.5

Art. 371.5	Cod.	Misura Size cm	📦
Fratteggio in poliuretano espanso modello internazionale con impugnatura arrotondata	371.5-14	28x14	40
<i>Polyurethane float with round handle international model</i>			
<i>Talocche en polyuréthane modèle international avec poignée arrondis</i>			



Art. 371.5

Art. 372.5	Cod.	Misura Size cm	📦
Fratteggio per pulizia piastrelle supporto in polistirolo antiurto con 2 tamponi intercambiabili in fibra	372.5-12	25x12x4,5	25
<i>Interchangeable two fibre pad float to clean tiles with polystyrene mounting</i>			
<i>Talocche de nettoyage avec deux smelle en fibre et monture en polystyrène interchangeable</i>			



Art. 372.5

Art. 373.5	Cod.	Misura Size cm	📦
Fratteggio per pulizia supporto intercambiabile base gommaspugna color tabacco o gialla	373.5-15	29x15x4	30
<i>Yellow or tobacco sponge cleaning float with interchangeable mounting</i>	373.5-15/G	29x15x4	30
<i>Talocche de nettoyage smelle éponge jaune au tabac monture interchangeable</i>			



Art. 373.5

Art. 374.5	Cod.	Misura Size cm	📦
Fratteggio per pulizia in polistirolo antiurto, base in gommaspugna tabacco o gialla	374.5-15	29x15x4	30
<i>Yellow or tobacco sponge cleaning float with shock proof polystyrene mounting</i>	374.5-15/G	29x15x4	30
<i>Talocche de nettoyage smelle éponge jaune au tabac monture en polystyrène antischoc</i>			



Art. 374.5

PIALLE GESSO

Rabot

Art. 375.5	Cod.	Misura Size cm	
Pialla per gesso rabot in legno <i>Wood rabot for gypsum</i> <i>Rabot de platrier manche bois</i>	375.5-6 375.5-7	42x6 47x7	2 2



Art. 375.5

Art. 376.5	Cod.	Misura Size cm	
Pialla per gesso rabot in alluminio <i>Aluminium rabot for gypsum</i> <i>Rabot de platrier en aluminium</i>	376.5	47x8	1

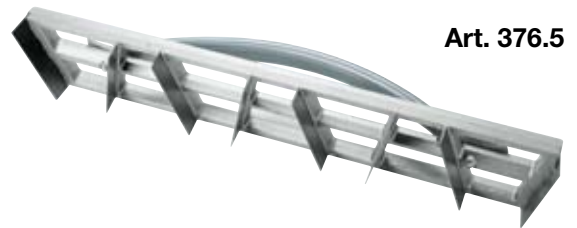

Art. 376.5

Art. 377.5	Cod.	Misura Size cm	
Pialla a griglia manico gomma <i>Grid rabot for gypsum with rubber handle</i> <i>Rabot de platrier à grille manche caoutchouc</i>	377.5	28x14	4



Art. 377.5

Art. 378.5	Cod.	Misura Size cm	
Rasatore per intonaco piastra zincata manico in polipropilene espanso <i>Zinc-plated scraper with polypropylene handle</i> <i>Taloche gratton zingué poingée en polypropylene</i>	378.5	25x15	10



Art. 378.5

Art. 380.5	
Ginocchiera professionale in poliuretano espanso corta con elastici in para <i>Short professional polyuretane knee-pad with soft adjustable straps</i> <i>Genouillère professionell petit en poliurethane avec courroies réglables</i>	30



Art. 380.5

Art. 381.5	
Ginocchiera professionale in PVC a soffiutto <i>Professional PVC folding knee pad with mousse inside</i> <i>Genouillère professionell pliant en PVC avec mousse à l'intérieur</i>	20



Art. 381.5

SPATOLE

Scraper - Couteau à enduire

Art. 244.6	Cod.	Misura Size cm	Cod.	Misura Size cm	📦
Spatola per stucco manico legno verniciato <i>Scraper with varnished wood handle</i> <i>Couteau peintre manche bois verni</i>	244.6-2	2	244.6-7	7	12
	244.6-3	3	244.6-8	8	12
	244.6-4	4	244.6-9	9	12
	244.6-5	5	244.6-10	10	12
	244.6-6	6	244.6-12	12	12

Art. 244.6



Art. 245.6	Cod.	Misura Size cm	Cod.	Misura Size cm	📦
Spatola professionale per stucco, manico legno <i>Professional scraper with wood handle</i> <i>Couteau peintre professionnel manche bois</i>	245.6-2	2	245.6-9	9	12
	245.6-3	3	245.6-10	10	12
	245.6-4	4	245.6-11	11	12
	245.6-5	5	245.6-12	12	12
	245.6-6	6	245.6-13	13	12
	245.6-7	7	245.6-14	14	12
	245.6-8	8			12

Art. 245.6



Art. 247.6	Cod.	Misura Size cm	Cod.	Misura Size cm	📦
Spatola per stucco manico plastica lama inox <i>Stainless steel scraper with plastic handle</i> <i>Couteau peintre manche plastique lame inox</i>	247.6-3	3	247.6-9	9	12
	247.6-4	4	247.6-10	10	12
	247.6-5	5	247.6-12	12	12
	247.6-6	6	247.6-14	14	12
	247.6-8	8			12

Art. 247.6



Art. 250.6	Cod.	Misura Size cm	📦
Spatola per raschiare lama rigida in acciaio smussata con spessore di 2 mm <i>Plastic handle scraper with bevelled edge thickness 2 mm</i> <i>Couteau à enduire manche plastique lame bisautés épaisseur 2 mm</i>	250.6-75	7,5	12
	250.6-10	10	12

Art. 250.6



Art. 249.6	Cod.	Misura Size cm	📦
Spatola multiuso lama rigida con spessore di 2 mm <i>Plastic handle multipurpose scraper blade thickness 2 mm</i> <i>Couteau à enduire a usages multiples lame épaisseur 2 mm</i>	249.6	6	12

Art. 249.6



SPATOLE

Scraper - Couteau à enduire

Art. 248.6	Cod.	Misura Size cm	Cod.	Misura Size cm	📦
Spatola per soffitto <i>Taping knife with plastic handle</i> Couteau à enduire manche plastique	248.6-12	12	248.6-20	20	12
	248.6-14	14	248.6-22	22	12
	248.6-16	16	248.6-24	24	12
	248.6-18	18			12
Art. 248.6/IN	Cod.	Misura Size cm	Cod.	Misura Size cm	📦
Spatola inox per soffitto <i>Taping knife stainless steel with plastic handle</i> Couteau à enduire inox manche plastique	248.6-12/IN	12	248.6-20/IN	20	12
	248.6-14/IN	14	248.6-22/IN	22	12
	248.6-16/IN	16	248.6-24/IN	24	12
	248.6-18/IN	18			12



Art. 248.6

INOX
stainless steel

Art. 248.6/IN

Art. 251.6 (Set cm 5-8-10-12)	Cod.	📦
Set spatole da carrozziere in plastica <i>Set plastic square scrapers</i> Set cauteau peintre plastic carrée	251.6	12



Art. 251.6

Art. 252.6	Cod.	Misura Size cm	📦
Spatola per carrozziere <i>Square scraper</i> Cauteau peintre carrée	252.6-4	4	12
	252.6-6	6	12
	252.6-8	8	12
	252.6-10	10	12
	252.6-12	12	12-



Art. 252.6

Art. 435.6	Cod.	mm	inch	📦
Flat combination Slicker	435.6-1/4	7/9	1/4" x 3/8"	12
	435.6-3/8	9/13	3/8" x 1/2"	12
	435.6-1/2	13/16	1/2" x 5/8"	12
	435.6-5/8	16/19	5/8" x 3/4"	12
	435.6-3/4	19/22	3/4" x 7/8"	12
	435.6-7/8	22/25	7/8" x 1"	12



Art. 435.6

Art. 436.6	Cod.	mm	inch	📦
Concave jointer	436.6-3/8	10/13	3/8" x 1/2"	12
	436.6-5/8	16/19	5/8" x 3/4"	12



Art. 436.6

Art. 437.6	Cod.	Misura Size inch	📦
Cazzuolino Margin dentato 1/4" x 1/4" <i>Notched Margin trowel 1/4" x 1/4"</i> Truelle Margin denté 1/4" x 1/4"	437.6	5" x 2"	12

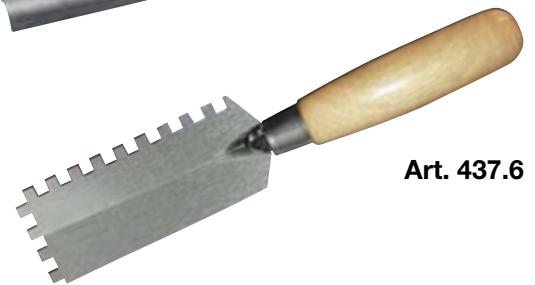

Art. 437.6

Art. 438.6	Cod.	Misura Size mm	Cod.	Misura Size mm	📦
Scalpello per falegname forgiato manico legno <i>Forged woodworker chisel with wood handle</i> Ciseau de menuisier forgé manche bois	438.6-6	6	438.6-18	18	12
	438.6-8	8	438.6-20	20	12
	438.6-10	10	438.6-22	22	12
	438.6-12	12	438.6-26	26	12
	438.6-14	14	438.6-30	30	12
	438.6-16	16	438.6-32	32	12





Art. 438.6

MISCELATORI



Mixer

Art. 501.7 ø 10 mm	Cod.	Misura Size mm	
Miscelatore a doppia elica <i>Double spiral paint mixer</i> <i>Melangeur</i>	501.7-10	100x480	6
	501.7-12	120x600	6
	501.7-13	135x600	6

Art. 502.7	Cod.	Misura Size mm	
Miscelatore a elica <i>Spiral paint mixer</i> <i>Melangeur</i>	502.7.85	85x422	12
	502.7.120	120x613	12

Art. 503.7 ø 14 mm	Cod.	Misura Size mm	
Miscelatore a doppia elica <i>Double spiral paint mixer</i> <i>Melangeur</i>	503.7-12	120x600	6
	503.7-13	135x600	6

Art. 504.7 ø 8 mm	Cod.	Misura Size mm	
Miscelatore a frusta <i>Egg beater mixer</i> <i>Melangeur</i>	504.7-60	120x600	12

Art. 505.7	Cod.	
Intonacatrice banda stagnata <i>Tinned-sheet sprayer machine</i> <i>Machine à crépir tôle étamée</i>	505.7	1
Art. 505.7/B	Cod.	
Intonacatrice banda ottonata <i>Brass-plated sheet sprayer machine</i> <i>Machine à crépir tôle laitonée</i>	505.7/B	1
Art. 505.7/R	Cod.	
Rulli di ricambio <i>Spare combs for sprayer machine</i> <i>Peigne de rechange pour machine à crépir</i>	505.7/R	12

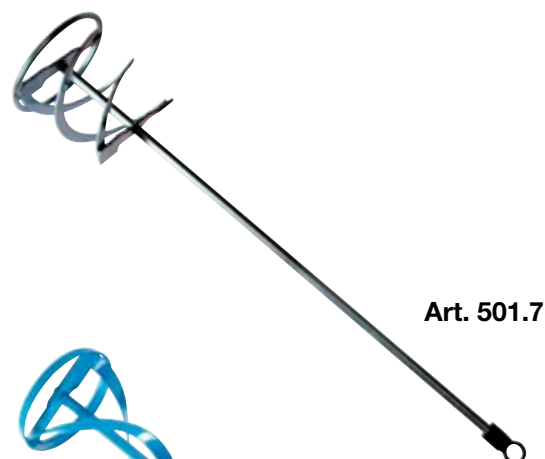

Art. 501.7



Art. 502.7

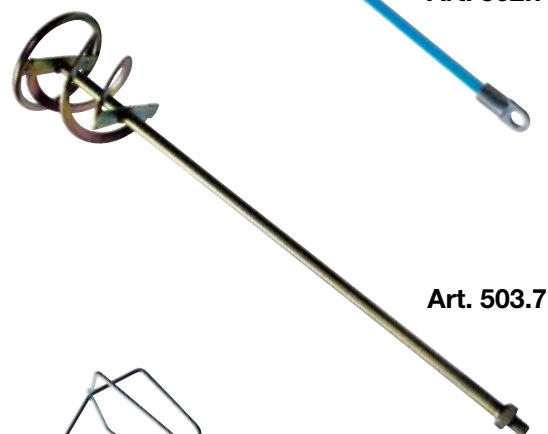

Art. 503.7

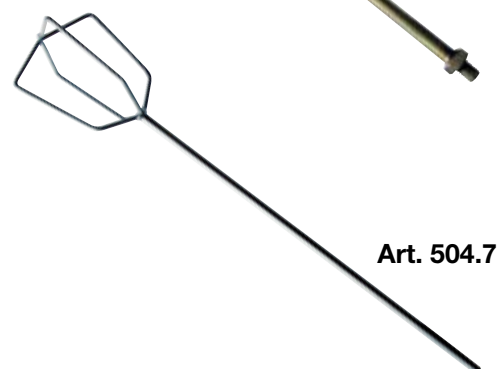

Art. 504.7



Art. 505.7

ARCHEOLOGIA

Archaeology - Archeology

Art. 289.4/A	manico legno wood handle manche bois	Misura Size cm	Misura Size inch	
Cazzuolino archeologia forgiato lama rigida con spessore mm 1,2 <i>Forged archaeology pointing trowel blade thickness mm 1,2</i> <i>Truelle archeologique forgé lame épaisseur mm 1,2</i>		11	4-1/2"	12



Art. 289.4/A

Art. 289.4/AS	manico legno wood handle manche bois	Misura Size cm	Misura Size inch	
Cazzuolino archeologia forgiato con bordi smussati spessore lama mm 1,2 <i>Forged archaeology pointing trowel with sharpened edges blade thickness mm 1,2</i> <i>Truelle archeologique forgé lame aigue épaisseur mm 1,2</i>		11	4-1/2"	12



Art. 289.4/AS

Art. 288.4/A	manico legno wood handle manche bois	Misura Size Inch	
Cazzuolino archeologia forgiato Margin <i>Forged archaeology Margin trowel</i> <i>Truelle archeologique forge Margin</i>		5x1-1/2" 5x2"	12 12



Art. 288.4/A

Art. 308.8/A	Misura Size mm	Misura Size Inch	
Ferri archeologia forgiati foglia e quadro <i>Forged archaeology tools leaf and square</i> <i>Outils archeologique forgé feuille et carrée</i>	13	1/2"	12

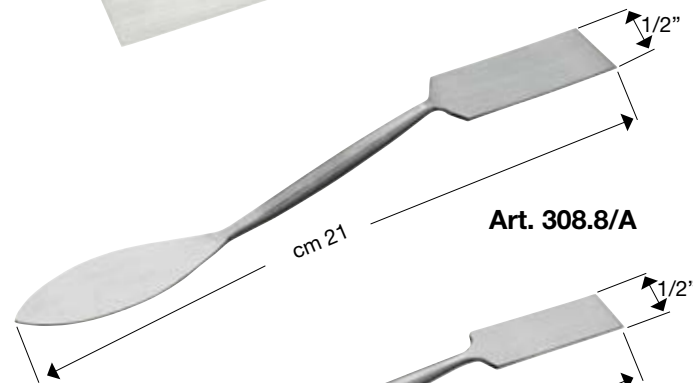

Art. 308.8/A

Art. 314.8/A	Misura Size mm	Misura Size inch	
Ferri per archeologia forgiati cazzuola e quadro <i>Forged archaeology trowel and square</i> <i>Outils archeologique forgé truelle et carrée</i>	13	1/2"	12

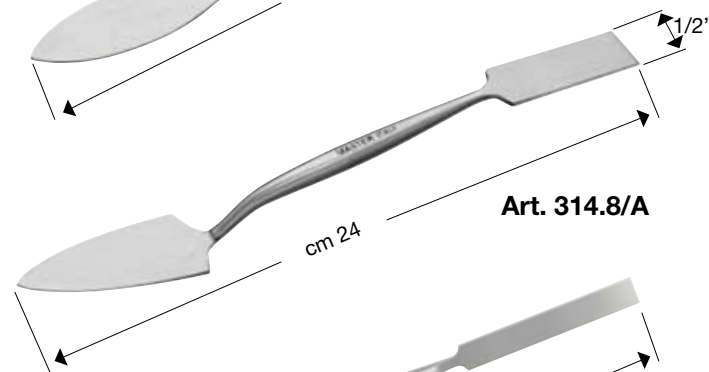

Art. 314.8/A

Art. 385.8/A	Misura Size cm	
Ferri per archeologia forgiati lancia e quadro <i>Forged archaeology tools lance and square</i> <i>Outils archeologique forgé lance et carrée</i>	23	12

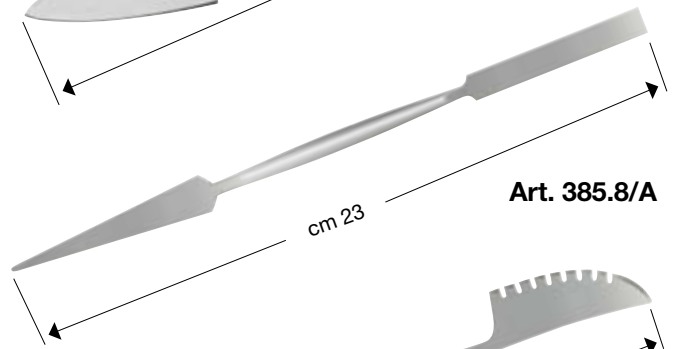

Art. 385.8/A

Art. 381.8/A	Misura Size cm	
Ferri per archeologia forgiati doppio coltello dentato <i>Forged archaeology tools cut and share</i> <i>Outils archeologique forgé lame denté</i>	23	12

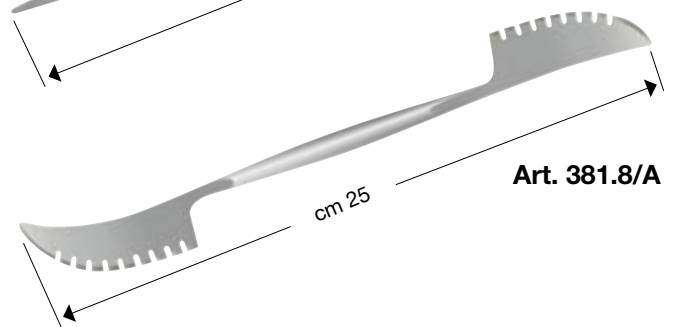

Art. 381.8/A

FERRI PER MODELLATORI

Forged ornamental tools - Outils modelage forgé

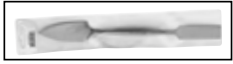

Art. 0.55 - PVC Sheet

cm 24



Art. 307.8

Doppia lama mezzatonda
Radius shaping tool



Art. 308.8

Foglia e quadro - Leaf and square



	3/8"	1/2"	5/8"	3/4"	1"
mm.	10	13	16	19	25



Art. 310.8

Foglia e quadro gambo plastica
Leaf and square plastic stem



	3/8"	5/8"	3/4"	1"	1 1/4"
mm.	10	16	19	25	32



Art. 314.8

Cazzuola e quadro - Trowel and square



	3/8"	1/2"	5/8"	3/4"	7/8"	1"
mm.	10	13	16	19	22	25



cm 25

Art. 380.8

Foglia e oliva - Leaf and olive

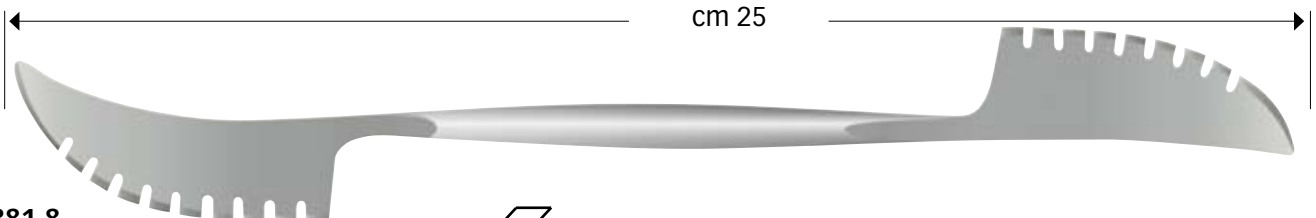

cm 25

Art. 381.8

Doppio coltello dentato - Cut and shape tool



FERRI PER MODELLATORI

Forged ornamental tools - Outils modelage forgé



Art. 0.55 - PVC Sheet



Art. 382.8

Foglia e foglia - Leaf and leaf

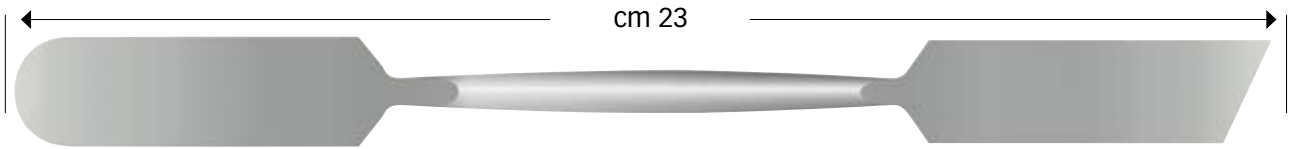

Art. 383.8

Tondo e quadro diagonale - Round and diagonal square



Art. 384.8

Quadro e quadro - Square and square



Art. 385.8

Lancia e quadro - Lance and square



FERRI PER RESTAURO - CARVING TOOLS

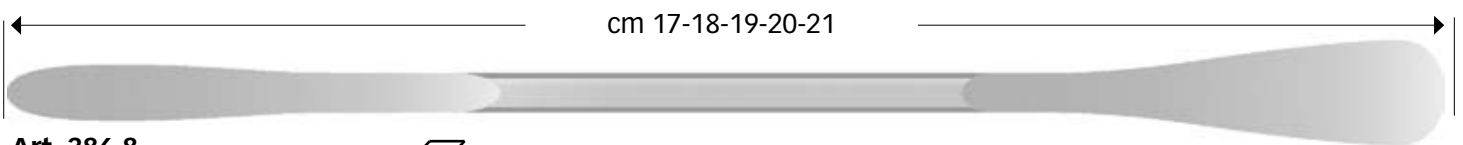

Art. 386.8

Foglia e foglia - Leaf and leaf

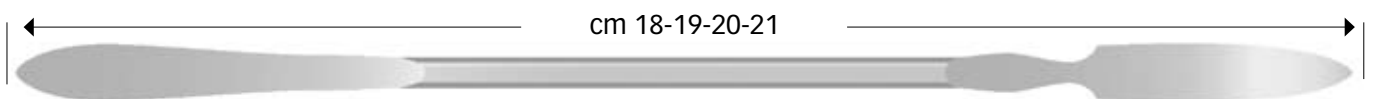

Art. 387.8

Foglia e uncino - Leaf and hook

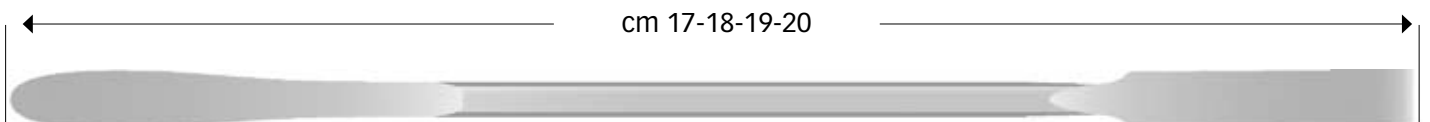

Art. 388.8

Foglia e scalpello - Leaf and chisel



SPATOLINE PER PITTORI

Palette knives - Couteaux à peintre

Carbon steel C 70 - Inox - Stainless Steel "AISI 420"

SCALE 1:1



Art. 601.9

Carbon steel

Art. 601.9/IN

Inox - Stainless steel



Art. 607.9

Carbon steel

Art. 607.9/IN

Inox - Stainless steel



Art. 602.9

Carbon steel

Art. 602.9/IN

Inox - Stainless steel



Art. 608.9

Carbon steel

Art. 608.9/IN

Inox - Stainless steel



Art. 603.9

Carbon steel

Art. 603.9/IN

Inox - Stainless steel



Art. 609.9

Carbon steel

Art. 609.9/IN

Inox - Stainless steel



Art. 604.9

Carbon steel

Art. 604.9/IN

Inox - Stainless steel



Art. 610.9

Carbon steel

Art. 610.9/IN

Inox - Stainless steel



Art. 605.9

Carbon steel

Art. 605.9/IN

Inox - Stainless steel



Art. 611.9

Carbon steel

Art. 611.9/IN

Inox - Stainless steel



Art. 606.9

Carbon steel

Art. 606.9/IN

Inox - Stainless steel

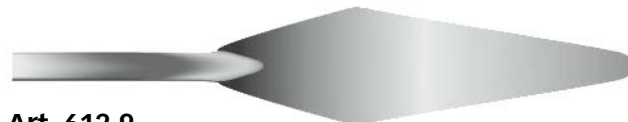

Art. 612.9

Carbon steel

Art. 612.9/IN

Inox - Stainless steel



SPATOLINE PER PITTORI

Palette knives - Couteaux à peintre

Carbon steel C 70 - Inox - Stainless Steel "AISI 420"

SCALE 1:1

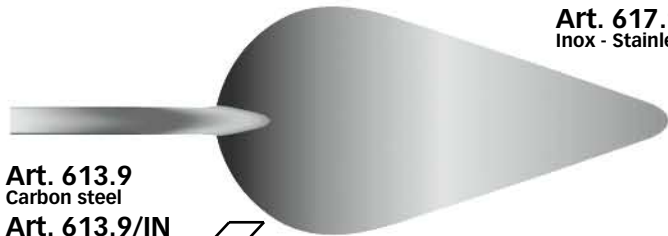

Art. 613.9
Carbon steel
Art. 613.9/IN
Inox - Stainless steel

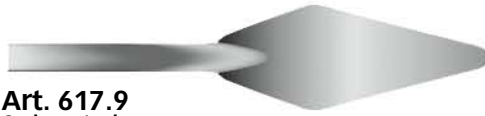

Art. 617.9
Carbon steel
Art. 617.9/IN
Inox - Stainless steel



Art. 618.9
Carbon steel
Art. 618.9/IN
Inox - Stainless steel



Art. 614.9
Carbon steel
Art. 614.9/IN
Inox - Stainless steel



Art. 619.9
Carbon steel
Art. 619.9/IN
Inox - Stainless steel



Art. 615.9
Carbon steel
Art. 615.9/IN
Inox - Stainless steel



Art. 620.9
Carbon steel
Art. 620.9/IN
Inox - Stainless steel



Art. 616.9
Carbon steel
Art. 616.9/IN
Inox - Stainless steel



Art. 621.9
Carbon steel
Art. 621.9/IN
Inox - Stainless steel



SPATOLINE PER PITTORI

Palette knives - Couteaux à peintre

Carbon steel C 70 - Inox - Stainless Steel "AISI 420"

SCALE 1:1



Art. 622.9 - Carbon steel
Art. 622.9/IN - Inox - Stainless steel



Art. 623.9 - Carbon steel
Art. 623.9/IN - Inox - Stainless steel



Art. 624.9 - Carbon steel
Art. 624.9/IN - Inox - Stainless steel



Art. 625.9 Side View

Art. 625.9 - Carbon steel
Art. 625.9/IN - Inox - Stainless steel

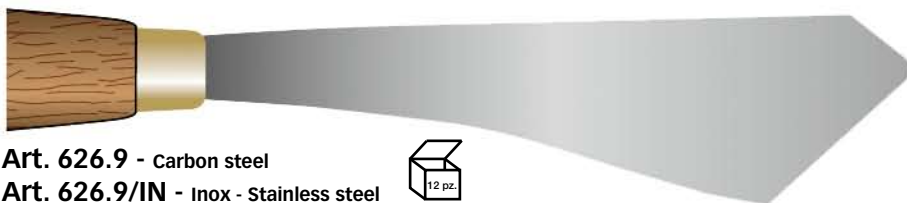

Art. 626.9 - Carbon steel
Art. 626.9/IN - Inox - Stainless steel



Art. 627.9 - Carbon steel
Art. 627.9/IN - Inox - Stainless steel



Art. 628.9 - Carbon steel
Art. 628.9/IN - Inox - Stainless steel



SPATOLINE PER PITTORI

Palette knives - Couteaux à peintre

Carbon steel C 70 - Inox - Stainless Steel "AISI 420"

SCALE 1:1



Art. 629.9 - Carbon steel

Art. 629.9/IN - Inox - Stainless steel



Art. 630.9 - Carbon steel

Art. 630.9/IN - Inox - Stainless steel



Art. 631.9 - Carbon steel

Art. 631.9/IN - Inox - Stainless steel



Art. 632.9 - Carbon steel

Art. 632.9/IN - Inox - Stainless steel



Art. 633.9 - Carbon steel

Art. 633.9/IN - Inox - Stainless steel



Art. 634.9 - Carbon steel

Art. 634.9/IN - Inox - Stainless steel



PALE E PICCONI

Shovels and picks - Pelles et pioches

Art. 701.10	Cod.	Misura Size cm	
Badile a punta temprato <i>Hardened shovel with pointed end</i> <i>Pelle trempé pointu</i>	701.10-28 701.10-29	28x27 29,7x28,5	12 12



Art. 701.10

Art. 702.10	Cod.	Misura Size cm	
Badile a punta tonda temprato <i>Round pointed hardened shovel</i> <i>Pelle trempé à bout ronde</i>	702.10-27 702.10-29	27 29	12 12



Art. 702.10

Art. 703.10	Cod.	Misura Size cm	
Badile a collo di cigno temprato modello Francese <i>Swan neck hardened shovel French pattern</i> <i>Pelle trempé à col de cigne modèle Française</i>	703.10-27 703.10-29	27 29	12 12

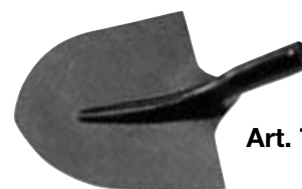

Art. 703.10

Art. 704.10	Cod.	Misura Size cm	
Badile a punta quadra temprato <i>Square pointed tempered shovel</i> <i>Pelle trempé à bout carrée</i>	704.10-27	27	12



Art. 704.10

Art. 705.10	Cod.	Peso weight gr.	Misura Size cm	
Piccone con foro ovale <i>Oval eye pick</i> <i>Pioche avec oeil ovale</i>	705.10-15 705.10-18	1500 1800	90 90	6 6



Art. 705.10

Art. 706.10	Cod.	Peso weight gr.	Misura Size cm	
Piccone con foro tondo <i>Round eye pick</i> <i>Pioche avec oeil ronde</i>	706.10-20 706.10-25	2000 2500	90 90	6 6



Art. 706.10

MARTELLERIA

Hammers - Martellerie

Art. 707.10	Cod.	Misura Size kg	
Mazza con manico in legno di faggio cm 90	707.10-3	3	4
<i>Sledge hammer beechwood handle length cm 90</i>	707.10-4	4	4
	707.10-5	5	4
<i>Masse avec manche en bois de hêtre longueur cm 90</i>	707.10-6	6	4
	707.10-8	8	4



Art. 707.10

Art. 708.10	Cod.	Misura Size kg	
Mazza senza manico	708.10-3	3	1
<i>Sledge hammer without handle</i>	708.10-4	4	1
<i>Masse sans manche</i>	708.10-5	5	1
	708.10-6	6	1



Art. 708.10

Art. 709.10	Cod.	Misura Size gr	
Mazzetta da muratore con manico in legno di faggio cm 28	709.10-8	800	6
	709.10-10	1000	6
<i>Stone hammer beechwood handle length cm 28</i>	709.10-12	1200	6
	709.10-15	1500	6
<i>Massette de maçon avec manche en bois de hêtre longueur cm 28</i>	709.10-20	2000	6



Art. 709.10

Art. 710.10	Cod.	Misura Size cm	
Manico in legno di faggio per pala	710.10	140	12
<i>Beechwood handle for shovel</i>			
<i>Manche en bois de hêtre pour pelle</i>			



Art. 710.10

Art. 711.10	Cod.	Misura Size cm	
Manico in legno di faggio per piccone foro ovale	711.10	95	12
<i>Beechwood handle oval eyer for pick</i>			
<i>Manche en bois de hêtre avec oeil ovale pour pioche</i>			



Art. 711.10

Art. 712.10	Cod.	Misura Size cm	
Manico in legno di faggio per piccone foro tondo	712.10	95	12
<i>Beechwood handle round eyer for pick</i>			
<i>Manche en bois de hêtre avec oeil ronde pour pioche</i>			



Art. 712.10

Art. 713.10	Cod.	Misura Size cm	
Manico in legno di faggio per mazza	713.10	90	12
<i>Beechwood handle for sledge hammer</i>			
<i>Manche en bois de hêtre pour masse</i>			



Art. 713.10

Art. 714.10	Cod.	Misura Size cm	
Manico in legno di faggio per mazzetta	714.10	28	12
<i>Beechwood handle for stone hammer</i>			
<i>Manche en bois de hêtre pour massette de maçon</i>			



Art. 714.10

BATIFERRO DI MANIAGO 
Cazzuole/Trowels - Frattoni/Plastering Trowels
Attrezzi per Muratori/Masonry Tools

33085 Maniago/PN Italy
P.O. Box 126 - Uffici/Offices: Via Europa, 23
Tel. +39 0427 71065 - Fax +39 0427 71447
E-mail: info@battiferro.it - Sito web: www.battiferro.it