



Technical Data

Specification & Capacities

SPX312

S.N: _____



CP: 7,6kW/10,4Hp



C+: 4,0kW/5,5Hp



2,2 - 7,6m



1200kg



EN 13000

[m] [kg]



SPX312



Via Campardone, 1
31014 Colle Umberto – Italy
Tel. +39 0438 1710083
Mail: info@jekko.it
Web: www.jekko.it

Date	Jan. 30 th 2018
REV.	19





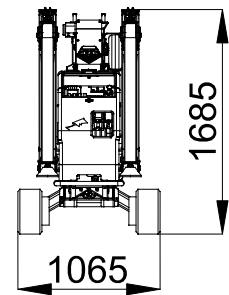
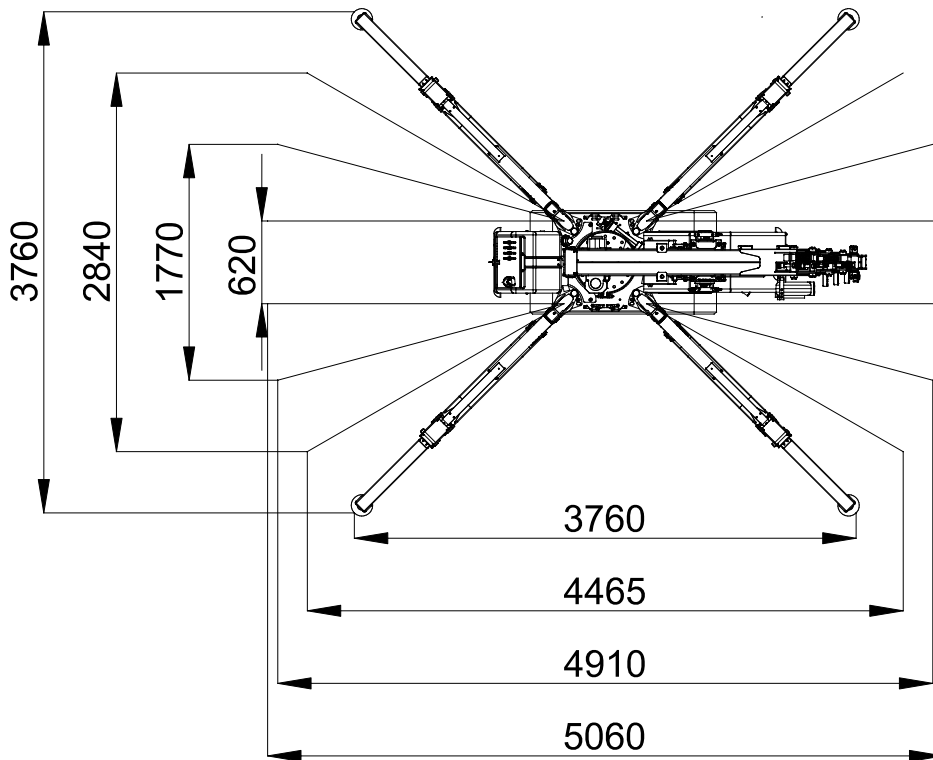
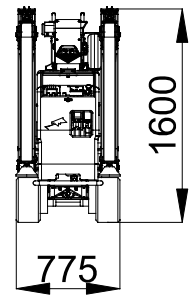
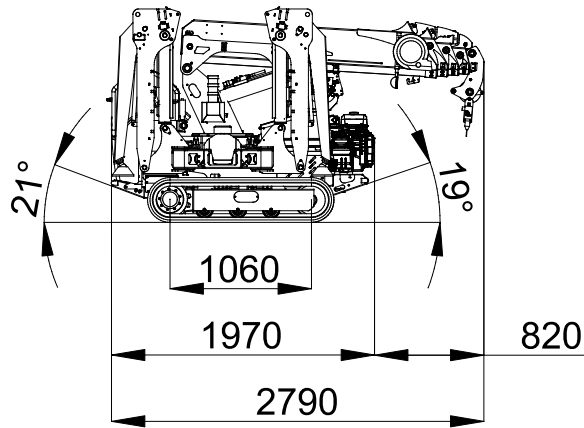

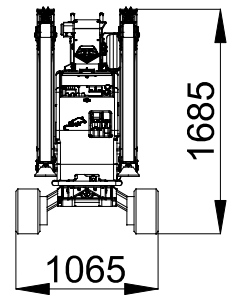
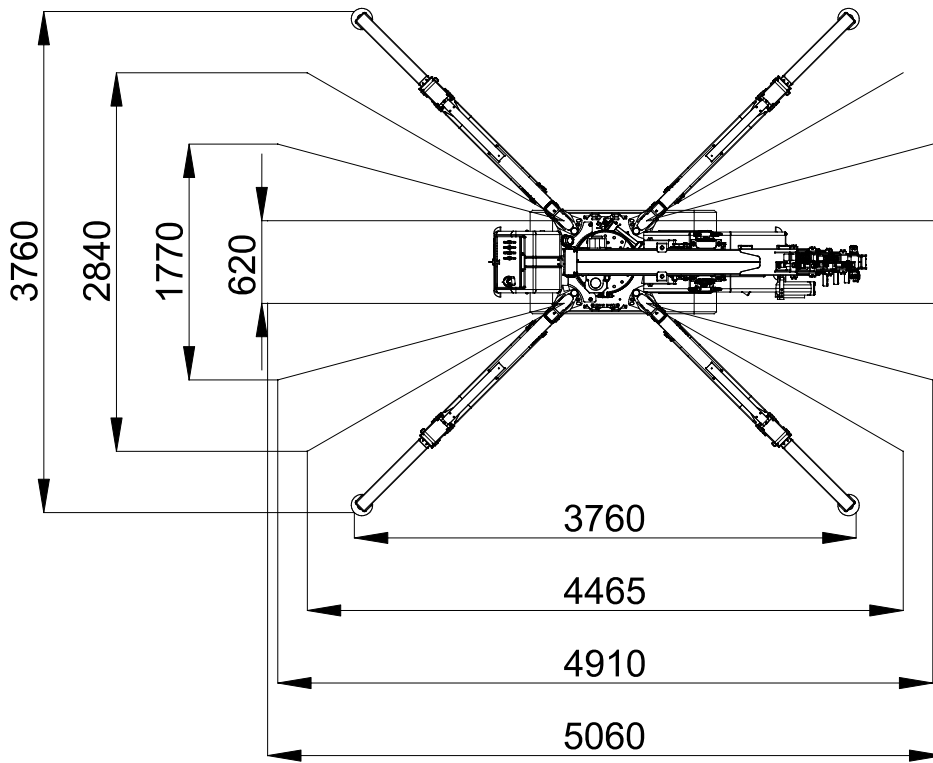
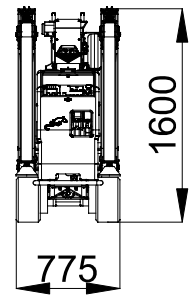
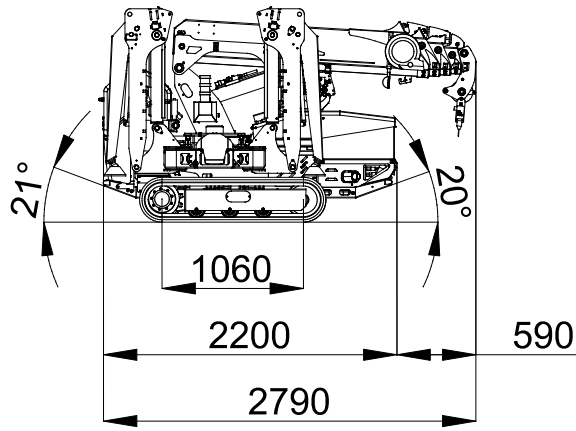

SPX312 - OVERALL DIMENSIONS

SPX312CP

















SPX312C+



WEIGHTS		Name / version	kg ¹
		CP, C+	1800
		-	0
		SINGLE FALL	27
		MULTIPLE FALL	20
		POWERPACK	45
		800GX	25
		400.1MX	58
		MV600	200
		OM300	17
	WUK-01	1,5	

- ¹: Dry weight
- ²: Engine working limit
- ³: Static lifting

ENGINE		YAMAHA MZ360	
		7,6kW 10,4Hp	
		PETROL	
		L	6,7
ELECTRIC		24V 240Ah	
		24V-3F 4,0kW 5,5HP	
HYDRAULIC		ISO 6743-4:HFDU with VG46 viscosity class	
		Working temp	<70°C
		L	20
MOVEMENTS		km/h	CP: 1,7 C+: 0,85
		20° (36%) ²	
		kg/cm ²	0,44
		kg	1850 ³
		0°/75°	
		s	24
		330°	
		rpm	1,0
		m	2,2 - 7,6
		s	40

HOIST PERFORMANCE	Winch	Layer	Max line pull	Standard rope speed	Highest rope speed
			kg	m/min	m/min
		1	742 ¹	12,2	25,7
		2	690 ¹	13,3	28,0
		3	638 ¹	14	29,5
	4	600	15,1	31,8	
	Rope	Wire rope	Ø	Total lenght	Max load
		A4L 19x7 right lang lay	mm	m	kg
			7	63	3600
	Hook block	Load	N° of		Block type
kg		Sheaves	Lines		
1200		1	2	Multiple fall block	
600		-	1	Single fall block	

¹:LMI limited at 600 kg



SPX312 MAIN BOOM

100%



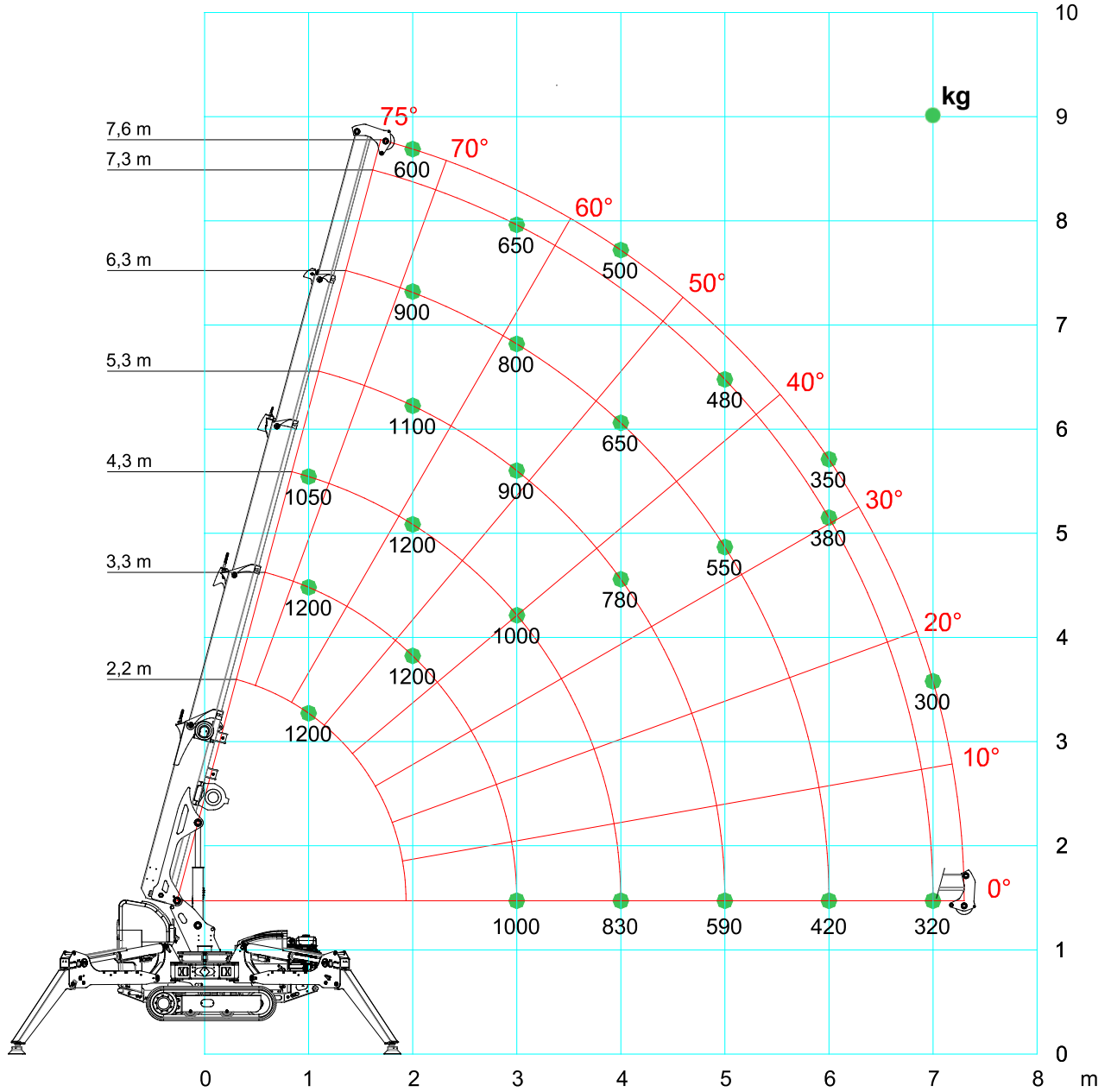

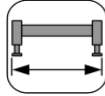
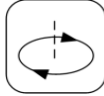
330°

0 kg

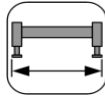
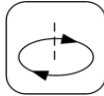

[m] [kg]							
	MAIN BOOM	100%	330°	0kg			
	2,2	3,3	4,3	5,3	6,3	7,3	7,6
1	1200	1200	1050				
2		1200	1200	1100	900	650	600
3		1000	1000	900	800	650	600
4			830	780	650	550	500
5				590	550	480	400
6					420	380	350
7						320	300
7,3							300

LC312_V400_0316_BP_FUNE_STAB_100

[m] [kg]							
	MAIN BOOM	50%	330°	0kg			
	2,2	3,3	4,3	5,3	6,3	7,3	7,6
1	1200	1200	1050				
2		1050	1050	950	800	550	500
3		900	900	800	720	550	500
4			520	490	390	330	300
5				340	320	270	220
6					250	220	200
7						180	180
7,3							150

LC312_V400_0316_BP_FUNE_STAB_50



SPX312 + JIB800GX

100%

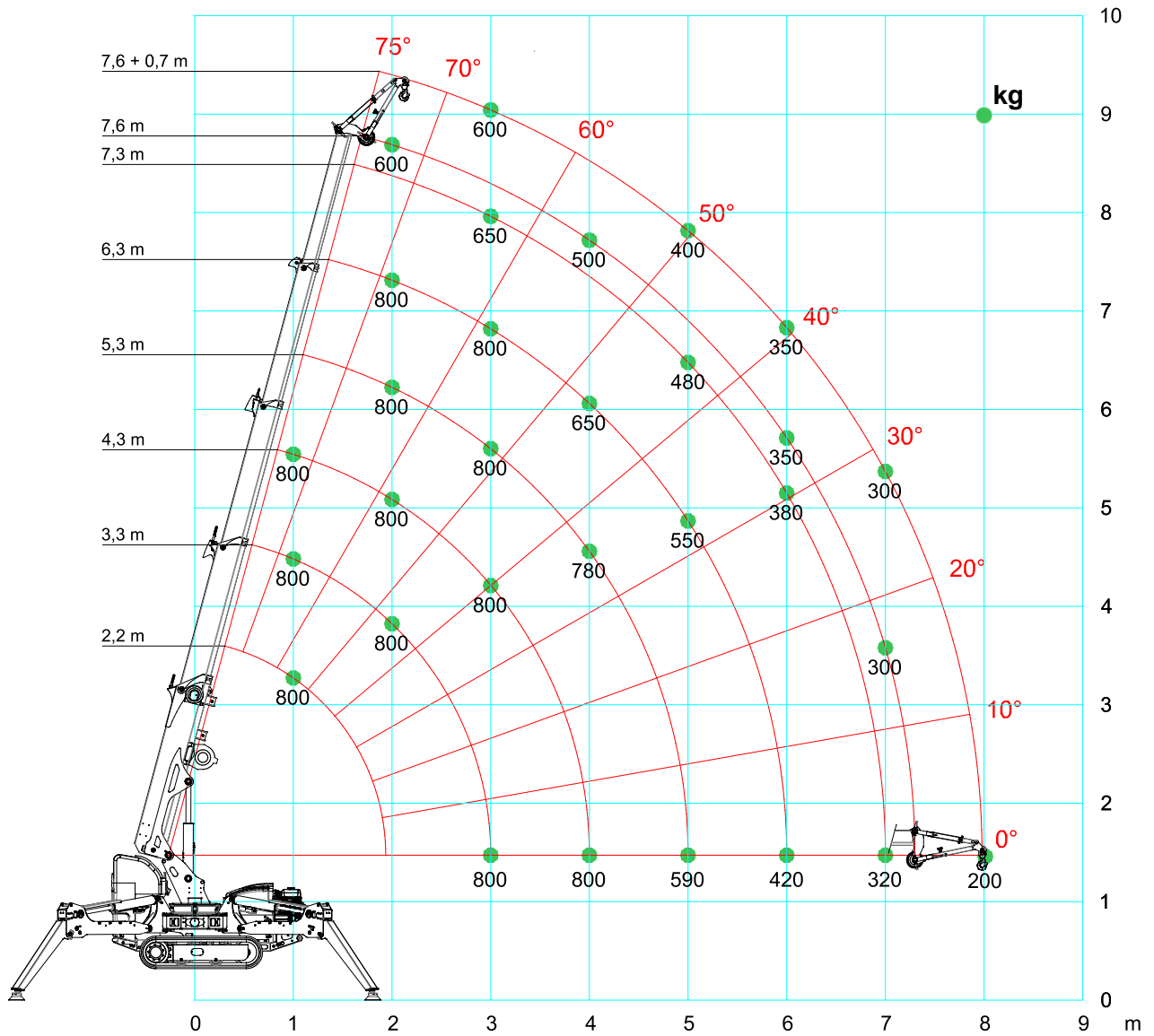

330°

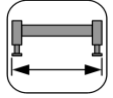
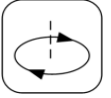
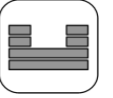
0 kg

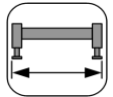
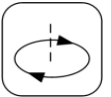
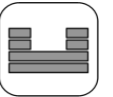

[m] \ [kg]							
	JIB800GX	100%	330°	0kg			
	2,2	3,3	4,3	5,3	6,3	7,3	7,6
1	800	800	800				
2		800	800	800	800	650	600
3		800	800	800	800	650	600
4			800	780	650	550	500
5				590	550	480	400
6					420	380	350
7						320	300
8							200

LC312_V400_0316_RUNNER_GANCIO_STAB_100

[m] \ [kg]							
	JIB800GX	50%	330°	0kg			
	2,9	3,3	4,3	5,3	6,3	7,3	8,3
1	800	800	800				
2		800	800	800	800	550	500
3		800	800	800	720	550	500
4			520	490	390	330	300
5				340	320	270	220
6					250	220	200
7						180	180
8							100

LC312_V400_0316_RUNNER_GANCIO_STAB_50



SPX312 + JIB400.1MX

100%

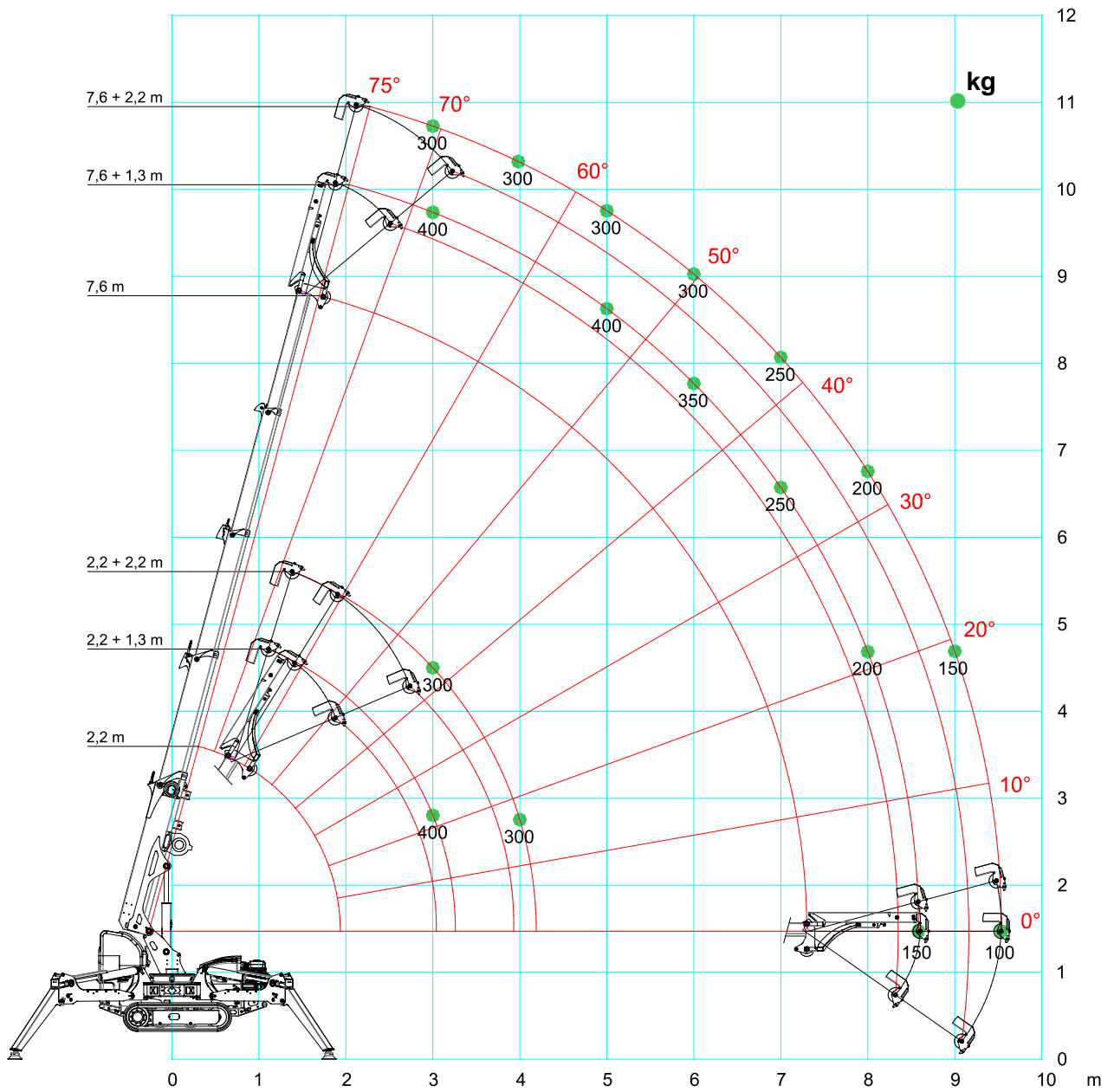

330°

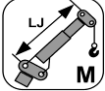
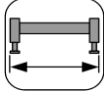
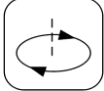
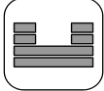
0 kg

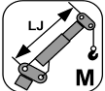
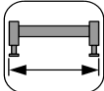
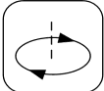

[m] \ [kg]	 JIB400.1MX	 100%	 330°	 0kg	 EN
	1,3	2,2			
2	400	300			
3	400	300			
4	400	300			
5	400	300			
6	350	300			
7	250	250			
8	200	200			
8,6	150	150			
9,6		100			

LC312_V400_0316_RUNNER_GANCIO_STAB_100

[m] \ [kg]	 JIB400.1MX	 50%	 330°	 0kg	 EN
	1,3	2,2			
2	400	300			
3	400	300			
4	400	300			
5	300	250			
6	200	200			
7	100	100			

LC312_V400_0316_RUNNER_GANCIO_STAB_50



SPX312 + MV600.3E+

100%

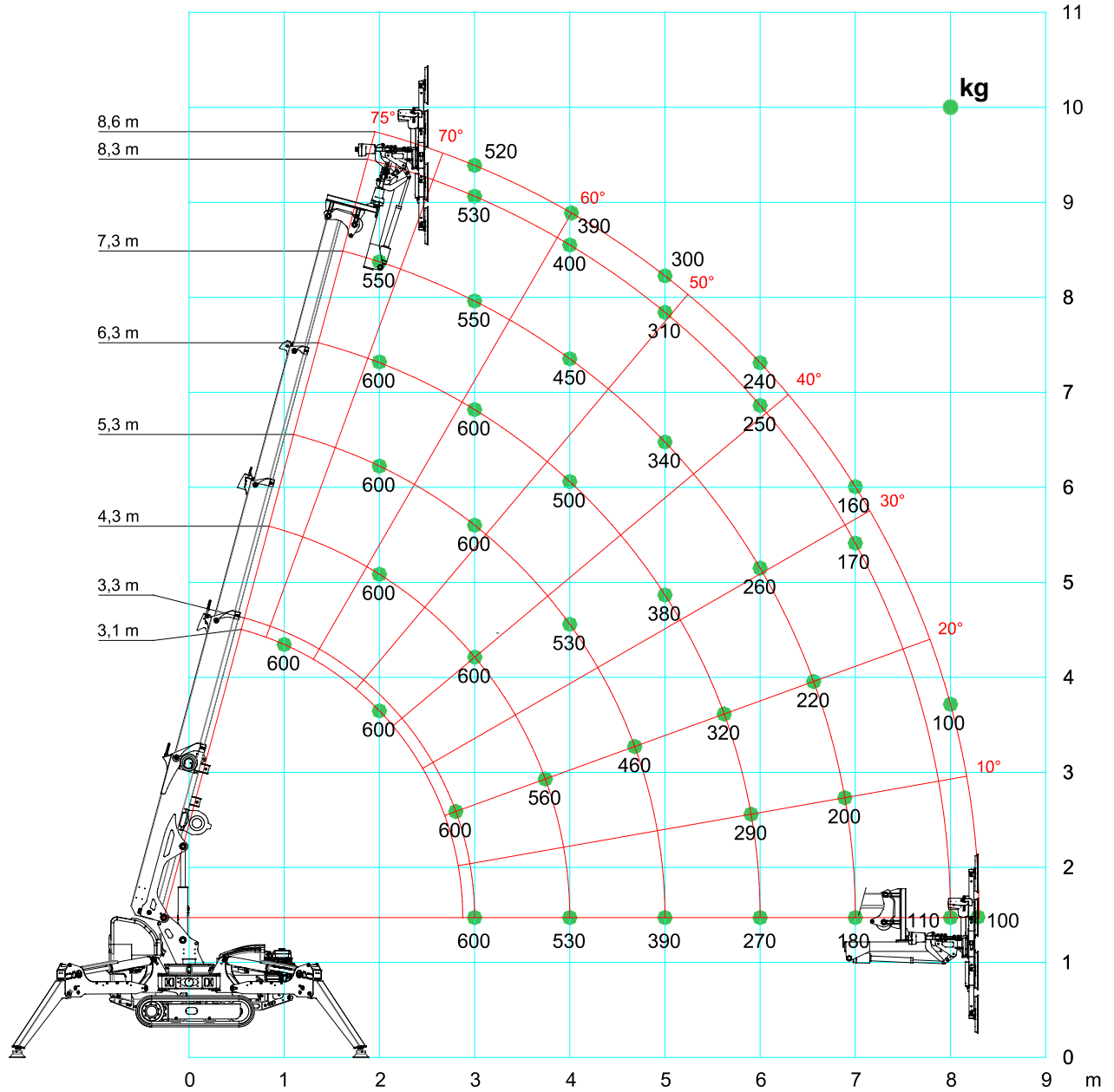

330°

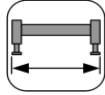
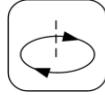
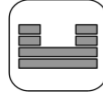
0 kg

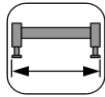
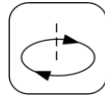
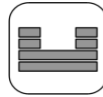

[m] \ [kg]	 MV600.3E+	 100%	 330°	 0kg				
	3,1	3,3	4,3	5,3	6,3	7,3	8,3	8,6
1	600	600	600					
2	600	600	600	600	600	550		
3		600	600	600	600	550	530	520
4			530	530	500	450	400	390
5				390	380	340	310	300
6					270	260	250	240
7						180	170	160
8							110	100
8,3								100

LC312_V400_0316_MANIP_STAB_100

[m] \ [kg]	 MV600.3E+	 50%	 330°	 0kg				
	2,9	3,3	4,3	5,3	6,3	7,3	8,3	8,6
1	600	600	600					
2	600	600	600	600	500	400		
3		600	500	450	420	400	380	360
4			300	280	240	200	180	140
5				150	140	120	100	80

LC312_V400_0316_MANIP_STAB_50

ACCESSORIES

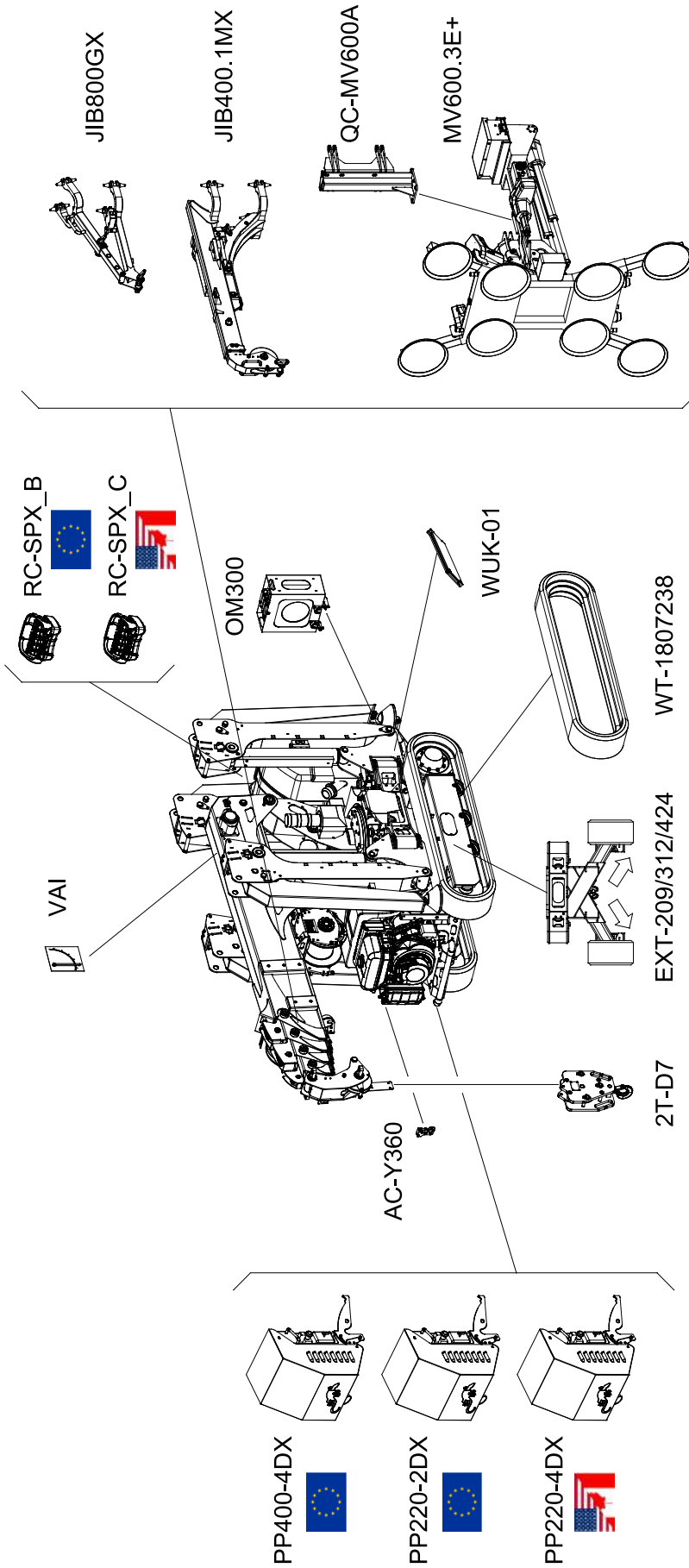

	STD	PC-01	PC-11
Boom, covers and outriggers	RAL2004	RAL____	RAL____
Chassis, frames and tanks	RAL7021	RAL7021	RAL____

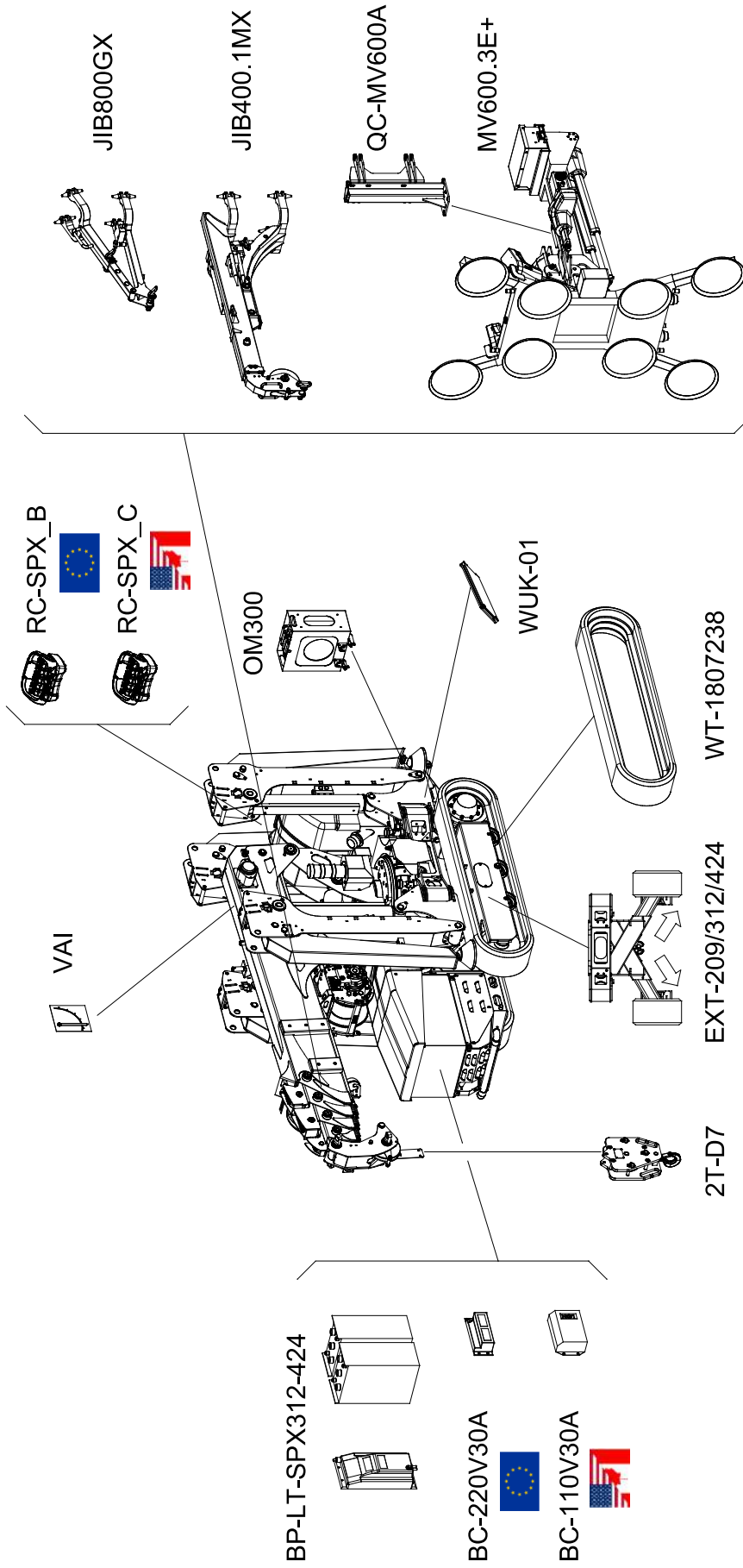

	STD	PC-01	PC-11
Boom, covers and outriggers	RAL2004	RAL____	RAL____
Chassis, frames and tanks	RAL7021	RAL7021	RAL____

ACCESSORIES FEATURES

JIB800GX

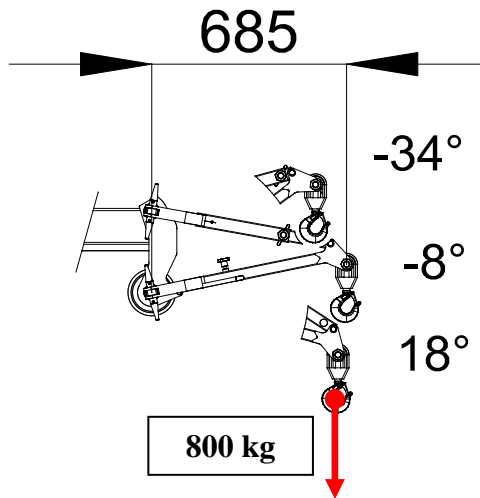

JIB400.1MX

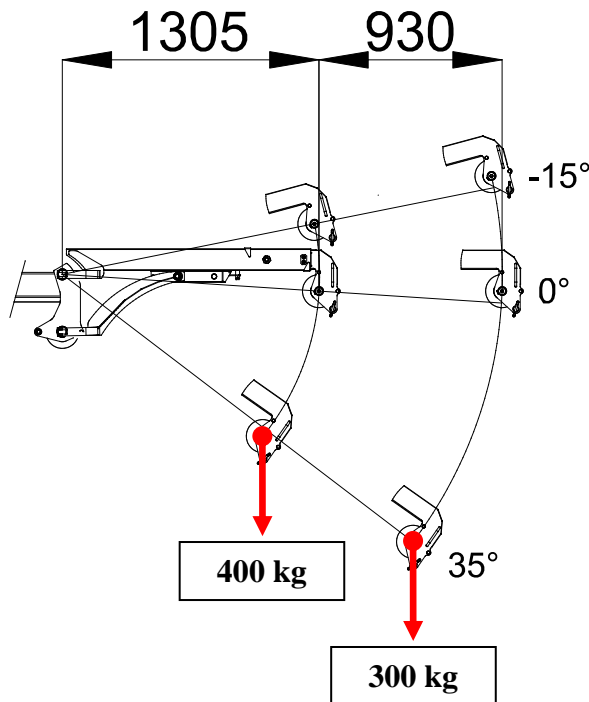

MV600.3E+

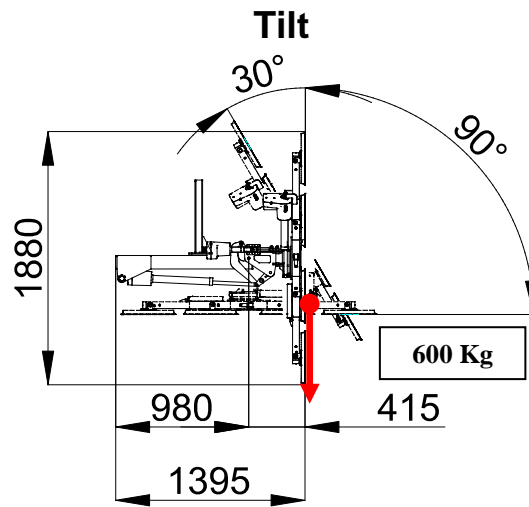

Rotation

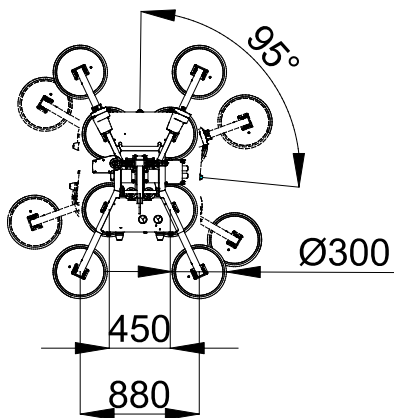

Swing

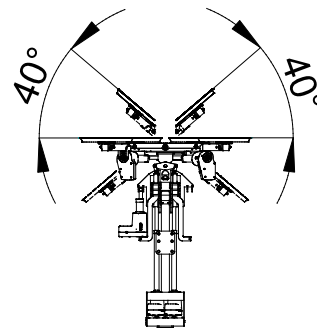

	4	8	n°
	300	600	kg
	150	300	kg

SYMBOLS

	Weight		Chart Wheels		Engine		Jib length and angle
	Counterweight		Minipicker		Diesel Fuel		Jib Length
	Crane		Back Wheel Point Loading		Gasoline Fuel		Jib Radius
	Travel Speed		Front wheel Point Loading		Tank		Hydraulic Jib Length
	Gradeability		Travel Speed		Battery		Hydraulic Jib Radius
	Outrigger Load		Gradeability		Power		Mechanical Jib Length
	Track Loading		Working Radius		Boom Angle		Mechanical Jib Radius
	Outriggers Setup		Hookblock		Boom Length		Manipulator Length
	Ext Tracks Width		Slewing		Boom Radius		Manipulator Radius
	Chart On Tracks		Slewing Locked		Jib Hook Radius		Maximum inclination of the machinery
	Jib on board		Without jib on board		Standard		Stabilizing bar
	Horizontal boom angle		Number of vacuum pads		Factory max. load		Building site max. load
	Powerpack		Outriggers mats		Winter warm-up kit		Hydraulic oil

Remarks referring to load chart

- The load charts are calculated according to EN 13000.
- For the calculation of the load charts at least a wind speed of 9m/s (33km/h) and regarding the load a sail area of 1m² per ton load and a wind resistance coefficient of 1.2 on the load have been taken into account. For lifting of loads with large sail areas and/or high wind resistance coefficients the maximum wind speed as stated in the load charts has to be reduced.
- Lifting capacities are given in kilograms.
- The weight of the hook blocks and hooks is part of the load and therefore it must be deducted from the lifting capacities.
- Working radii are measured from the slewing centre.
- The lifting capacities given for the telescopic boom apply if the folding jib is removed.
- Subject to modification of lifting capacities.



NOTES

A large, empty rectangular box with a thin black border, intended for taking notes.



DEALER



JEKKO S.r.l. via Campardone, 1 Z.I. 31014 Colle Umberto (TV) Italy
tel. +39 0438 1710083 fax +39 0438 1710123
www.jekko.it - info@jekko.it