

# Hanwell Pro

## Sensor Options

The **Hanwell Pro** Sensor options technical data sheet details all the sensors available to use with the Hanwell Pro Series products.

Please select your product first from the relevant Hanwell Pro product datasheets, then add your required sensor appropriately as below. *Please note that sensor temperature ranges may be restricted by the instrument it is used with. Please check the relevant instrument data sheet.*

Note - This datasheet covers our standard and readily available cable lengths. Other lengths maybe available than those listed. Please contact Hanwell Solutions with your requirements.



Temperature



Humidity



Carbon Dioxide



Flood



Airflow



Manufactured by Ellab Monitoring Solutions



RoHS



Version 12 - EC210140

**Disclaimer:** The information contained herein is believed to be reliable. Ellab Monitoring Solutions Ltd is not responsible for any incorrect or incomplete information on this datasheet and the information or product maybe changed without notice. Customers should obtain and verify the latest relevant information before placing orders for Hanwell products.

[ellab.com](http://ellab.com)

Tel: +44 (0)1462 688070 | Email: [sales.hanwell@ellab.com](mailto:sales.hanwell@ellab.com)

		Probe Family																			
Product family	Unit Type	Thermistor				PT100		PT1000	Thermocouple		Door	Flood*	RHT			CO <sub>2</sub>		Y060**	Airflow		
		Y300	J095	J254	Y306	J094	J237	J182	J043	J044	Door	V053	J140/ J223	J115	J279	J247	J256-07	Analogue	J202 (0-5ms)	J189 (0-10ms)	J211 (0-20ms)
4001	Single Thermistor	✓	✓	✓	✓																
4002	Dual Thermistor	✓	✓	✓	✓																
4107	RHT + Flood										✓										
4108	RHT + Surface temp				✓																
4012	Thermistor + Door	✓	✓	✓	✓					✓											
4021	Temperature and CO <sub>2</sub>					✓	✓								✓						
4111	RHT (High Accuracy)												✓	✓							
4114	RHT											✓									
4115	RHT	✓	✓	✓	✓							✓									
4116	RHT + T	✓	✓	✓	✓							✓									
4401	Single PT100					✓	✓														
4402	Dual PT100					✓	✓														
4410	PT100 + Door					✓	✓			✓											
4406	PT1000 + Door							✓		✓											
4512	CO <sub>2</sub> + Thermistor	✓	✓	✓	✓										✓						
4805	Single Flood										✓										
4809	Dual 4-20mA															✓	✓				
4810	Single 0-5volt																✓	✓	✓	✓	✓
4901	Single T'couple (-200 to 200)								✓												
4902	Single T'couple (-200 to 200) + door								✓	✓											
4903	Single T'couple (-50 to +350)									✓											
4904	Single T'couple (-50 to +350) + door									✓	✓										

\*Sold by the metre

\*\*Supplied with instrument

# Thermistor Probes

Y300	Part codes	Specifications
25mm Probe	<b>Y300</b>	Probe diameter 4mm
80mm probe	<b>Y300-80</b>	Probe operating range -40°C to +125°C
		Accuracy +/- 0.1°C between -10°C to +40°C +/- 0.3°C outside these extremes
		Long term drift < 0.1°C per year
		Optional Extension Cables Y004 (1 metre) Y004-2 (2metre) Y004-3 (3 metre)
		Temperature Operating range -200°C to +250°C

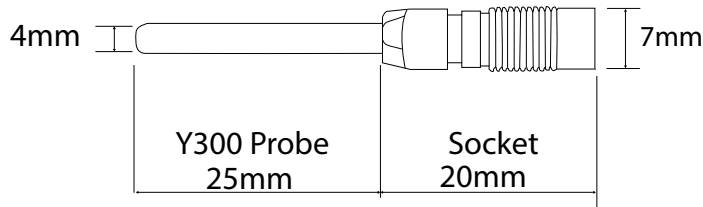

J095	Part codes	Specifications
<b>Non-waterproof</b>		Probe diameter 4mm
3 metre cable	<b>J095-3-05</b>	Probe operating range -40°C to +125°C
5 metre cable	<b>J095-5-05</b>	Accuracy +/- 0.1°C between -10°C to +40°C +/- 0.3°C outside these extremes
<b>Waterproof</b>		Long term drift < 0.1°C per year
3 metre cable	<b>J095-3-05-WP</b>	IP rating IP68 (Waterproof version only)
5 metre cable	<b>J095-5-05-WP</b>	

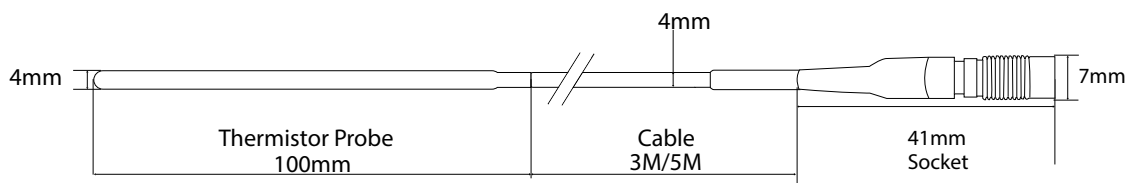

Manufactured by Ellab Monitoring Solutions

Version 12 - EC210140

**Disclaimer:** The information contained herein is believed to be reliable. Ellab Monitoring Solutions Ltd is not responsible for any incorrect or incomplete information on this datasheet and the information or product may be changed without notice. Customers should obtain and verify the latest relevant information before placing orders for Hanwell products.

[ellab.com](http://ellab.com)

Tel: +44 (0)1462 688070 | Email: [sales.hanwell@ellab.com](mailto:sales.hanwell@ellab.com)

# Thermistor Probes cont'd

J254	Part codes	Specifications
<b>Non-waterproof</b>		Probe diameter 3mm
3 metre cable	<a href="#">J254-3-05</a>	Probe operating range -40°C to +125°C
<b>Waterproof</b>		Accuracy +/- 0.1°C between -10°C to +40°C +/- 0.3°C outside these extremes
3 metre cable	<a href="#">J254-3-05-WP</a>	Long term drift < 0.1°C per year
		IP rating IP68 (Waterproof version only)

(Thin probe and cable for easy routing around fridge/freezer door seals)

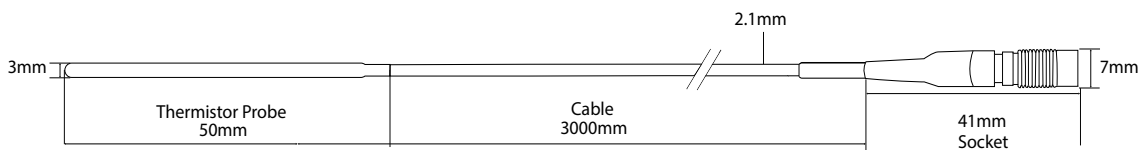

Y306	Part codes	Specifications
3 metre cable	<a href="#">Y306-3-05</a>	Tag diameter 12mm
5 metre cable	<a href="#">Y306-5-05</a>	Probe operating range 0°C to +125°C
		Accuracy +/- 0.1°C between -10°C to +40°C +/- 0.3°C outside these extremes
		Long term drift < 0.1°C per year

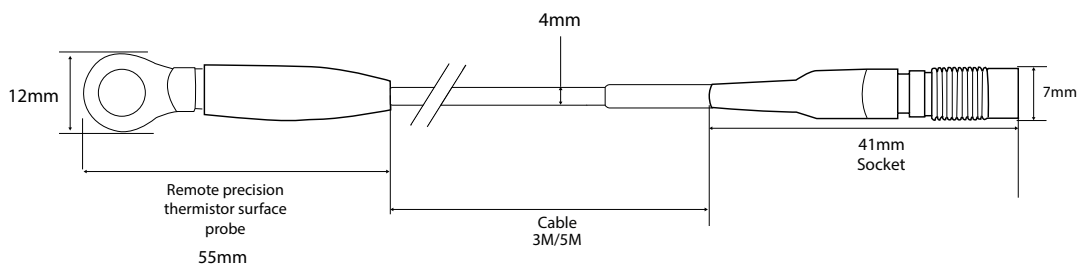

# PT100 Probes

J094	Part codes	Specifications
<b>Non-waterproof</b>		Type: Flat film
3 metre cable	<a href="#">J094-3-01</a>	Probe diameter: 4mm
5 metre cable	<a href="#">J094-5-01</a>	Probe operating range: -90°C to +250°C
<b>Waterproof</b>		Accuracy -50°C to +250°C: +/- (0.15+0.002* t )°C
3 metre cable	<a href="#">J094-3-01-WP</a>	Accuracy Below -50°C: +/- (0.3+0.005* t )°C
5 metre cable	<a href="#">J094-5-01-WP</a>	Long term drift: +/- 0.1°C per year* *dependent on conditions of use
		IP Rating: IP68 (Waterproof version only)

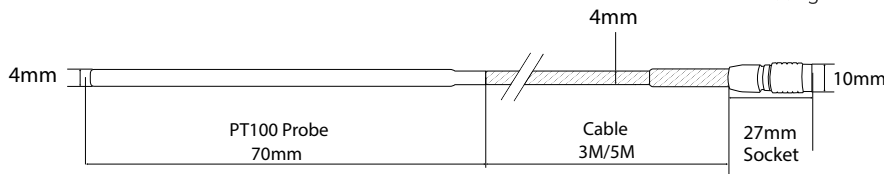

J237	Part codes	Specifications
<b>Non-waterproof</b>		Type: Wire wound
3 metre cable	<a href="#">J237-3-01</a>	Probe diameter: 4mm
5 metre cable	<a href="#">J237-5-01</a>	Probe operating range: -200°C to +250°C
<b>Waterproof</b>		Accuracy -100°C to +250°C: +/- (0.15+0.002* t )°C
3 metre cable	<a href="#">J237-3-01-WP</a>	Accuracy Below -100°C: +/- (0.3+0.005* t )°C
5 metre cable	<a href="#">J237-5-01-WP</a>	Long term drift: +/- 0.05°C per year* *dependent on conditions of use
		IP Rating: IP68 (Waterproof version only)

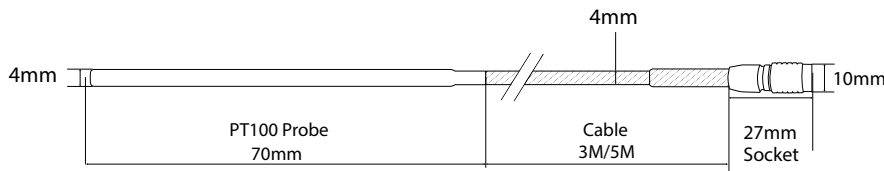

Extension cables (suitable for J094 and J237)	Part codes	Specifications
1 metre cable	<a href="#">Y509</a>	Temperature Operating range: -200°C to +250°C
3 metre cable	<a href="#">Y509-3</a>	
5 metre cable	<a href="#">Y509-5</a>	
10 metre cable	<a href="#">Y509-10</a>	
15 metre cable	<a href="#">Y509-15</a>	

# J043/J044 Thermocouple Probes

Teflon Coated	Part codes	Specifications
3 metre cable	<a href="#">J043-3-09</a>	Type Ultra precision Teflon coated Type T (Thermocouple junction is isolated)
5 metre cable	<a href="#">J043-5-09</a>	Probe diameter 3mm
		Probe operating range -200°C to +200°C
		Accuracy BS EN 60584 - 1:2013 Class 1 +/- 0.5°C or +/-0.4%, (whichever is greater) above -40°C
		Below -40°C +/-1 or 1.5% of reading
		Long term drift < 0.1°C per year

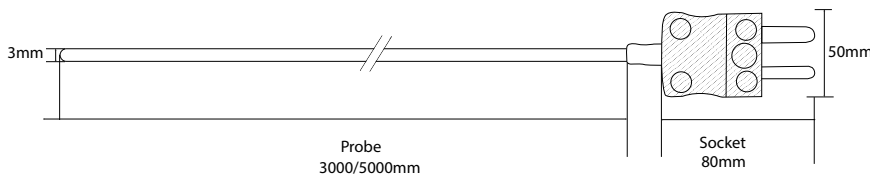

Mineral Insulated	Part codes	Specifications
3 metre cable	<a href="#">J044-3-09</a>	Type Mineral insulated Type T (Thermocouple junction is isolated)
5 metre cable	<a href="#">J044-5-09</a>	Probe diameter 3mm
		Probe operating range -200°C to +350°C
		Accuracy BS EN 60584 - 1:2013 Class 1 +/- 0.5°C or +/-0.4%, (whichever is greater) above -40°C
		Below -40°C +/-1 or 1.5% of reading
		Long term drift < 0.1°C per year

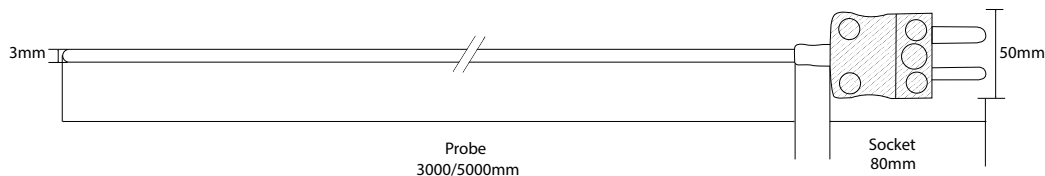

# RH/T Probes

J140	Part codes	Specifications
	J140	

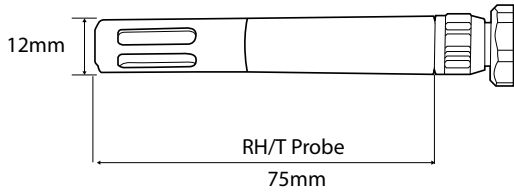

Temperature accuracy chart for J140 probe

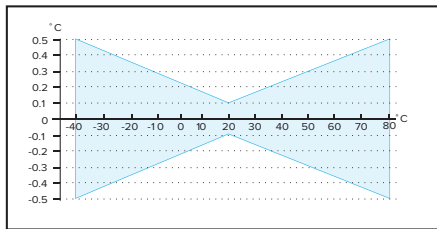

J223	Part codes	Specifications
	J223	

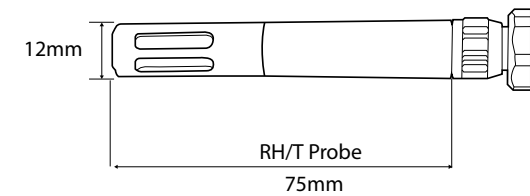

Temperature accuracy chart for J223 probe

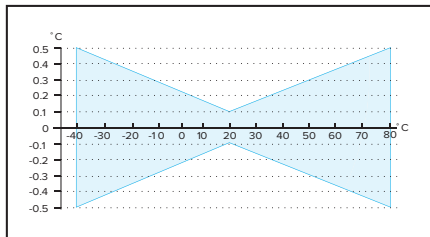

Extension cables for J140/J223	Part codes	Specifications
1 metre cable	Y421-1	Temperature Operating range -25°C to +85°C
3 metre cable	Y421-3	

# RH/T Probes cont'd

J115	Part codes	Specifications
	<b>J115</b>	
		<b>Humidity Probe details</b> Recommended range 0-100% RH non condensing Accuracy +/- 0.8%RH/ +/- 0.1°C at 10°C to +30°C Long term stability <1% per annum <b>Temperature Probe details</b> Temperature operating range -50°C to +100°C Temperature accuracy PT100 1/3 DIN Class B (see temp accuracy chart)

Extension cables	Part codes	Specifications
2 metre cable	<b>Y527</b>	Temperature Operating range -50°C to +100°C
5 metre	<b>Y528</b>	

Temperature window graph for J115 probe

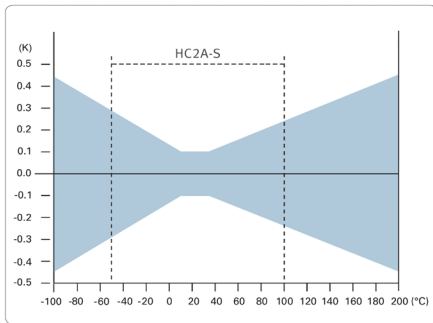

Humidity graph for J115 probe

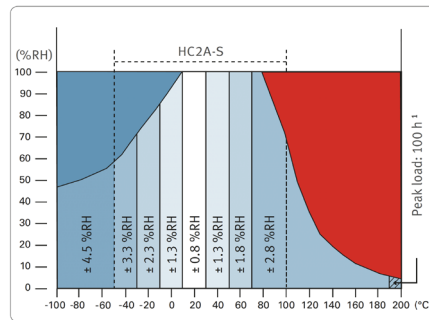

J279	Part codes	Specifications
	<b>J279</b>	
		<b>Description</b> Measures Relative Humidity and Temperature in a Hydrogen Peroxide environment. <b>Humidity Probe details</b> Recommended range 0-100% RH non condensing Accuracy +/- 0.8%RH/ +/- 0.1K at 10°C to +30°C <b>Temperature Probe details</b> Temperature Sensor PT100 1/3 Class B Temperature Probe operating range 0°C to +60°C Temperature Probe accuracy +/- 0.1°C at 10°C to +30°C (see temp accuracy chart)
<p>Temperature window graph for J279 probe</p>		<p><b>Note:</b> When used with the RL4111-DU-xxx.xxx transmitter, both the transmitter and probe can be located within the Hydrogen Peroxide environment. When used with the RL4111-xxx.xxx transmitter, the transmitter must be mounted in a Hydrogen Peroxide free environment and the probe mounted remotely, via an extension cable.</p>

Extension cables	Part codes	Specifications
2 metre cable	<b>Y527</b>	Cable Temperature Operating Range -50°C to +100°C
5 metre	<b>Y528</b>	



# External CO<sub>2</sub> Sensor

J247	Part codes	Specifications
(0-5% CO <sub>2</sub> )	<a href="#">J247-5-02</a>	Operating Temperature of CO <sub>2</sub> Measurement -40°C to +60°C
(0-10% CO <sub>2</sub> )	<a href="#">J247-10-02</a>	Accuracy @ 25°C and 1013 PA ±0.1% CO <sub>2</sub>
		Temperature Dependence with Compensation, 0 to 20%CO <sub>2</sub> between -40°C and +60°C ±0.045% of reading/°C
		Long term drift +/- 0.3% CO <sub>2</sub> per year
		Housing PET plastic
		Cable 1.5 metre*
		Output 0-5VDC

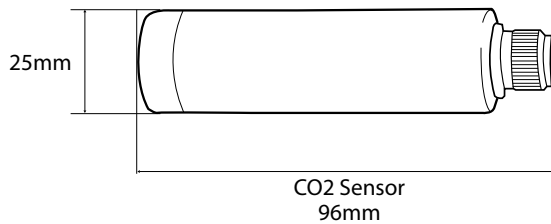

*Recommended Installation: The probe can be installed in an environment with an operating temperature range -40 °C to +60 °C. Make sure the probe is in a location that represents the measurement environment properly.*

\*Spare cable available with part no. J247-CAB

# CO<sub>2</sub> Concentration Sensor

J256-07	Part codes	Specifications
	<a href="#">J256-07</a>	Operating Temperature of CO <sub>2</sub> Measurement -30°C to +60°C
		Measuring range 0 to 2000ppm
		Accuracy ±50ppm +2% of measured value
		Temperature Dependence -20°C to +45°C typ. 2ppm CO <sub>2</sub> / °C
		Analog output 4-20mA
		IP Rating of housing IP30
		Cable 3 metre

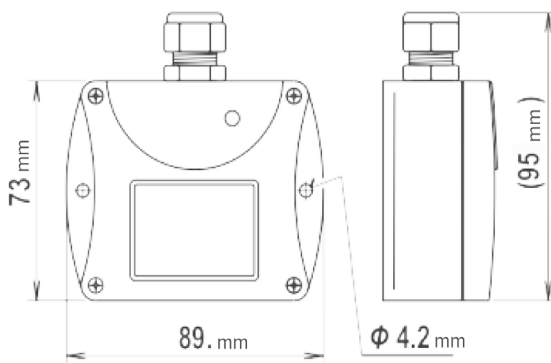

# Airflow Sensors

0-5M/S	Part codes	Specifications
	<b>J202-07</b>	
		Probe operating range 0-5m/s (0... 1000ft/min)
		Analogue Output 0-5V
		Working range temperature -20°C to +60°C
		Storage temperature -30°C to +60°C
		Working range 0-5m/s (0... 1000ft/min)
		Accuracy ±(0.2m/s / 40ft/ min +3% of measuring value)
		Cable length 2 metres
		Power Supply 12V via external universal power supply

0-10M/S	Part codes	Specifications
	<b>J189-07</b>	
		Probe operating range 0-10m/s (0...2000ft/min)
		Analogue Output 0-5V
		Working range temperature -20°C to +60°C
		Storage temperature -30°C to +60°C
		Working range 0-10m/s (0...2000ft/min)
		Accuracy ±(0.3m/s / 60ft/ min +4% of measuring value)
		Cable length 2 metres
		Power Supply 12V via external universal power supply

0-20M/S	Part codes	Specifications
	<b>J211-07</b>	
		Probe operating range 0-20m/s (0...4000ft/min)
		Analogue Output 0-5V
		Working range temperature -20°C to +60°C
		Storage temperature -30°C to +60°C
		Working range 0-20m/s (0...4000ft/min)
		Accuracy ±(0.4m/s / 80ft/min +6% of measuring value)
		Cable length 2 metres

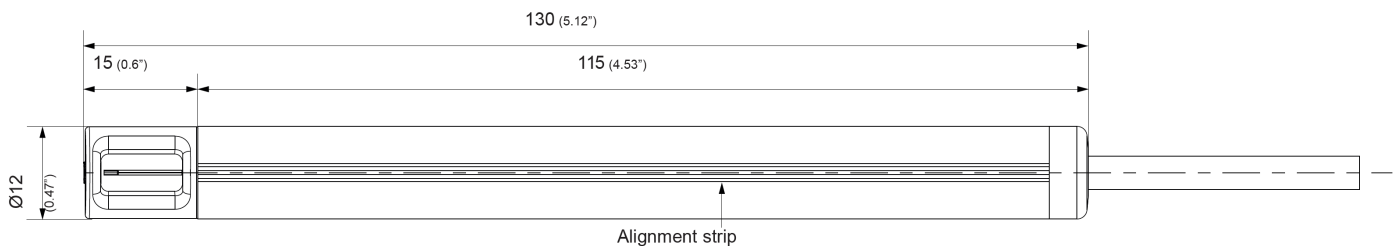

Manufactured by Ellab Monitoring Solutions



RoHS



Version 12 - EC210140

**Disclaimer:** The information contained herein is believed to be reliable. Ellab Monitoring Solutions Ltd is not responsible for any incorrect or incomplete information on this datasheet and the information or product may be changed without notice. Customers should obtain and verify the latest relevant information before placing orders for Hanwell products.

[ellab.com](http://ellab.com)

Tel: +44 (0)1462 688070 | Email: [sales.hanwell@ellab.com](mailto:sales.hanwell@ellab.com)

# PT1000 Probes

J182	Part codes	Specifications
<b>Non-waterproof</b>		Probe diameter 4mm
3 metre cable	<a href="#">J182-3-01</a>	Probe operating range -90°C to +110°C
5 metre cable	<a href="#">J182-5-01</a>	Accuracy Class A = +/- (0.15+0.0020* t )°C
<b>Waterproof</b>		Long term drift +/- 0.05 °C per year
3 metre cable	<a href="#">J182-3-01-WP</a>	IP Rating IP68 (Waterproof version only)
5 metre cable	<a href="#">J182-5-01-WP</a>	

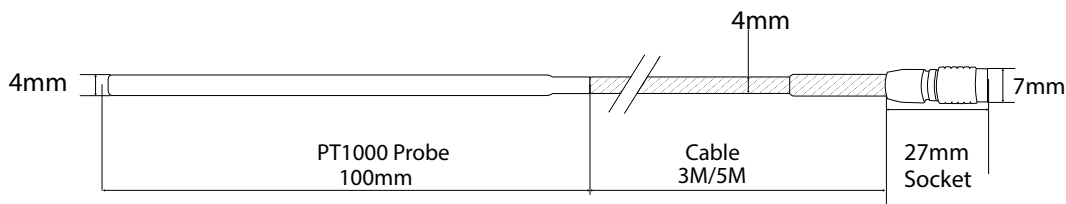

# Door Sensors

DC001	Part codes	Specifications
3 metre cable	<a href="#">DC001</a>	Cable length 3 metre cable

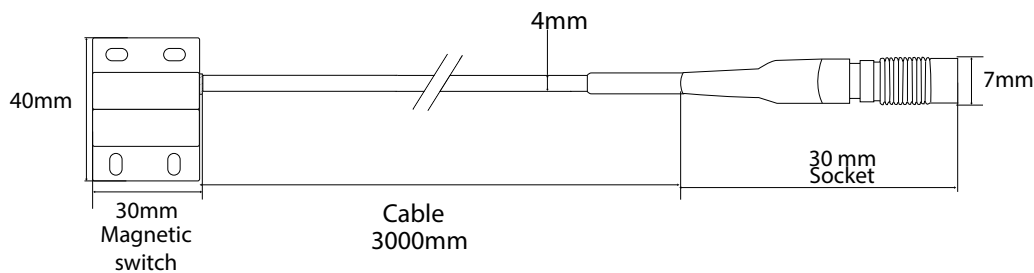

Manufactured by Ellab Monitoring Solutions



RoHS



Version 12 - EC210140

**Disclaimer:** The information contained herein is believed to be reliable. Ellab Monitoring Solutions Ltd is not responsible for any incorrect or incomplete information on this datasheet and the information or product may be changed without notice. Customers should obtain and verify the latest relevant information before placing orders for Hanwell products.

[ellab.com](http://ellab.com)

Tel: +44 (0)1462 688070 | Email: [sales.hanwell@ellab.com](mailto:sales.hanwell@ellab.com)

# Door Sensors cont'd

DC002 (Medium duty Door switch with Lemo)	Part codes	Specifications
	<b>DC002</b>	Cable length 3 metre cable

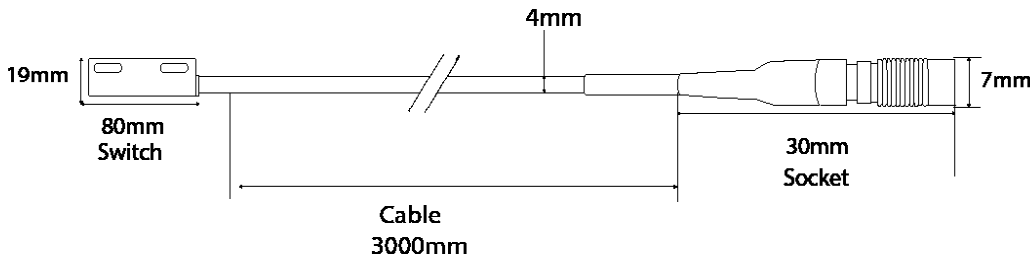

DC003 (Industrial Door events sensor)	Part codes	Specifications
	<b>DC003</b>	Cable length 3 metre cable

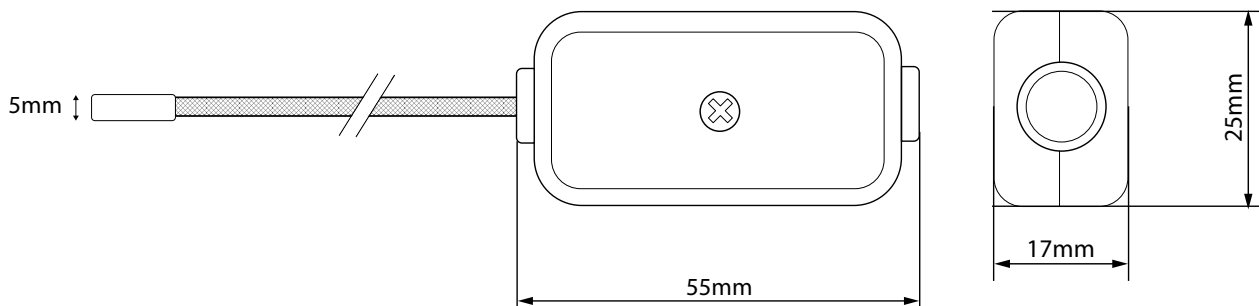
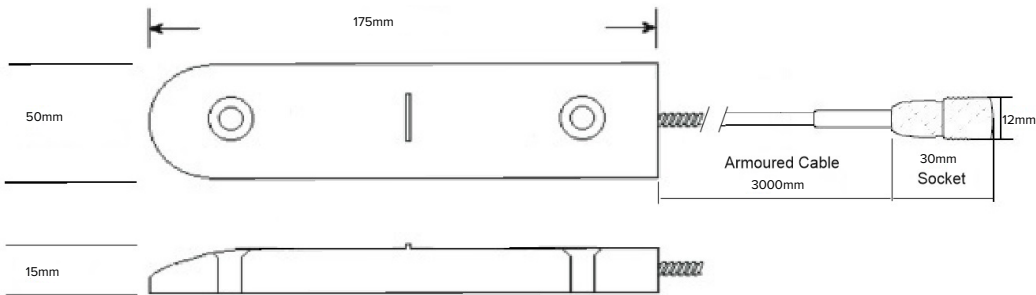

Manufactured by Ellab Monitoring Solutions

Version 12 - EC210140

**Disclaimer:** The information contained herein is believed to be reliable. Ellab Monitoring Solutions Ltd is not responsible for any incorrect or incomplete information on this datasheet and the information or product may be changed without notice. Customers should obtain and verify the latest relevant information before placing orders for Hanwell products.

[ellab.com](http://ellab.com)

Tel: +44 (0)1462 688070 | Email: [sales.hanwell@ellab.com](mailto:sales.hanwell@ellab.com)