

Rideau d'air chaud

ProtectoR



KAMPMAN
Genau mein Klima.



Avantages imbattables



ProtecTor en un coup d'œil



Détails

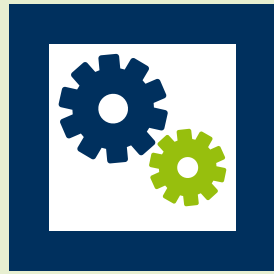

Variantes de réglages

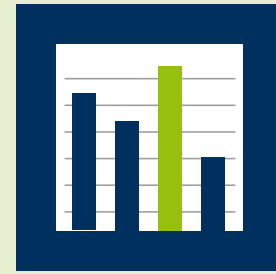

Performances

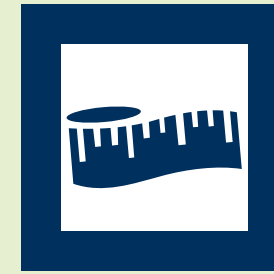

Dimensions



Vos avantages!





ProtecTor:
une protection contre l'air froid dans des espaces aux portes ouvertes



Gain de place au niveau des portes

Profitez, même avec des portes ouvertes, d'un gain de place grâce à une meilleure utilisation de l'espace et ce, également à proximité des portes.

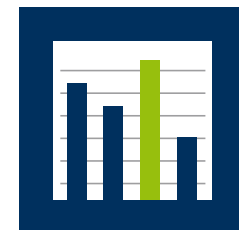

Protection invisible

Le jet primaire non tempéré et le rideau d'air chaud du ProtecTor sont installés parallèlement. C'est la raison pour laquelle un seul ventilateur suffit pour protéger efficacement contre l'air froid. Le hall est ainsi à l'abri des courants d'air et l'air y reste chaud. Un brevet a par ailleurs été déposé pour cette technique.

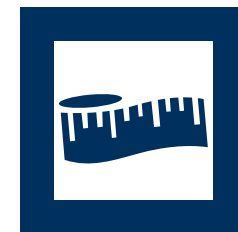
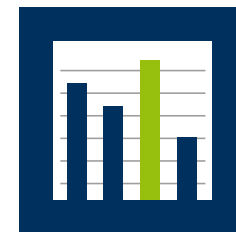

Double action pour plus d'économies

L'interaction du jet primaire et du rideau d'air chaud permet de réaliser des économies d'énergie pouvant aller jusqu'à 38 % par rapport aux systèmes traditionnels. Vous pouvez ainsi amortir plus rapidement votre nouveau système de protection de porte Kampmann.

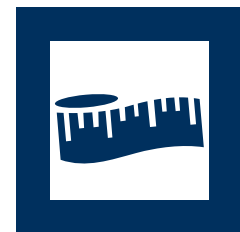
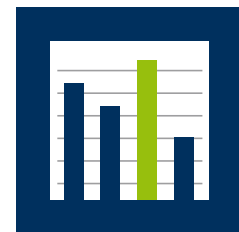

L'embarras du choix

Vous pouvez opter pour un modèle horizontal ou vertical, mais aussi pour différents échangeurs thermiques. Il vous suffit ensuite de choisir la dimension adéquate, et le ProtecTor idéal est à vous.

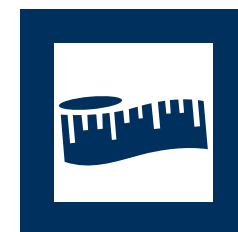
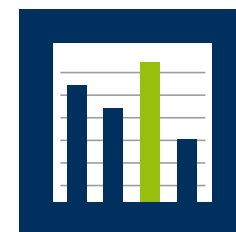

Réglage parfait

Le réglage se fait en toute simplicité à l'aide du commutateur à vitesses et du commutateur de contact de porte ou grâce à notre système d'automatisation de pièce KaControl. Nous restons bien entendu à votre disposition pour toute demande particulière!

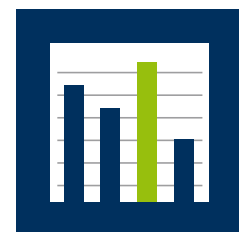

Livraison rapide

Des délais de livraison courts pour de la flexibilité et de la rapidité: les ProtecTor de base sont sur votre chantier sept jours à peine après l'examen technique. Faites-nous confiance, et vos clients vous feront confiance à leur tour.

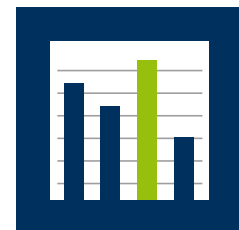



- ① Avance (2")
- ② Retour (2")
- ③ Échangeur thermique PowerKon
- ④ L'air est aspiré
- ⑤ Buse de sortie (par exemple: sortie centrale)
- ⑥ Ventilateur axial silencieux à hélice
- ⑦ Jet primaire
- ⑧ Rideau d'air chaud

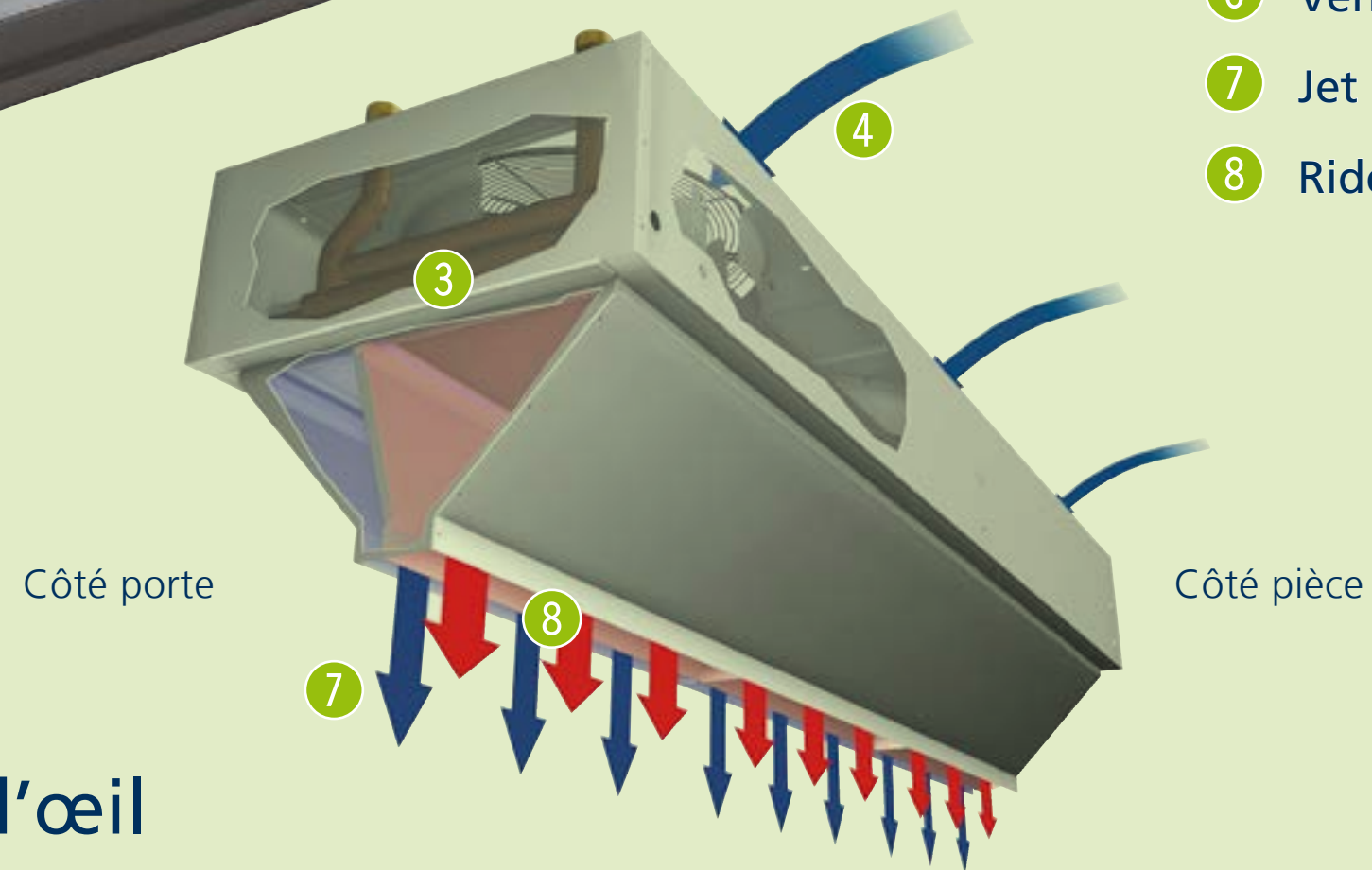

Le ProtecTor en un coup d'œil



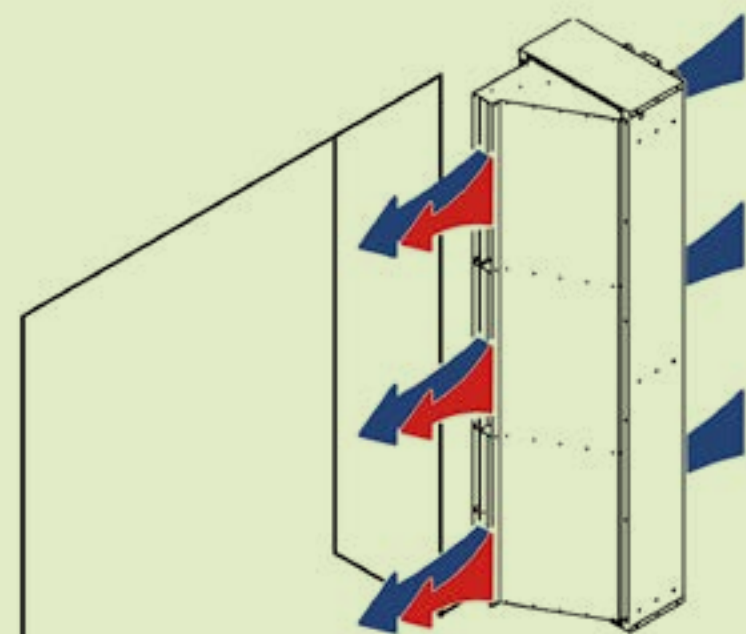

Exemple: vertical droit;
avec buse de sortie, sortie unilatérale

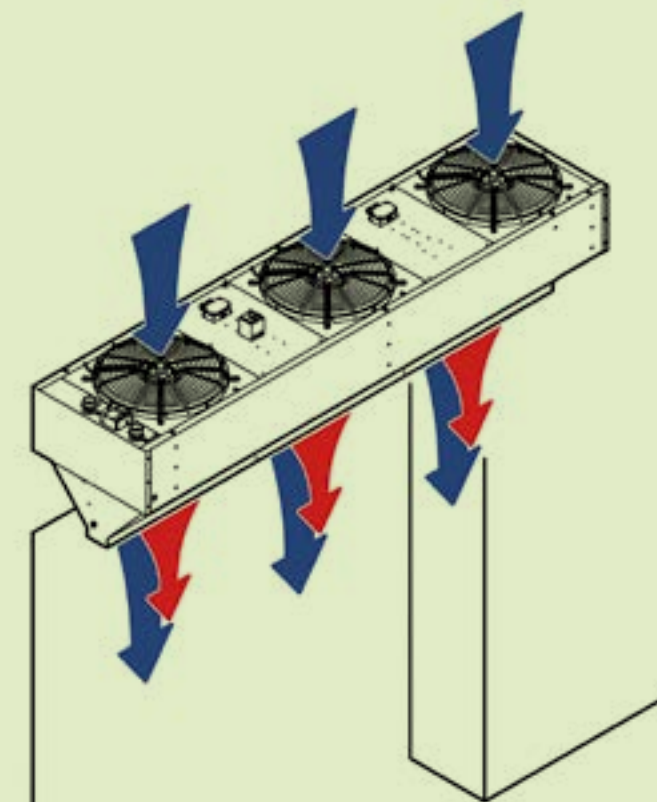

Exemple: avec buse de sortie,
sortie centrale

Modèle vertical

- ▶ Guidage horizontal de l'air devant la porte (côté pièce)
- ▶ Modèle vertical disponible à gauche ou à droite. Disposition également possible des deux côtés en cas de portes surdimensionnées.

Modèle horizontal

- ▶ Guidage de l'air de haut en bas

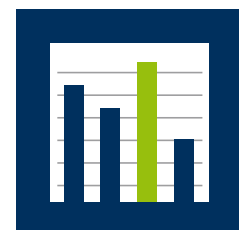
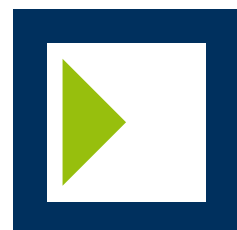

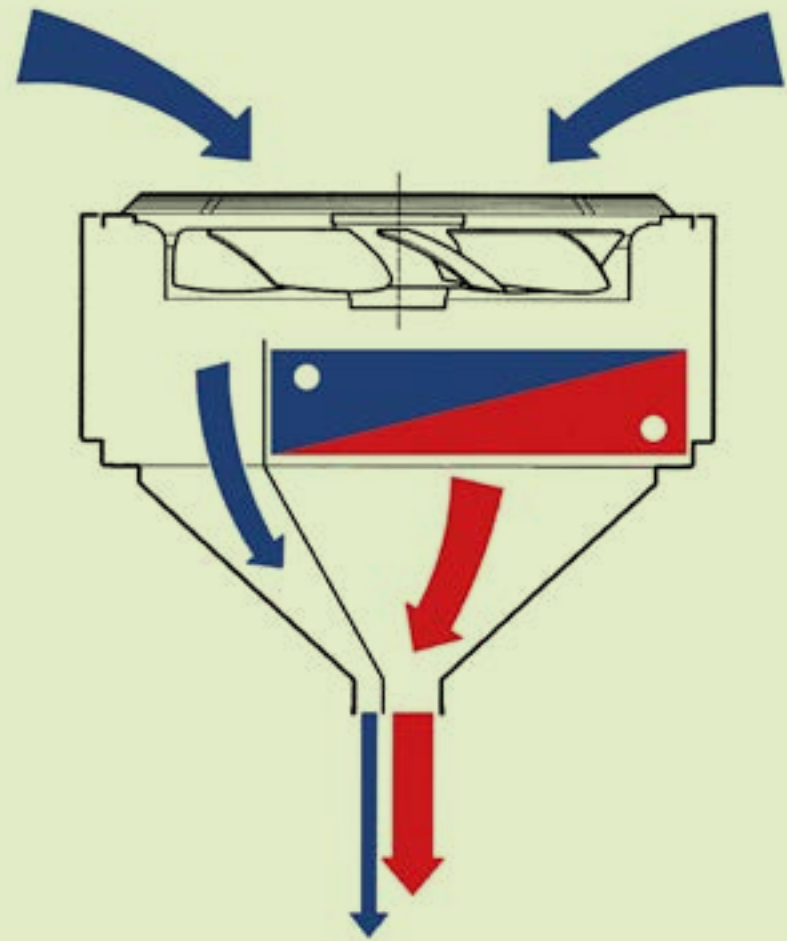

Effet de couche limite de tourbillon

- ▶ Augmentation de la profondeur de pénétration pour les deux jets d'air: le jet primaire tire le rideau d'air chaud vers le bas
- ▶ Le jet primaire a une fonction protectrice: il est automatiquement optimisé en cas de modification de la vitesse de rotation des ventilateurs et s'adapte au jet d'air chaud



Ventilateur axial silencieux à hélice

- ▶ Courant triphasé à deux niveaux, 400 V/50 Hz

Échangeur thermique PowerKon

- ▶ Tuyaux ronds en cuivre avec lamelles spéciales profilées en aluminium
- ▶ En option: modèle en acier galvanisé

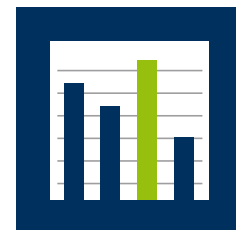
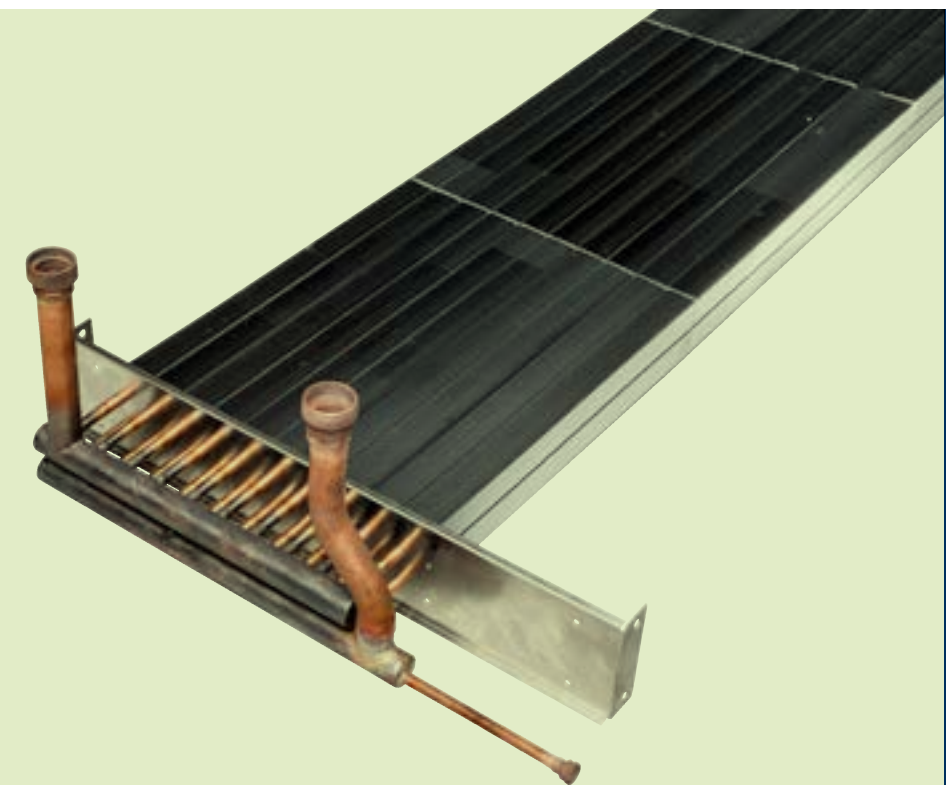

Variantes de réglage



Automatisation de pièce KaControl

- ▶ Technologie KaControl intégrée de série pour la construction d'un réseau de systèmes d'ensemble à connecter au KaControl
- ▶ Interface pour BACnet* ou automatisation de bâtiment Modbus comme modules enfichables en option
- ▶ Entrée analogique 0–10V pour le pilotage du ventilateur et de la vanne via un point de données unique
- ▶ Commande de pièce design avec guidage intuitif
- ▶ Programme de commutation horaire intégré

* *Serveur Web intégré*



Moteur à courant triphasé à 5 niveaux

- ▶ avec raccord pour thermostat d'ambiance
- ▶ avec minuterie ou commutateur de contact de porte

Rendez-vous sur Kampmann.fr pour davantage de thermostats horaires et d'ambiance ; modèles particuliers disponibles sur demande

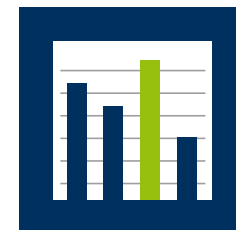

KAMPDMANN
Genau mein Klima.

Performances

ProtecTor | Modèles horizontaux ou verticaux

Dimensions des ventilateurs	A	B	Hauteur et profondeur	Hauteur et portée de soufflage max.	Largeur et hauteur de porte max.	Nombre de ventilateurs	Vitesse de commutation des ventilateurs	Flux d'air total ¹⁾	Puissance calorifique ²⁾	Niveau de pression acoustique ³⁾
	[mm]	[mm]	[mm]	[m]	[m]			[m³/h]	[kW]	[dB(A)]
6	740	3000	360	3,50	3,25	3	2	13.900	65,0	62,5
		1					11.000	50,0	55,5	
		4000			4,25	4	2	18.500	86,7	64,0
							1	14.700	66,6	57,0
		5000			5,25	5	2	23.200	108,3	65,0
							1	18.300	83,3	58,0
7	840	3000	360	4,50	3,25	3	2	21.500	100,3	65,5
		1					17.900	79,5	61,5	
		4000			4,25	4	2	28.600	133,8	67,0
							1	23.900	106,0	63,0
		5000			5,25	5	2	35.800	167,2	68,0
							1	29.800	132,5	64,0

¹⁾ Somme du jet primaire et du rideau d'air chaud

²⁾ En cas de PWW 75/65 °C, $t_{L1} = 20$ °C

³⁾ À 5 m d'écart



Dimensions

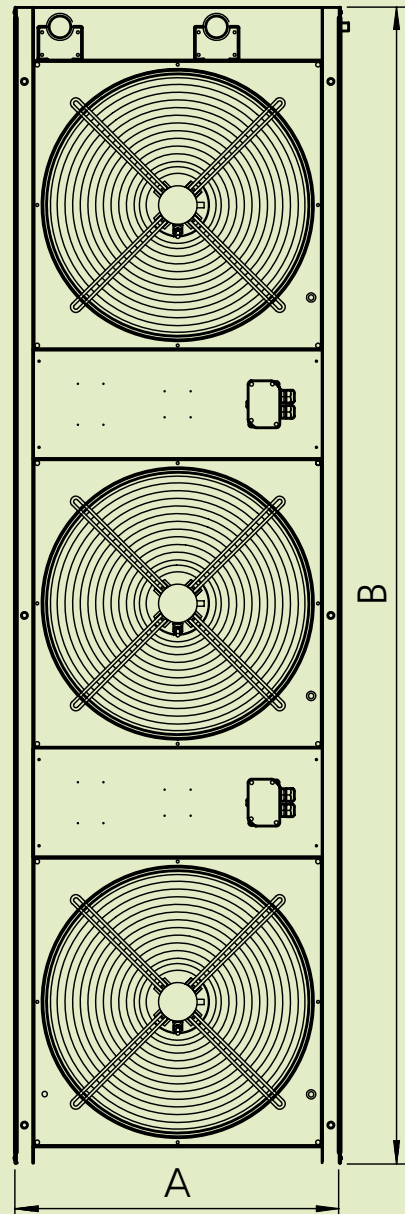

Modèle vertical

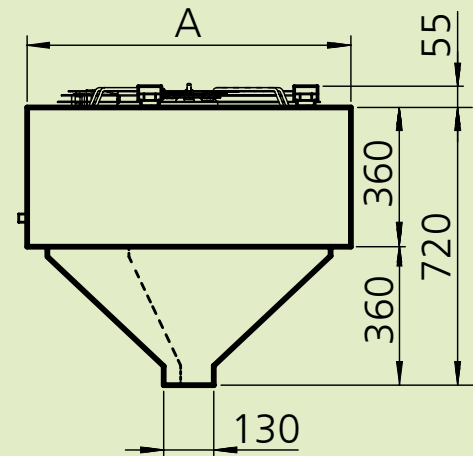

Sortie centrale

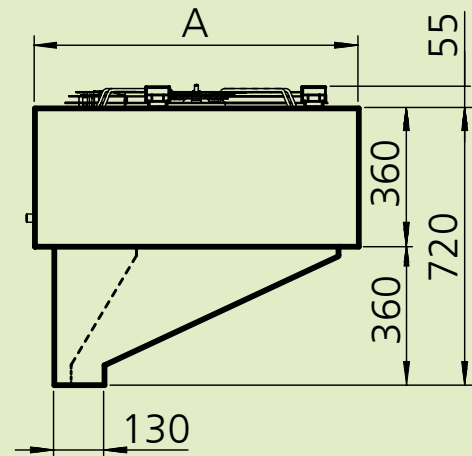

Sortie unilatérale

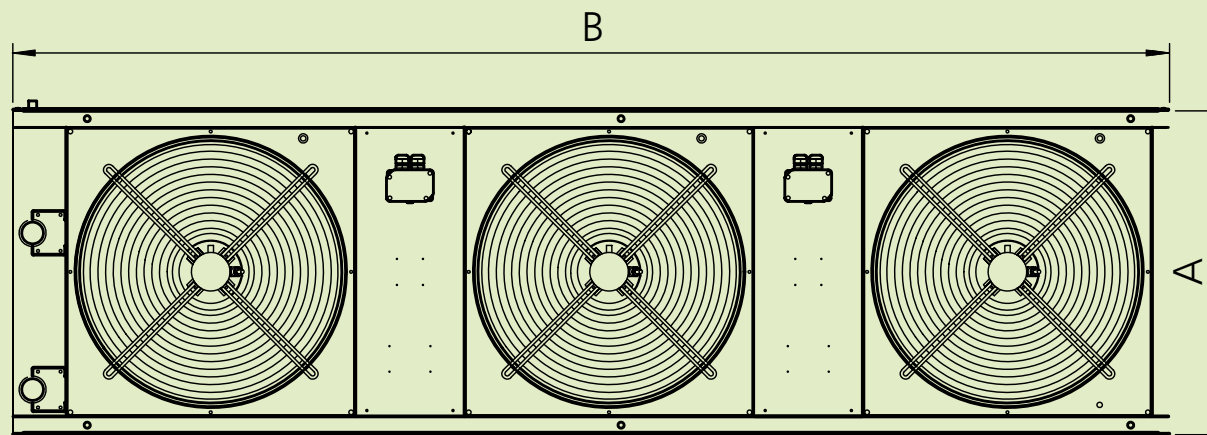

Modèle horizontal

Dimensions des ventilateurs	A	B
	[mm]	[mm]
6	740	3000
		4000
		5000
7	840	3000
		4000
		5000



Vos avantages!

Kampmann vous offre les avantages de service suivants:

- ▶ conseils sur place
- ▶ aide à la planification pour tous les articles
- ▶ solutions système
- ▶ discussion des détails
- ▶ service après-vente

Ici, nous sommes à votre service:

Kampmann.fr/contact

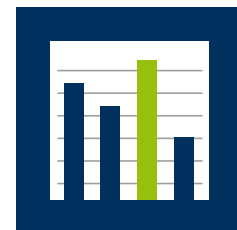

Kampmann.fr

Kampmann GmbH
Friedrich-Ebert-Str. 128–130
49811 Lingen (Ems)
Allemagne

T +49 591 7108-0
F +49 591 7108-300
E info@kampmann.de
W Kampmann.de

Représentation BeNeLux-France
Godsheidestraat 1
3600 Genk
Belgique

T +32 11378467
F +32 11378468
E info@kampmann.be
W Kampmann.be

Représentation Suisse
Tödisstraße 60
8002 Zürich
Suisse

T +41 44 2836-185
F +41 44 2836-186
E info@kampmann.ch
W Kampmann.ch

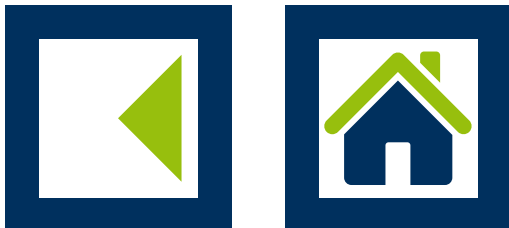

KAMPMANN
Genau mein Klima.