

**RECOLECTORES Y VIBRADORES
RÉCOLTEUSES ET VIBREURS
HARVESTERS AND VIBRATING HEADS**

SolanoGroup

SOLANO  **ORIZONTE**

**ACEITUNAS, ALMENDRAS, NUECES, PISTACHOS
OLIVES, AMANDES, NOIX, PISTACHES
OLIVES, ALMONDS, NUTS, PISTACHIOS**





- Circuito hidráulico con sistema de pistones.
- Pinza monomasa con sistema de vibración múltiple orbital ambas direcciones. ①
- Regulación de la potencia máxima por bomba hidráulica de caudal variable y motor hidráulico de 400 bar, mando en cabina de los movimientos con sirga de control variable de vibración (para tractores de 120-130 CV). ②
- Posibilidad de sistema "bypass" (para tractores de 90 CV). ③
- Movimiento hidráulico de elevación de la pinza. ④
- Movimiento hidráulico de giro de pinza a 35°. ④



- Circuit hydraulique avec système à pistons.
- Pince mono-masse avec système de vibrations orbitale bi-directionnelles. ①
- Régulation de la puissance maxi. par pompe hydraulique à débit variable et moteur hydraulique de 400 bar, boîtier de contrôle des mouvements hydrauliques en cabine avec câble de contrôle variable de vibration (pour tracteurs 120-130 CV). ②
- Possibilité de système "bypass" (pour tracteurs de 90 CV). ③
- Orientation hydraulique verticale de la pince. ④
- Orientation hydraulique transversale à 35° de la pince. ④



- Hydraulic circuit with piston system.
- Single mass head featuring orbital vibrating system in two directions. ①
- Regulation of maximum power through piston pump with variable flow and a 400 bar hydraulic engine, in-cab control box of hydraulic movements and cable for variable control of vibration (for 120-130 HP tractors). ②
- Possibility of bypass system (for 90 HP tractors). ③
- Hydraulic vertical movement of the head. ④
- Hydraulic 35° transversal orientation of the head. ④



SIRGAS



BYPASS

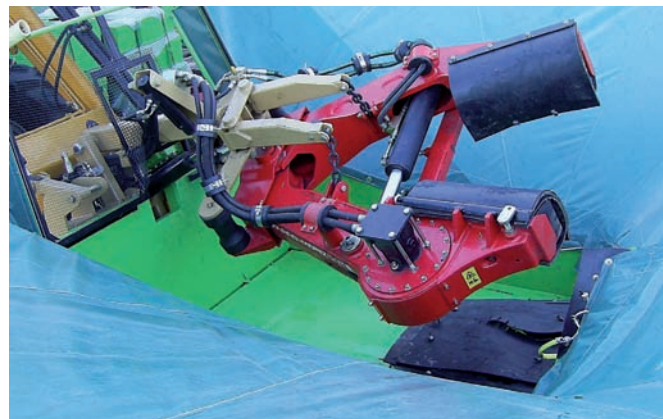



- Central hidráulica a los 3 puntos traseros del tractor, enchufes rápidos y contra-pesas, indicador visual de nivel y temperatura del aceite, termostato y enfriador de aire, filtro de retorno



- Centrale hydraulique aux 3 points arrière du tracteur, prises rapides et contre-poids, indicateur visuel de niveau et de température de l'huile, thermostat et refroidissement par air, filtre de retour



- Hydraulic central mounted on the rear 3 points of the tractor, with quick hydraulic connection plugs and counter-weight, visual indicator for oil level and temperature, thermostat and air cooling, return filter.



③



- Paraguas delantero Ø 7 y 8 m., de diseño ligero y estructura reforzada. ①
- Brazos del paraguas encajados en nylon en ejes macizos, para reducir el desgaste y optimizar las labores de mantenimiento. ②
- Enganche rápido del paraguas. ③



- Caisson de récolte avant de conception légère et renforcée, parapluie Ø 7 y 8 m. ①
- Bras du parapluie inversé avec bague en téflon à l'intérieur d'un axe plein, pour réduire l'usure et optimiser l'entretien. ②
- Attelage rapide du caisson de récolte. ③



- Front harvesting box with light design and reinforced structure, umbrella Ø 7 and 8 m. ①
- Arms of the inverted umbrella with nylon rings sitting into a full axle, to reduce wearing and to optimize maintenance. ②
- Quick hitch system. ③



①

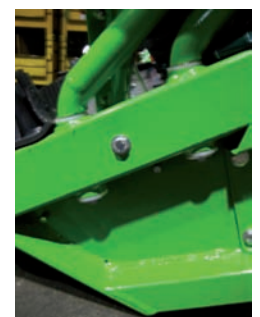

②

MOD.	EXT.	MANDO CONTROL	PARAGUA / PARAPLUIE / UMBRELLA			CV HP
			a	b	Ø	
R90	-	SIRGAS	-	90	7 m	120
R90 X	-	BYPASS	-	90	7 m	90
R90 PH	-	SIRGAS	SI	90	7 m	130
R120	400 mm	SIRGAS	-	120	8 m	120
R120 PH	400 mm	SIRGAS	SI	120	8 m	130
R130	400 mm	SIRGAS	-	130	8 m	120
R130 PH	400 mm	SIRGAS	SI	130	8 m	130

a: abatible; b: boca paragua / a: rabaisable; b: bouche caisson / a: lowerable; b: box mouth

4 MODELOS DE PARAGUAS / 4 MODÈLES DE CAISSONS / 4 MODELS OF HARVESTING BOXES

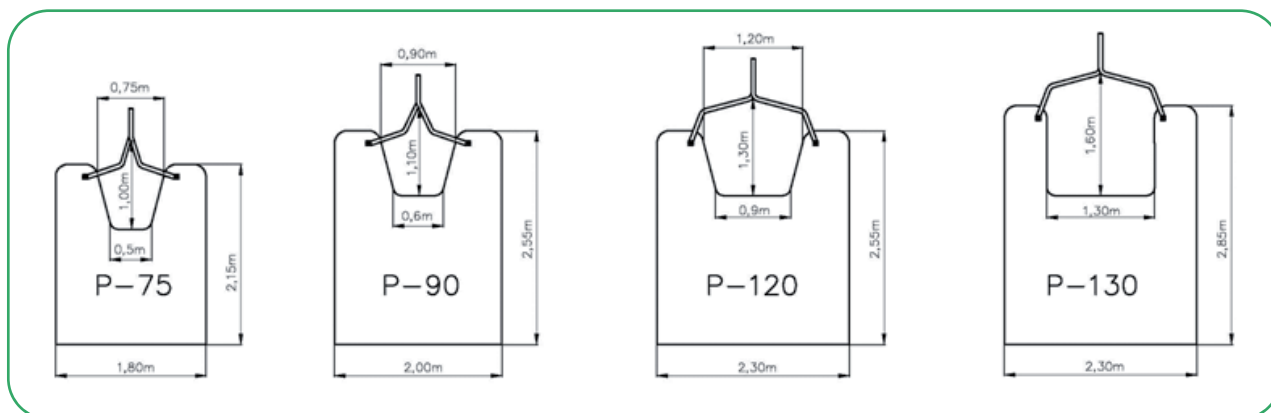

OPCIONES - OPTIONS

PARAGUAS ABATIBLE / PARAPLUIE RABAISSABLE / LOWERABLE UMBRELLA

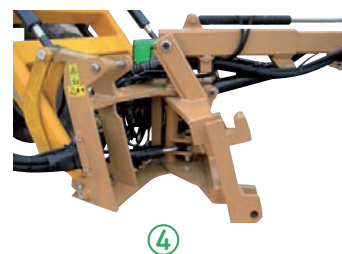

- Kits para olivo joven.
- Avance soporte mazo. ①
- Protector cilindro pinza. ②
- Extensión pinza 400 mm. ③
- Movimiento lateral pinza.
- Movto. lateral pinza+paraguas. ④
- Paraguas abatible.
- Suplementos y Ø paraguas.



- Kits oliviers "jeunes".
- Kit réduction ouverture pince. ①
- Protection verin de pinces. ②
- Extension de pince 400 mm. ③
- Mouvement latéral de la pince.
- Mvt. latéral caisson+pinces. ④
- Parapluie rabaisable.
- Suppléments et Ø parapluie.



- Young tree kits.
- Kit to reduce the opening width of head. ①
- Protection of hydraulic cylinder of pincers. ②
- 400 mm hydraulic extension of the heads. ③
- Hydraulic lateral orientation of the head.
- Lateral hydr movement of head + harv. box. ④
- lowerable umbrella.
- Suppléments et Ø of umbrella.

OLIVO JOVEN / OLIVIERS JEUNES / YOUNG OLIVE TREES

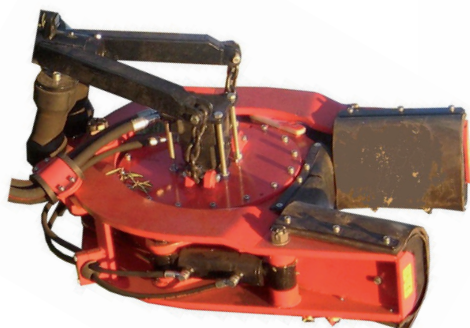

- Pinza monomasa, circuito hidráulico con sistema de pistones.
- Regulación de la potencia máxima por bomba hidráulica de caudal variable y motor hidráulico de 400 bar, mando en cabina de los movimientos con sistema "bypass" (90 CV)
- Central hidráulica trasera (idéntica a la que se monta en serie 130)
- Cajón delantero reforzado, paraguas Ø 6m con brazos abatibles manualmente, encasquillados en nylon en ejes macizos, para reducir el desgaste y optimizar mantenimiento.
- Cinta transportadora del fruto al depósito y sinfín dentro de la tolva para un reparto homogéneo.
- Cámara de visión de acceso al árbol.
- Sensor de nivel de tolva.
- Altura de descarga: hasta 2,80 mts (segun tractor).



- Pince mono-masse, circuit hydraulique avec système à pistons.
- Régulation de la puissance maxi. par pompe hydraulique à débit variable et moteur hydraulique de 400 bar, boîtier de contrôle des mouvements hydrauliques avec système "bypass" (pour tracteurs de 90 CV).
- Centrale hydraulique arrière (idem à série 130).
- Caisson renforcée, parapluie Ø 6m avec bras rabaisables manuellement, bagués en téflon à l'intérieur d'un axe plein, pour réduire l'usure et optimiser l'entretien.
- Chenille de transport des olives au caisson et vis sans fin pour répartir de façon homogène les olives dans le caisson.
- Caméra pour visionner l'accès au tronc.
- Capteur de niveau du caisson de récolte.
- Hauteur de déchargement jusqu'à 2,80 mts (selon tracteur).



- Single mass head, hydraulic circuit with piston system.
- Regulation of maximum power through piston pump with variable flow and a 400 bar hydraulic engine, in-cab control box of hydraulic movements with bypass system (90 HP tractor).
- Rear hydraulic central (same as 130 serie)
- Reinforced box, manually lowerable Ø 6 m. umbrella's arms, with nylon rings sitting into a full axle, to reduce wearing and to optimize maintenance.
- Conveyor belt to transport olives to the box and endless screw inside box to give homogeneity to the olives.
- Closed circuit camera to see head & trunks from the tractor.
- Level sensor in the harvesting box.
- Unloading height superior to 2,80 metres (depends on tractor).



MOD.	EXT.	MANDO CONTROL	PARAGUAS / PARAPLUIE / UMBRELLA			CV HP
			a	b	Ø	
R60 OLJ	-	-	SI	-	6 m	90
R 60 OLJ-X	-	BYPASS	SI	-	6 m	90

a: abatible; b: boca paragua / a: rabaisable; b: bouche caisson / a: lowerable; b: box mouth



- Pinza monomasa con motor de vibración de fundición, y sistema de vibración múltiple orbital ambas direcciones.
- Mando en cabina de los movimientos con sistema "bypass" (para tractores de 100 CV).
- Movimiento hidráulico de elevación de la pinza.
- Movimiento hidráulico de giro de pinza a 35°.



- Pince mono-masse avec moteur de vibrations en fonte, et système de vibrations orbitale bi-directionnelles.
- Boîtier de contrôle des mouvements hydrauliques en cabine avec système "bypass" (pour tracteurs de 100 CV).
- Orientation hydraulique verticale de la pince.
- Orientation hydraulique transversale à 35° de la pince.



- Single-mass head with vibration engine in cast iron, featuring orbital vibrating system in two directions.
- In-cab control box of hydraulic movements with bypass system (for 100 HP tractors).
- Hydraulic vertical movement of the head.
- Hydraulic 35° transversal orientation of the head.



- Centrale hydraulique aux 3 points arrière du tracteur, prises rapides et, indicateur visuel de niveau et de température de l'huile, thermostat et refroidissement par air, filtre de retour.



- Central hidráulica a los 3 puntos traseros del tractor, enchufes rápidos, indicador visual de nivel y temperatura del aceite, termostato y enfriador de aire, filtro de retorno.







- Hydraulic central mounted on the rear 3 points of the tractor, with quick hydraulic connection plugs, visual indicator for oil level and temperature, thermostat and air cooling, return filter.



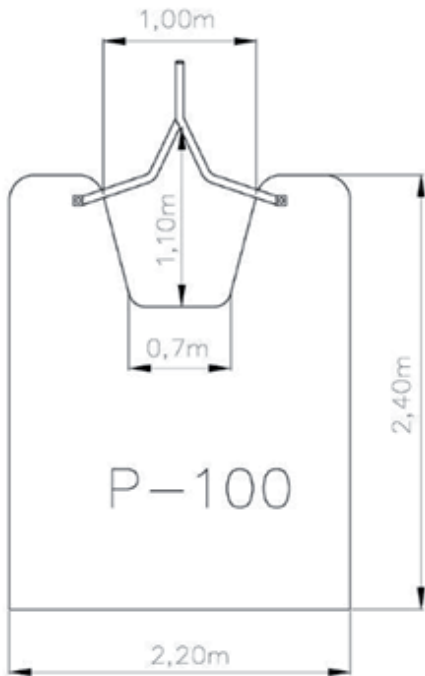







MOD.	EXT.	MANDO CONTROL	PARAGUAS / PARAPLUIE / UMBRELLA			CV HP
			a	b	Ø	
R100 P 7	opción	-	-	100	7 m	100
R100 P 8	opción	-	-	100	8 m	100
R100 PB 6	opción	-	SI	100	6 m	100
R100 PB 7	opción	-	SI	100	7 m	100
R100 PH 8	opción	-	SI	100	8 m	100

a: abatible; b: boca paragua / a: rabaisable; b: bouche caisson / a: lowerable; b: box mouth



-  - Paraguas delantero Ø 7 y 8 m., de diseño ligero y estructura reforzada. ①
-  - Brazos del paraguas encasquillado en nylon en ejes macizos, para reducir el desgaste y optimizar las labores de mantenimiento. ②
-  - Enganche rápido del paraguas. ③
-  - Paraguas fijo, abatible manualmente, abatible hidráulicamente según modelo escogido.

-  - Caisson de récolte avant de conception légère et renforcée, parapluie Ø 7 y 8 m. ①
-  - Bras du parapluie inversé avec bague en téflon à l'intérieur d'un axe plein, pour réduire l'usure et optimiser l'entretien. ②
-  - Attelage rapide du caisson de récolte. ③
-  - Parapluie fixe, rabattable manuellement, rabattable hydrauliquement selon modèle choisi.

-  - Front harvesting box with light design and reinforced structure, umbrella Ø 7 y 8 m. ①
-  - Arms of the inverted umbrella with nylon rings sitting into a full axle, to reduce wearing and to optimize maintenance. ②
-  - Quick hitch system. ③
-  - Type of umbrellas: fixed arms, manually lowerable, hydraulically lowerable (depending on selected model).

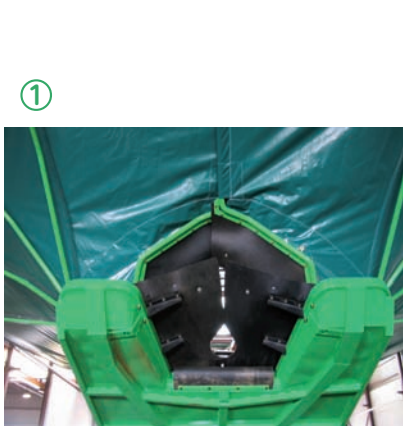











Paraguas fijo / Parapluie fixe / Fixed umbrella







Abatible / Rabattable / Lowerable

OPCIONES - OPTIONS

-  - Protector cilindro pinza.
-  - Kit para olivo joven.
-  - Contra-pesas en central trasera.
-  - Extensión pinza 350 mm.
-  - Suplementos y Ø paraguas.

-  - Protection verin de pinces.
-  - Kit oliviers "jeunes".
-  - Contre-poids centrale hydr.
-  - Extension de pince 350 mm.
-  - Suppléments et Ø parapluie.

-  - Protection of hydraulic cylinder of pincers.
-  - Young tree kit.
-  - Counter-weight on hydraulic central.
-  - 350 mm hydraulic extension of the heads.
-  - Supplements et Ø of umbrella.



- Recolector mixto: aceitunas, almendras, nueces, pistachos,..

- Pinza monomasa con mando de regulación de frecuencia en cabina.
- Sistema hidráulico de alta presión (220 bar) con:
 - * Vibración reversible.
 - * Freno de vibración.
 - * Auto-apriete de la pinza.
- Distribuidor eléctrico profesional para:
 - * abrir/cerrar pinza
 - * poner en marcha/parar las peladoras.
 - * vibración adicional para aceituna.



- Récolteuse mixte pour olives, amandes, noix, pistaches, etc.

- Pince mono-masse avec boîtier de régulation de fréquence en cabine.
- Système hydraulique haute pression (220 bar) avec:
 - * vibration réversible.
 - * Frein de vibration.
 - * Auto-serrage de pince.
- Boîtier électronique pour:
 - * ouvrir/fermer la pince.
 - * mettre en route/arrêter les écaleuses.
 - * vibration supplémentaire pour oliviers.



- Mixed harvester: olives, almonds, nuts, pistachios,..

- Mono-mass head with frequency regulation on the in-cab control box.
- 220 bar high pressure hydraulic system with:
 - Reversible vibrations.
 - Vibration brake.
 - Automatic pressure of head closing.
- Professional control box to:
 - * open/close head's pincers.
 - * run/stop peelers.
 - * run/stop extra-vibration for olive shaking.



MOD.	EXT.	PQ	PARAGUAS / PARAPLUIE / UMBRELLA			CV HP
			a	b	Ø	
R90 MIX	opción	opción	SI	2	7 m	90

pq: desengache rápido paraguas ; a: respaldo abatible; b: peladora
 pq: dételage rapide du caisson; a: grille protection rabaisable; b: écaleuse
 pq: quick box unhitching; a: lowerable protection; b: peeler

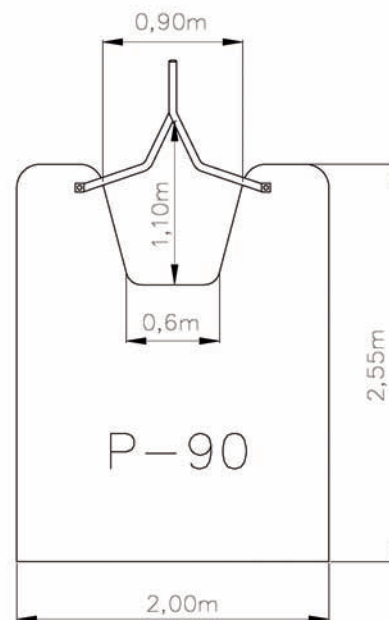

- Central hidráulica a los 3 puntos traseros del tractor, enchufes rápidos y contra-pesas, indicador visual de nivel y temperatura del aceite, termostato y enfriador de aire, filtro de retorno.



- Centrale hydraulique aux 3 points arrière du tracteur, prises rapides et contre-poids, indicateur visuel de niveau et de température de l'huile, thermostat et refroidissement par air, filtre de retour.



- Hydraulic central mounted on the rear 3 points of the tractor, with quick hydraulic connection plugs and counter-weight, visual indicator for oil level and temperature, thermostat and air cooling, return filter.

OPCIONES - OPTIONS



①

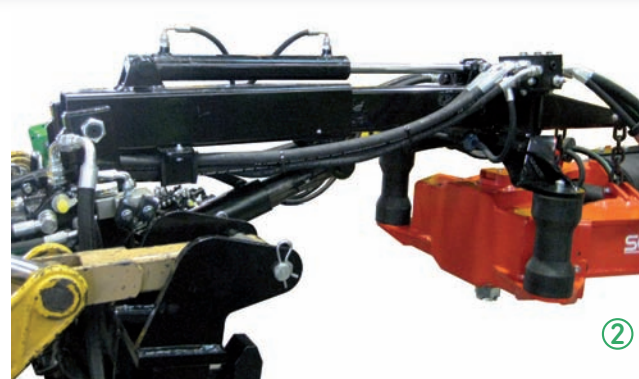

②

- Desenganche del paraguas rápido. ①
- Extensión pinza 400 mm. ②



- Dételage rapide du caisson. ①
- Extension de pince 400 mm. ②



- Quick box unhitching. ①
- 400 mm hydraulic extension of the heads. ②



- Pinza bi-masa, sistema de vibración orbital en ambas direcciones.
- Estructura de cajón reforzada.
- Modelos RD 75 & RD 75P: paraguas Ø 6.5 m.
- Modelos RD 90 & RD 90P: paraguas Ø 7 m.
- Gran altura de descarga (hasta 3 metros, según tractor)
- Mando eléctrico en cabina.
- Movimientos de apertura de paraguas y pinza simultáneos.
- Regulación independiente de la velocidad de apertura/cierre del paraguas.
- Modelos con peladoras (RD 75P & RD 90P): 2 peladoras con regulación independiente y fácil acceso para mantenimiento.
- Modelos RD 90 & RD 90 P: elevación de pinza



- Two-mass head featuring orbital vibrating system in 2 directions.
- Reinforced structure of the harvesting box.
- Models RD 75 & RD 75P: inverted umbrella Ø 6.5 m.
- Models RD 90 & RD 90P: inverted umbrella Ø 7 m.
- Unloading height up to 3 metre (depending on tractor).
- In-cab electrical control box.
- Simultaneous movements of umbrella opening and head's pincers.
- Hydraulic vertical movement of the head.
- Independant regulation for the opening/closing speed of umbrella.
- Models with peelers (RD 75P & RD 90P): 2 peelers with independant regulation and easy access for maintainance.
- Models RD 90 & RD 90 P: Hydraulic vertical movement of the head.



RD 75 & RD 75 P

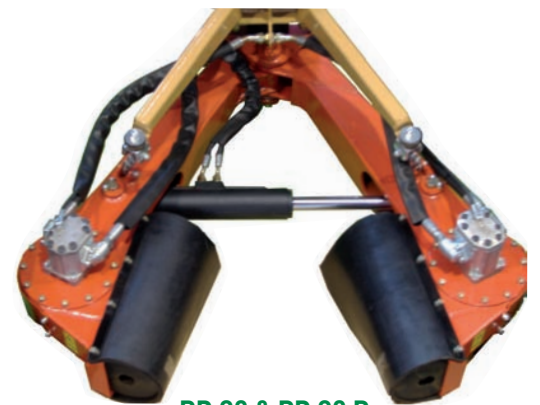

RD 90 & RD 90 P



- Pince bi-masse avec système de vibrations orbitale bi-directionnelles.
- Structure du caisson renforcée.
- Modèles RD 75 & RD 75P: parapluie inversé Ø 6.5 m.
- Modelos RD 90 & RD 90P: parapluie inversé Ø 7 m.
- Grande hauteur de déchargement
- Boîtier de commandes électrique en cabine.
- Mouvements simultanés d'ouverture de parapluie et pince.
- Régulation indépendante de la vitesse d'ouverture/fermeture du parapluie inversée.
- Modèles avec écaleuses (RD 75P & RD 90P): 2 écaleuses avec régulation indépendante et accès facile pour l'entretien.
- Modèles RD 90 & RD90P: Orientation hydraulique verticale de la pince.

MOD.	EXT.	PQ	PARAGUA / PARAPLUIE / UMBRELLA			CV HP
			a	b	Ø	
RD 75	opción	opción	SI	-	6,5 m	70
RD 75 P	opción	opción	SI	2	6,5 m	70
RD 90	opción	opción	SI	-	7,0 m	70
RD 90 P	opción	opción	SI	2	7,0 m	70

pq: desengache rápido paraguas ;
a: respaldo abatible; b: peladora

pq: dételage rapide du caisson;
a: grille protection rabaisable;
b: écaleuse

pq: quick box unhitching;
a: lowerable protection; b: peeler

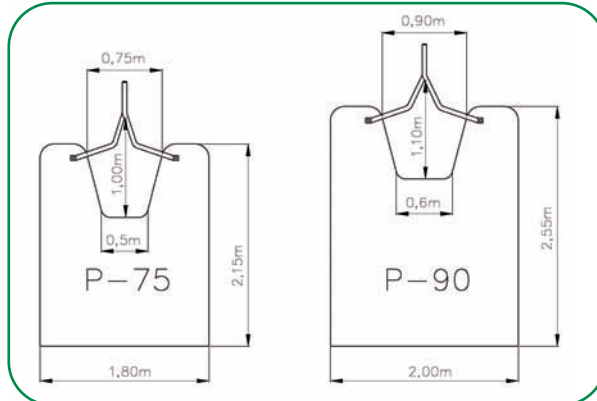
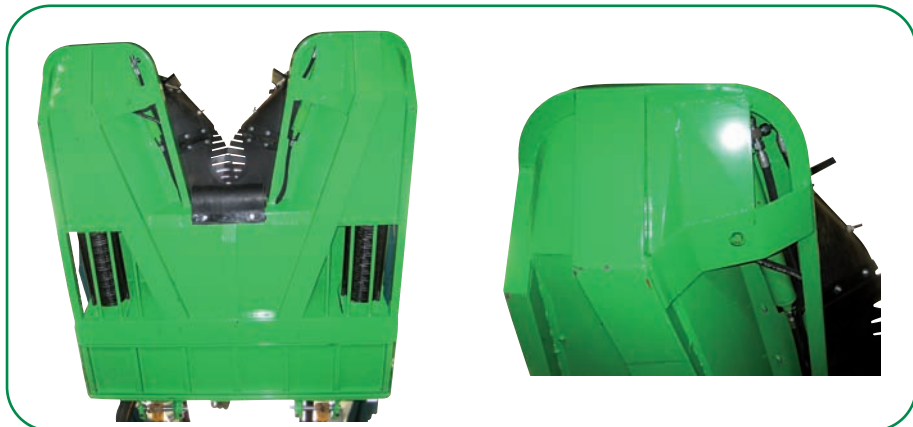

- Central hidráulica a los 3 puntos traseros del tractor, enchufes rápidos y contra-pesas, indicador visual de nivel y temperatura del aceite, termostato y enfriador de aire, filtro de retorno.



- Centrale hydraulique aux 3 points arrière du tracteur, prises rapides et contre-poids, indicateur visuel de niveau et de température de l'huile, thermostat et refroidissement par air, filtre de retour.



- Hydraulic central mounted on the rear 3 points of the tractor, with quick hydraulic connection plugs and counter-weight, visual indicator for oil level and temperature, thermostat and air cooling, return filter.

OPCIONES - OPTIONS



- Mando secuenciador (sistema automatizado de trabajo).
- Juego de tapahuecos peladoras.
- Extensión pinza 400 mm.
- Suplementos y Ø paraguas.
- Desenganche de paraguas rápido.



- Boîtier de travail séquentiel automatisé.
- Jeu de caches pour écaleuses.
- Extension de pince 400 mm.
- Suppléments et Ø parapluie.
- Kit dételage rapide du caisson.



- Control box with automated working sequences.
- Set of cover for peelers.
- 400 mm hydraulic extension of the heads.
- Supplements et Ø umbrella.
- Kit for quick unhitching of harvesting box.



- Modelo compacto trasero a los 3 puntos, ideal para tractores fruteros (70 cv).
- Tercer punto hidráulico (latiguillos directo al tractor).
- Pinza bi-masa, sistema de vibración orbital en ambas direcciones.
- Estructura de cajón reforzada
- Paraguas invertido Ø 6.5 m.
- Gran altura de descarga. ① (hasta 2,30 metros, según tractor)
- Mando eléctrico en cabina.
- Movimientos de apertura de paraguas y pinza simultáneos.
- Regulación independiente de velocidad de apertura/cierre del paraguas. ②
- Sinfin de descarga, con regulación variable (latiguillos directos al tractor). ③
- 1 peladora, regulación independiente. ④
- Central hidráulica integrada enfriador.



- Modèle compact, attelage aux 3 points, idéal pour tracteurs fruitiers (70 cv).
- Troisième point hydraulique (flexibles directs au tracteur).
- Pince bi-masse, système de vibrations orbitales bi-directionnelles.
- Structure du caisson renforcée.
- Parapluie inversé Ø 6.5 m.
- Grande hauteur de déchargement ① (jusqu'à 2,30 mètres, selon tracteur)
- Boîtier commandes électrique en cabine.
- Mouvements simultanés d'ouverture de parapluie et pince.
- Régulation indépendante de la vitesse d'ouverture/fermeture du parapluie. ②
- Vis sans fin de déchargement, régulation variable (flexibles directs au tracteur). ③
- 1 écaleuse, régulation indépendante. ④
- Centrale hydr. intégrée avec réfrigération.



- Compact model, 3-point hitching, idoneous for fruit-tree tractors (70 hp).
- Hydraulic 3rd point (hydr. pipe direct to the tractor).
- Bi-mass head, orbital vibrating system in 2 directions.
- Reinforced structure of the box.
- Inverted umbrella Ø 6.5 m.
- Unloading height up to 2,30 metres ① (depending on tractor).
- In-cab electrical control box.
- Simultaneous movements of umbrella opening and head's pincers.
- Independent regulation for the opening/closing speed of umbrella. ②
- Unloading endless screw, with independent regulation (hydraulic pipe direct to the tractor) ③
- 1 peeler, independent regulation. ④
- Integrated hydr. central with oil cooling.

MOD.	EXT.	HY 3°	PARAGUA / PARAPLUIE / UMBRELLA			CV HP
			a	b	Ø	
RD 75	-	-	SI	1	6,5 m	70

HY 3°: cilindro en 3° punto; a: respaldo abatible; b: peladora
 HY 3°: verin sur 3° point; a: grille protection rabaisable; b: écaleuse
 HY 3°: cylinder on 3rd point; a: lowerable protection; b: peeler



①



②



③

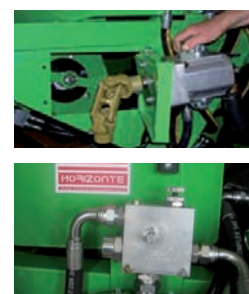

④