

Une table de conférence à la taille de votre entreprise !

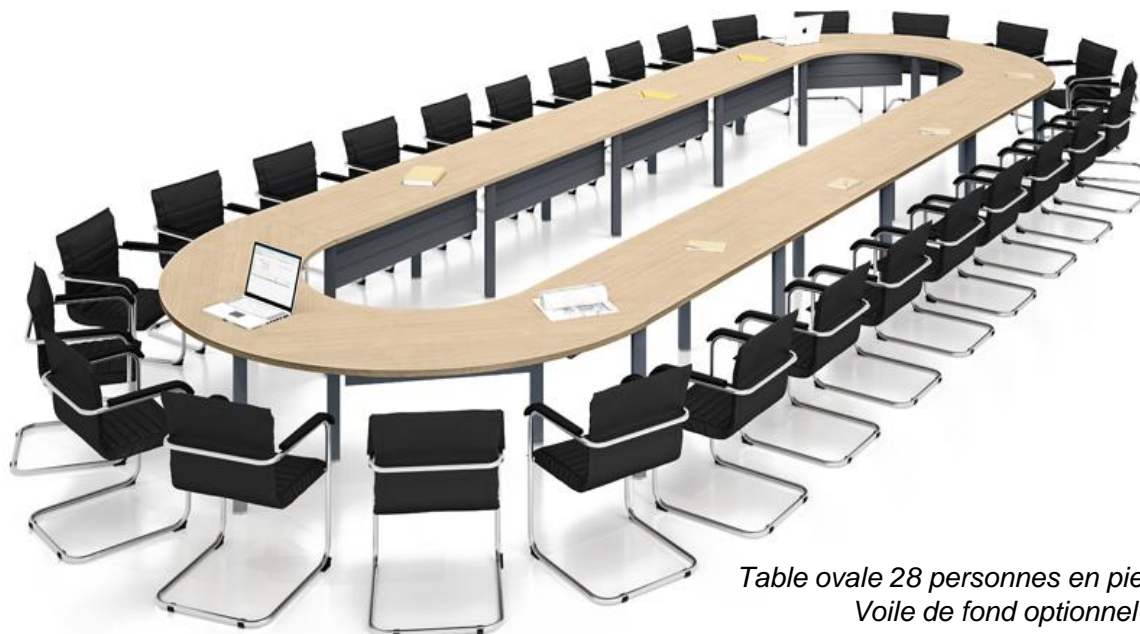

*Table ovale 28 personnes en pieds ronds
Voile de fond optionnel*

Une table de conférence modulaire de très belle finition, proposée avec 3 piètements différents et 2 plateaux différents :

- Pieds panneau pour l'élégance.
- Pieds ronds Ø70 mm ou carrés 60x60 mm pour la modernité et le budget.
- Plateau mélaminé : BUSINESS ép.30 mm ou PRIVILEGE ép.38 mm.



*Table elliptique en pied panneau
kit top-access central optionnel*



3 types de piètement

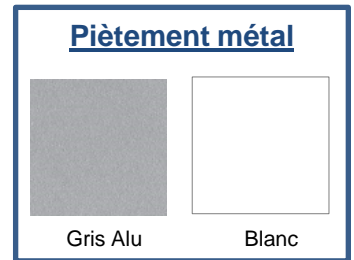
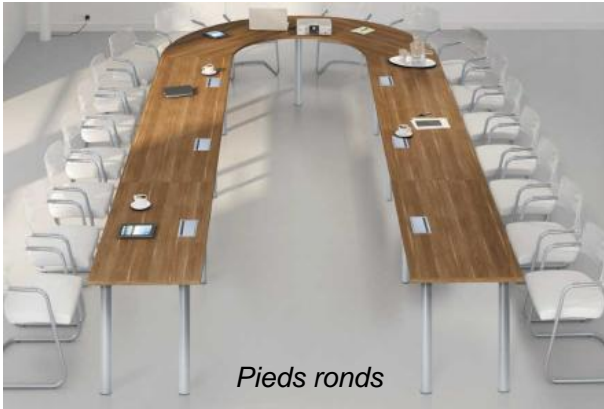

Les pieds sont partagés entre plusieurs plateaux, permettant une économie de pieds (= économie budgétaire, et davantage de fluidité esthétique)

5 finitions de plateau

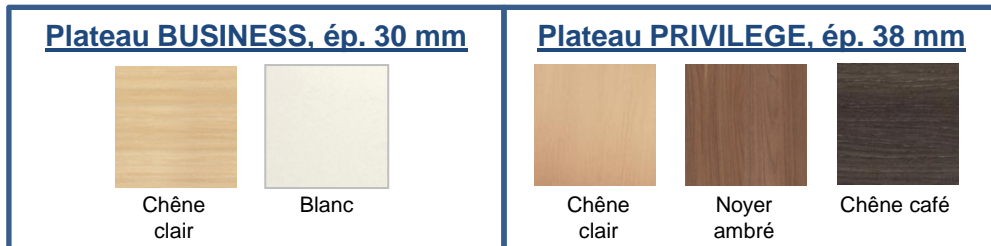

7 formes de plateau

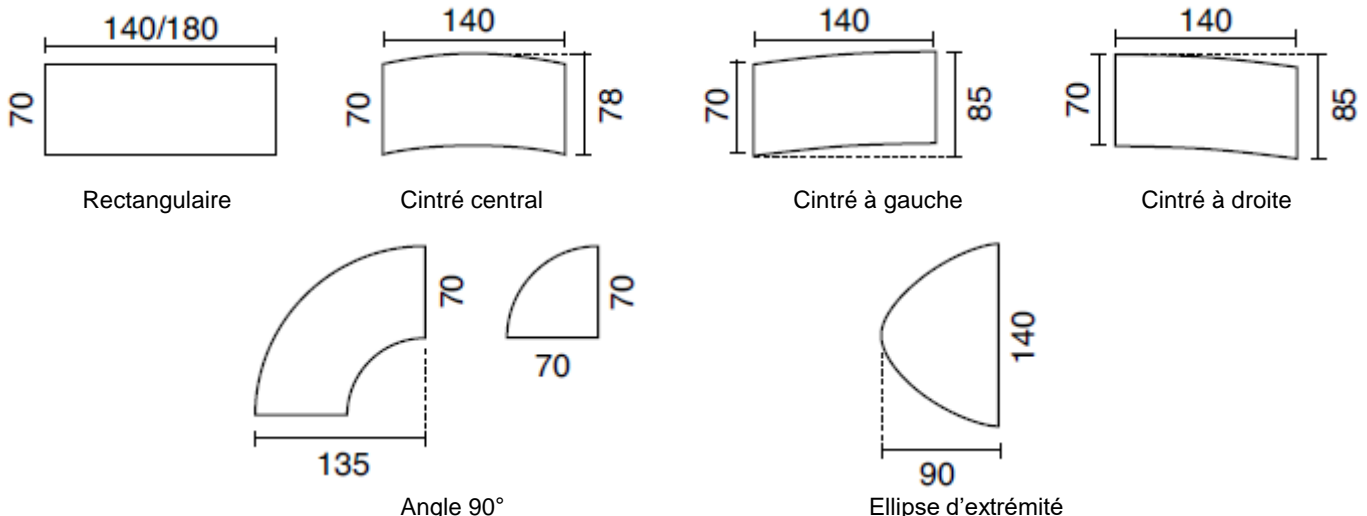

Voile de fond métallique



Électrification



Espace « top-access » sur les tables de forme elliptique, comblant l'espace vide entre les tables.



Trappe top-access sur les plateaux rectangulaires.
En option, fourniture des blocs prise (220V + RJ45 + USB)

10 personnes

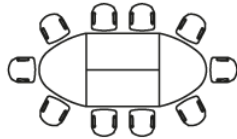

Table ovale
L320 x P140

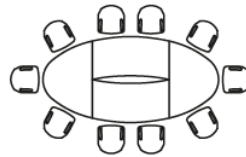

Table elliptique
L320 x P156

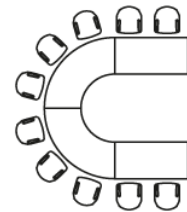

Table en U
L275 x P270

12 personnes

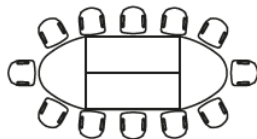

Table ovale
L360 x P140

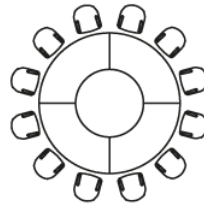

Table ronde
Ø270

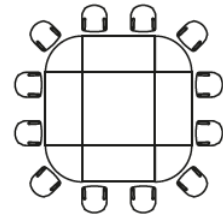

Table carrée
L280 x P280

14 personnes

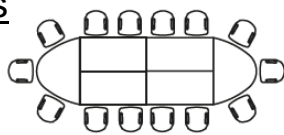

Table ovale
L460 x P140

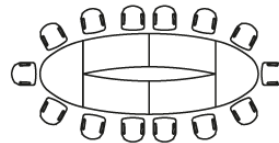

Table elliptique
L460 x P170

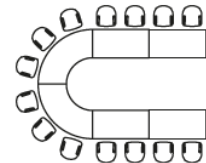

Table en U
L415 x P270

18 personnes

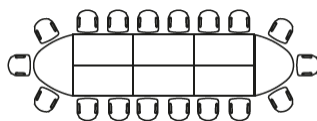

Table ovale
L600 x P140

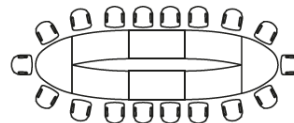

Table elliptique
L600 x P170

20 personnes

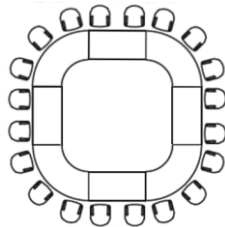

Table carrée
L410 x P410

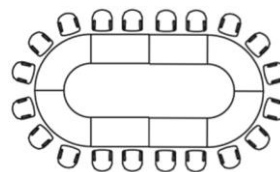

Table ovale
L550 x P270

24 personnes

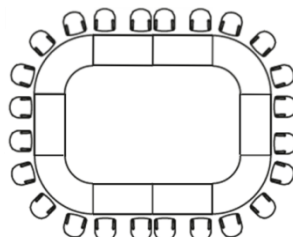

Table ovale
L550 x P410

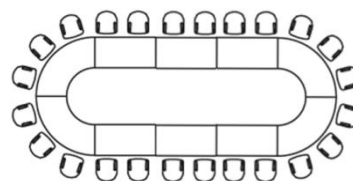

Table ovale
L690 x P270