

TruLaser

Cost-effective
cutting through
thick and thin

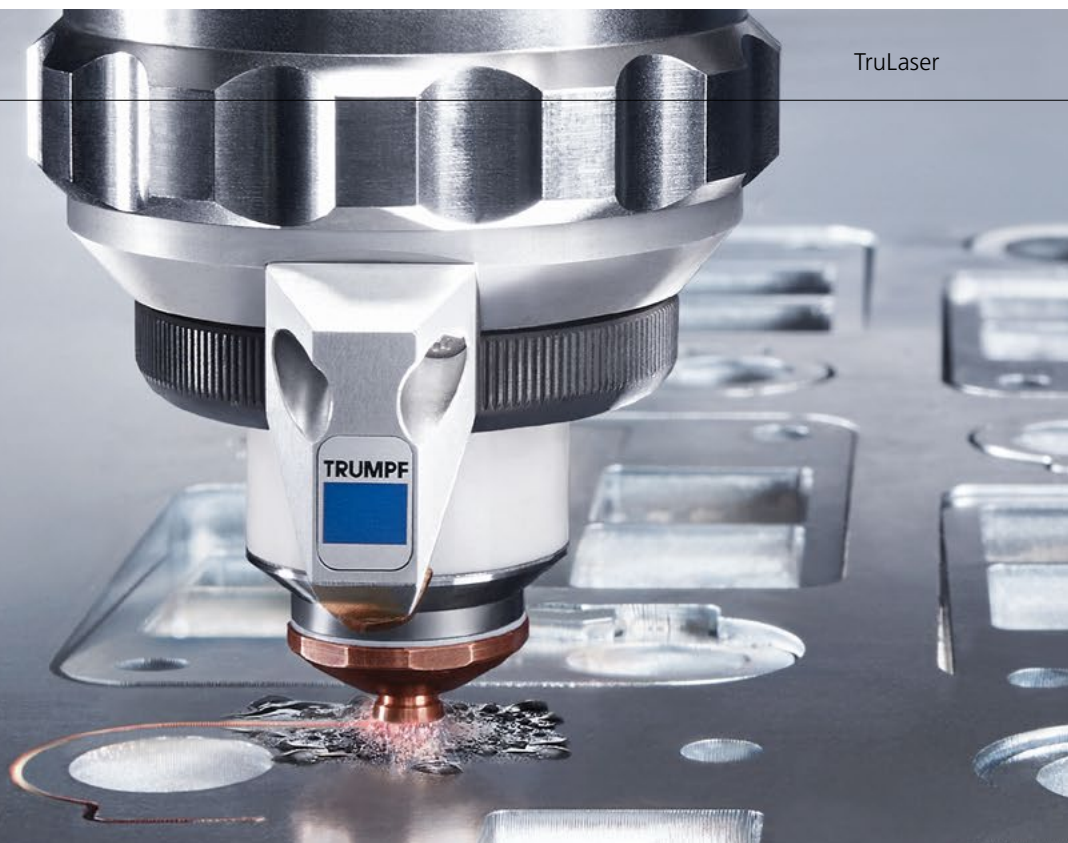

The best solution for your application

The right laser for your cutting application, the right machine for your production, the automation that matches your material flow – this is what TRUMPF delivers. Our large range of laser cutting machines assures that you receive the right product. The vital questions for choosing the right machine are about your situation: What are your requirements regarding material and quality? How high is your average capacity? What do you need to make your manufacturing as cost-effective as possible?

Laser cutting is not only about cutting times. The entire process is important. Intelligent functions, for instance, help to design single processing steps in a smarter way. A large service network supports you if necessary. With TRUMPF, you receive suitable solutions: perfectly balanced, highly productive and passionately crafted.

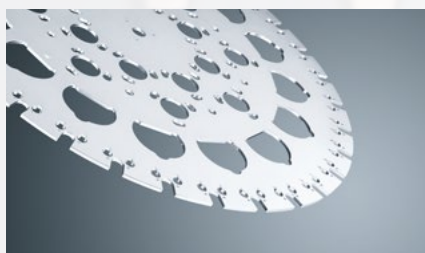
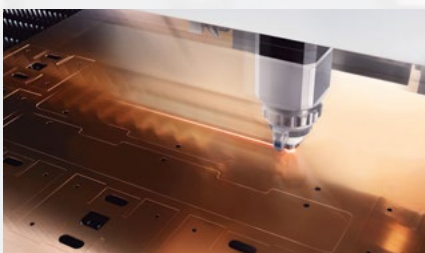

Choose the laser that best suits your application.

CO₂ or solid-state? 4–7

Design your processes efficiently and use the full potential of your machine.

More output with intelligent functions 8–9

Get to know the TruLaser machines.

Our machines in detail 10–31

In this section you can find an overview of the technical details of all TruLaser machines.

Technical data 32–35

Select the right automation solution or switch directly over to the fully automatic laser machine.

Automation and TruLaser Center 7030 36–41

With our TruConnect solutions, we support you every step of the way to implementation of your Smart Factory.

Take control 42–43

With TruServices, you enjoy the benefits of a quotation that goes far beyond the machine itself.

Everything from a single source 44–47

CO₂ or solid-state: The right ty

The question of the right beam source arises in almost every machine purchase. There is no general right or wrong answer. Different factors are important. TRUMPF offers the entire spectrum of beam sources for 2D laser cutting – your material mix, your sheet thicknesses and your quality requirements decide which laser your TRUMPF advisor will recommend.

CO₂ lasers: Consistently perfect edges

CO₂ lasers are an established type of industrial laser, featuring high durability and robustness. The cut edges they produce are of such high quality that reworking is usually unnecessary. The reason for this is that TruFlow lasers operate at a wavelength of 10.6 μm , ensuring edges with no burrs and extremely low roughness depths which are therefore immediately ready for further processing.

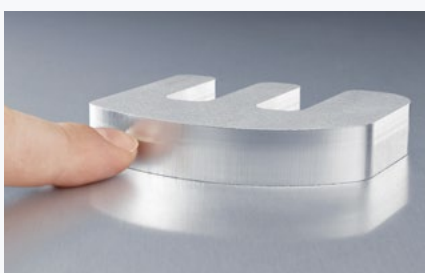
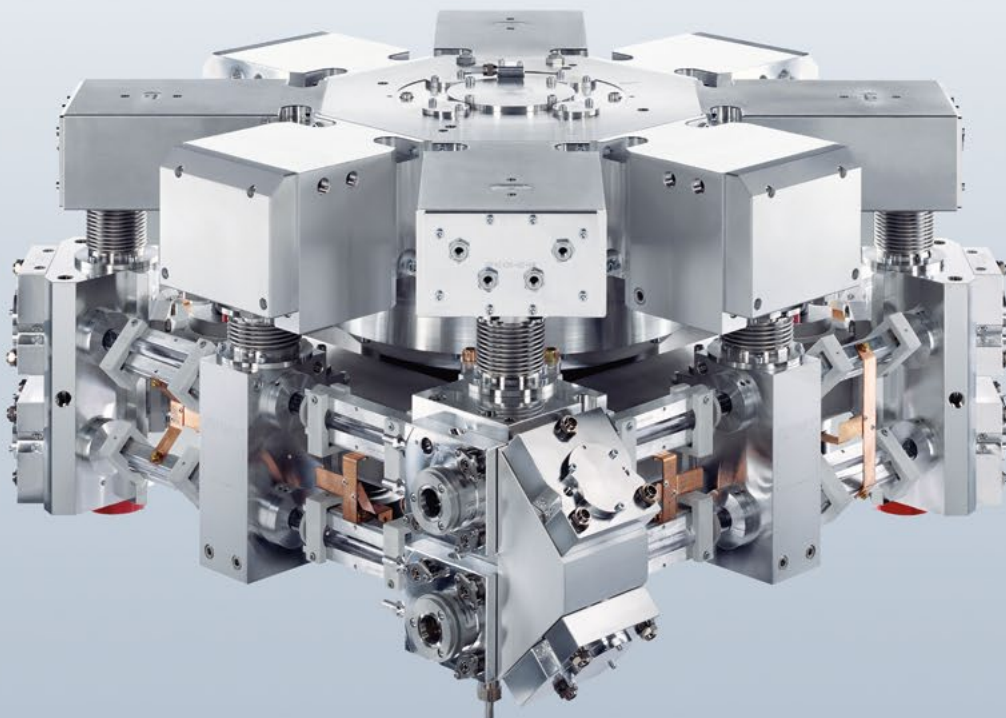

Areas of application

CO₂ lasers are particularly effective for any applications that require especially smooth and high-quality cut edges. They are the right choice for cutting edges that will be visible and where smooth edges matter for the further processing of your part.

pe of laser



The TRUMPF advantage

Lasers are complex high-tech products. In order to ensure that your beam source works in perfect harmony with your optics, machine and software, we develop and produce all components ourselves. This ensures that you can always rely on an exceptional complete package and all-round expert advice.

Solid-state lasers: Highly productive all-rounders

TruDisk solid-state lasers enable you to work quickly, particularly in thin sheet metal. This is possible because they emit a beam with a wavelength of approximately $1.03 \mu\text{m}$, which is absorbed significantly more intensely than the wavelength of CO_2 lasers: these lasers transfer more energy to the sheet metal, enabling cutting to be carried out more quickly.

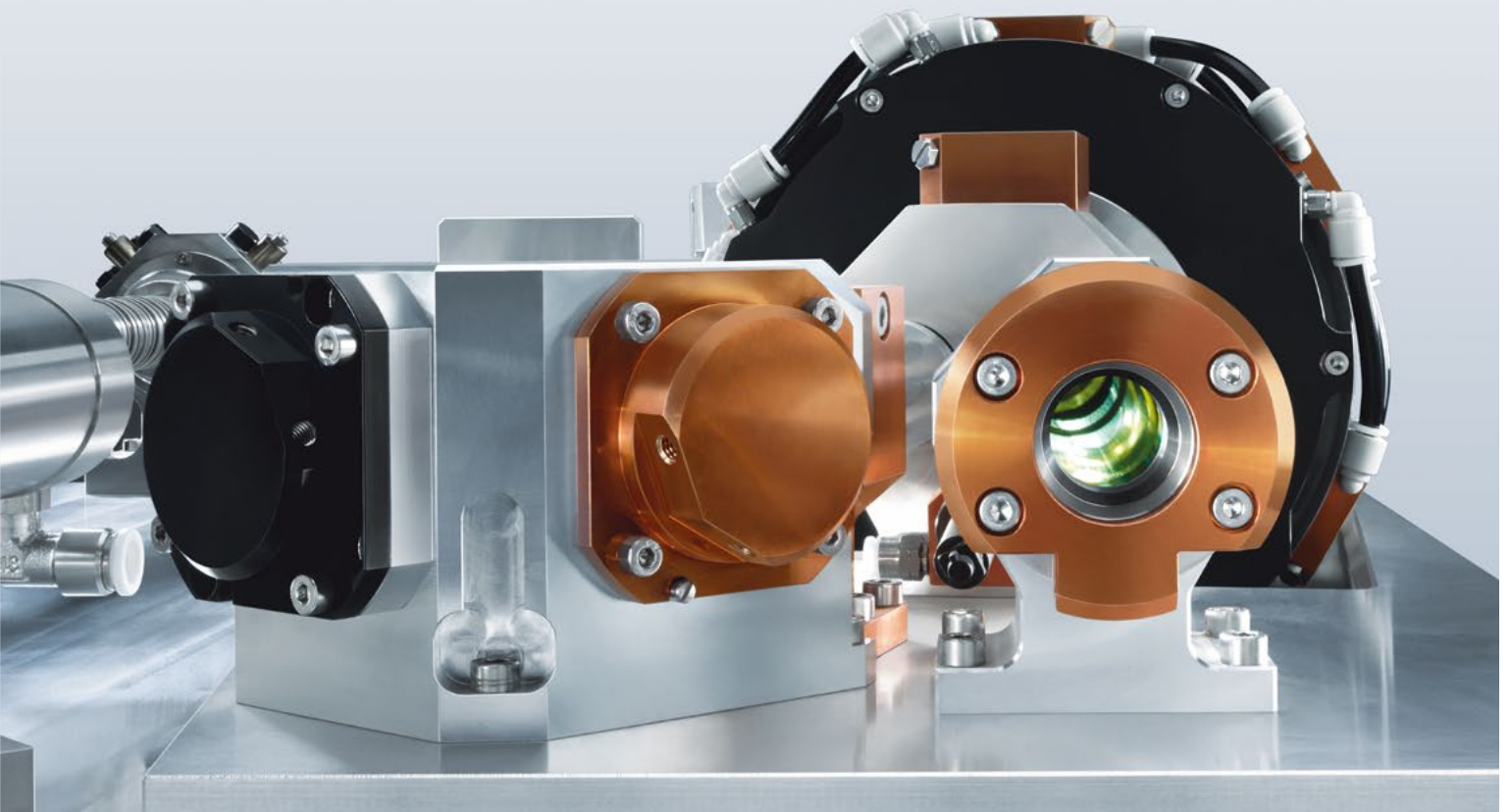

Areas of application

Unlike CO_2 lasers, solid-state lasers are also suitable for cutting copper or brass. When integrated into a laser network, your TruDisk can supply multiple machines. This increases the capacity of your laser and enables you to economically expand your machinery.

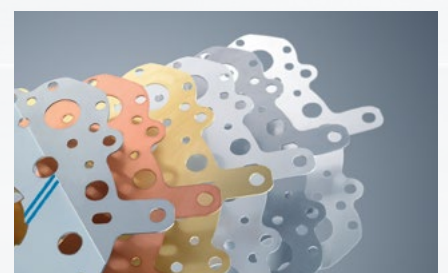

CO₂ or solid-state: Differences

When selecting a laser, one criterion is often particularly important – the cut edge. Consider these comparisons between edges:

Stainless steel and non-ferrous metal

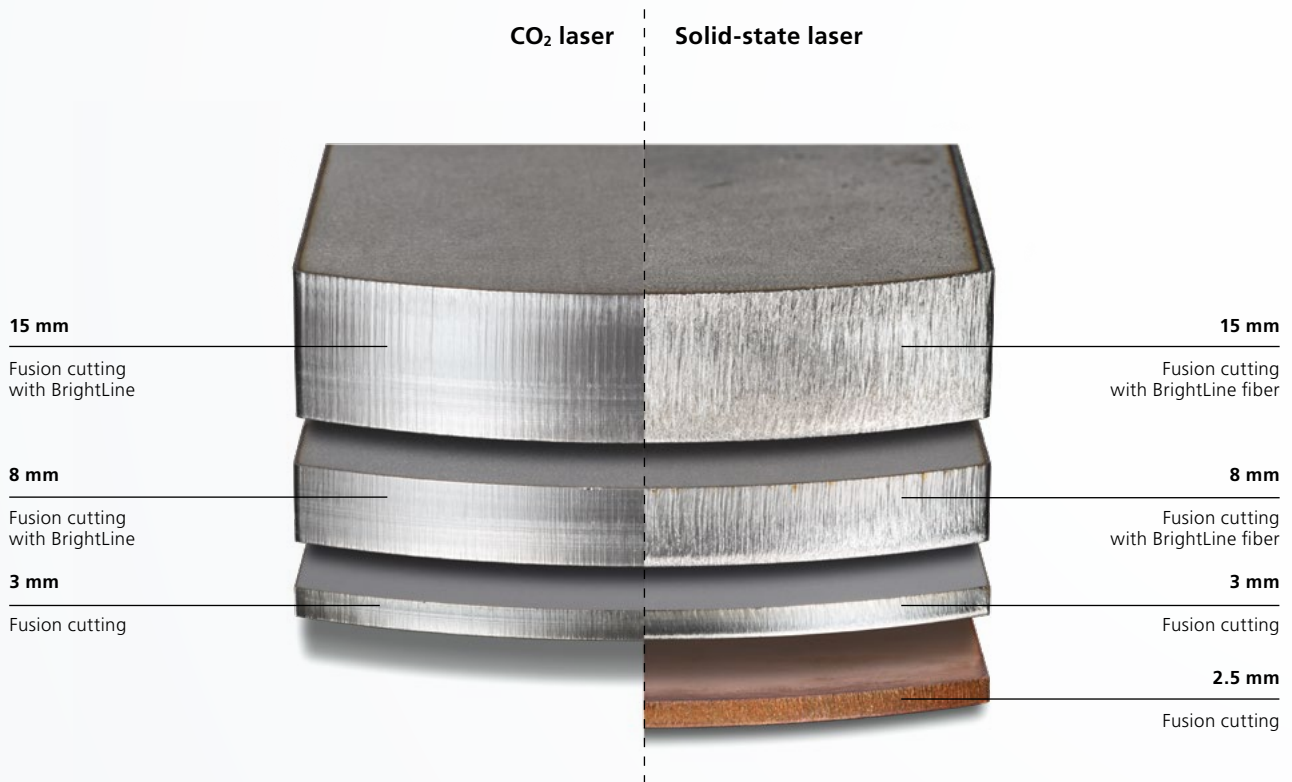

The result:



- CO₂ laser:** Exceptional part quality with extremely smooth and partly reflective edges – with BrightLine for thick sheet metal, and without BrightLine for thin sheet metal. Virtually no burr formation.
- Solid-state laser:** Excellent part quality with thin sheet metal, assisted by BrightLine fiber with thicker sheet metal to ensure a consistent sectional view.

in the cutting edge

Structural steel

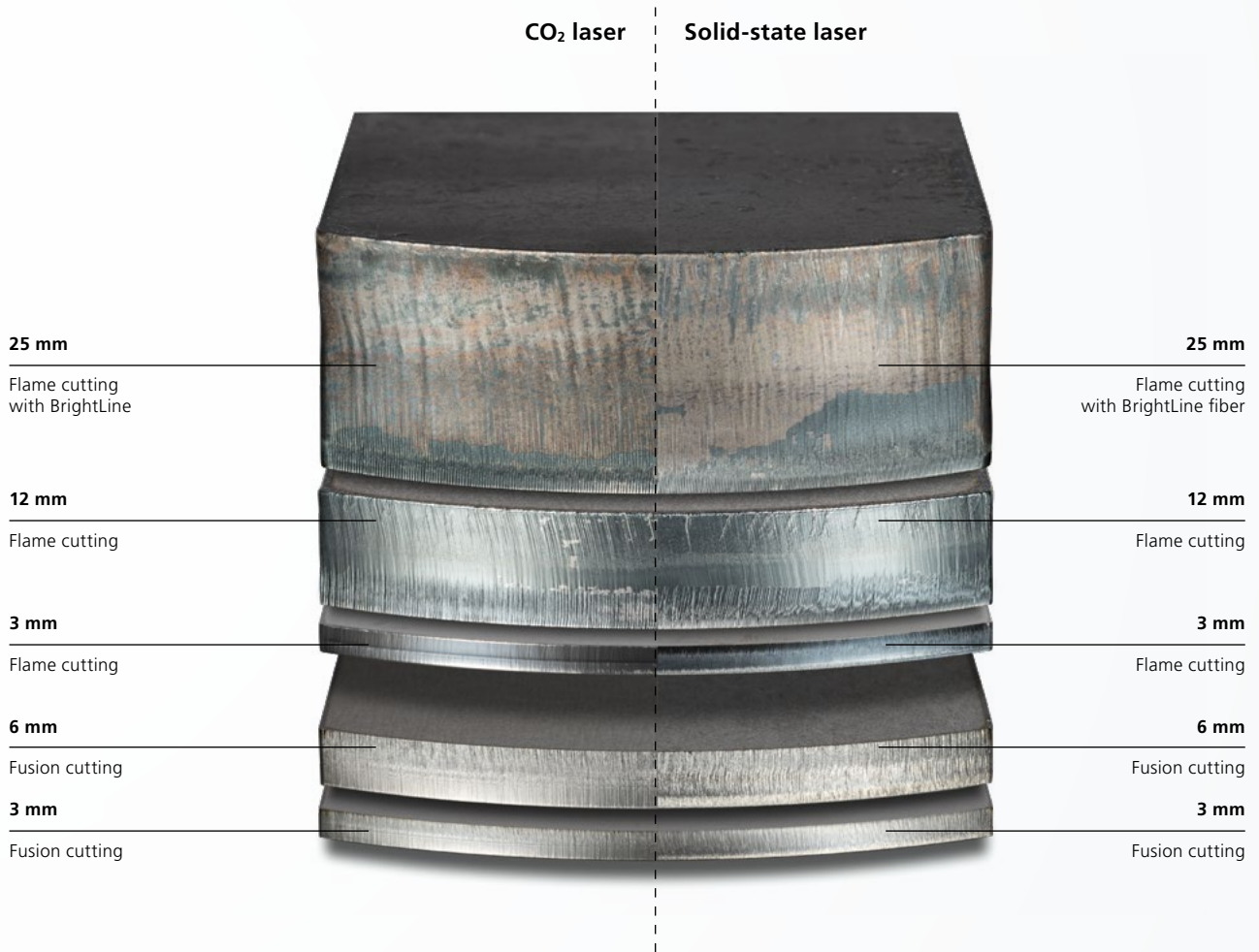

The result:



- CO₂ laser:** When carrying out flame cutting (with oxygen), both laser beam sources achieve the same level of quality. When carrying out fusion cutting (with nitrogen), the CO₂ laser outperforms the solid-state laser.
- Solid-state laser:** A slight burr forms when carrying out fusion cutting.

Please note: In these part images, the underside is shown facing upwards. This provides you with a better view of the slight burr formations.

More output with intelligent functions

Preparing

How is my machine doing?

The light on the **Condition Guide** shows you at a glance the status of important elements that affect the cutting ability of the machine; if necessary, the program provides you with recommended courses of action and generates predictions of when maintenance will be required.



Are my nozzles working properly?

If not, this can lead to burr formation, resulting in parts requiring reworking or reject parts.

Smart Nozzle Automation switches to the correct nozzle and checks the nozzle status and beam centering. This helps ensure reliability and saves you time.

Is my sheet metal positioned correctly?

This is important in particular if you wish to cut prepunched sheet metal. With **DetectLine**, a camera system precisely determines the position of inserted sheets. This function also helps to check the alignment of the focus position.

Is my lens or protective glass contaminated?

Spatter can contaminate the focusing lens of CO₂ machines. **LensLine** monitors your lens and switches off the beam if necessary. The benefit to you: Short downtimes for lens cleaning need only be scheduled when required, and you only need to replace protective glass if it is truly necessary. The **online protective glass status check** ensures that you always know the condition of the protective glass of your solid-state laser and can work with consistent quality.

How do I tackle cutting problems?

The **Cutting Guide** supports you with finding the cause for cutting problems. It offers functions for inspection in order to adjust the machine optimally.

Producing

Can I cut inferior material?

Active Speed Control monitors the cutting process in real time. In the event of sheet thickness variations or quality fluctuations such as rust or coating remnants, the system adjusts the correct feed rate on its own. Alternatively, **AdjustLine** chooses robust cutting data before the cutting process starts.

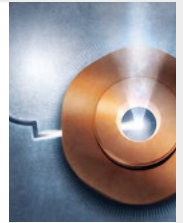

Is the focus of my laser set correctly?

Smart Beam Control checks this for you. If necessary, it adjusts the position of the focus. This saves time and ensures that the process is reliable. A further advantage of this system is that it enables remote diagnosis of the cutting system.

How can I protect my cutting head?

There is a particular danger of collision due to parts tipping over when cutting thin sheet metal. The **collision protection function** minimizes the effects of this – acting as a kind of airbag for your cutting head.

Can I cut quicker and save money at the same time?

The **Highspeed Eco** cutting turbo enables you to double your plate throughput and your feed rate, while reducing your cutting gas consumption by up to 70%. This makes nitrogen cutting with solid-state lasers extremely efficient.



What good is having the quickest machine if your parts keep tipping over? With 2D laser cutting machines, downtimes can quickly take up half of your working time. These downtimes are spent setting up your machine, sorting or rectifying faults. This is why it makes sense to shorten your entire process and permanently ensure that power is converted into output – with intelligent functions from TRUMPF.

Sorting

How can I prevent collisions?

With **Smart Collision Prevention**: Your machine manufactures parts and inside contours in a sequence that intelligently takes parts tipping over into account. This means you can carry out production reliably – without collisions or microjoints.

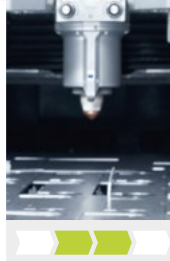

This function is also available as a test or rental version.

Neat cuts – quick removal

With **BrightLine**, your CO₂ laser can achieve the ultimate in edge quality when cutting stainless steel and structural steel. However, thanks to **BrightLine fiber**, solid-state lasers can also provide exceptionally high-quality cutting results across the entire range of sheet thicknesses and with no reduction in cutting speed. In addition, optimized, high-quality cutting gaps save time in sorting and further processing.



Starting the subsequent process

How can I identify my parts?

Consider the next process step while still carrying out cutting: the **Dot Matrix Code** ensures that you always know which part you are working on and what processes need to be carried out on it.



This function is also available as a test or rental version.

I need to reproduce a part quickly

Speed and reuse of leftover sheet metal are crucial factors here. Thanks to the camera support offered by **Drop&Cut**, you can produce parts from existing programs in seconds. This system also enables you to reuse leftover sheet metal.



Changing cutting heads takes up too much time!

Simply get rid of the process entirely: with the **one-cutting-head** strategy you can machine any sheet thicknesses with a single cutting head.



Can I also cut thick structural steel?

Yes – with **CoolLine**, even tight contours are possible. This function keeps your workpiece consistently cool during cutting. This enables you to cut even delicate parts and to nest workpieces even more tightly.

Warping at the entry point?

No, thanks! With **PierceLine** you can achieve precise entry points with minimal warping and reduce the time required to pierce the material to the absolute minimum. This increases the quality of the parts, reduces strain on your machine and lowers the time per part.

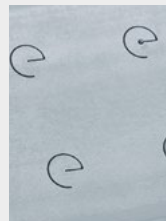

Your business, your choice



Choose the right laser machine, and use it to its full potential: In a solution that gives you the boost you need to achieve the best possible performance. Because the entire process is what matters, not just the cutting operation.



TruLaser Series 1000

01

Versatile and productive

due to the solid-state laser and cutting data
for all materials

02

Economical and cost-efficient

due to energy efficiency and minimized
setup times

Robust and cost-efficient: the machines from the TruLaser Series 1000 enable laser cutting with low investment and operating costs for the entire range of applications. They impress with their reliability and ease of operation. Due to appropriate interfaces, the machine can be automated and is ready for Industry 4.0.

**03**

Robust and reliable

with TruDisk laser and collision protection

04

Easy to operate and network

due to the touch display and Central Link

01

Versatile and productive

due to the solid-state laser and cutting data for all materials

The machine can cope with all materials and sheet thicknesses at the press of a button due to its one-cutting-head strategy. You can cut thin sheets in particular very productively with the TruDisk laser with up to 6 kW laser power. Even highly reflective materials such as copper can be cut reliably. The BrightLine fiber function enables high-quality cutting results in sheet thicknesses of up to 25 mm. The machine comes in different sizes, with up to 6 m in length.



You can even cut highly reflective materials such as copper easily and reliably with the TruLaser Series 1000.



A range of materials and sheet thicknesses with top cutting quality with BrightLine fiber.

02

Economical and cost-efficient

due to energy efficiency and minimized setup times

The machine combines low investment and operating costs with a high level of productivity. Due to the efficient TruDisk laser and coordination of the laser, machine, and units, the machine works in a very resource-saving manner. Functions such as the automatic nozzle changer, protective glass monitoring, and the pallet changer reduce your non-productive times. Due to the one-cutting-head strategy, you can also cut various types and thicknesses of material without replacing the cutting head.



Save even more time with options such as the automatic nozzle changer.

03

Robust and reliable

with TruDisk laser and collision protection

The collision protection for your cutting head allows you to produce particularly reliably. This minimizes non-productive times and makes your machine permanently productive. The TruDisk laser is insensitive to back reflections and provides stable laser power over the entire service life.

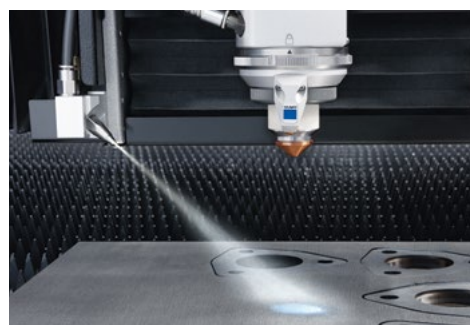

Spraying device – targeted spraying of piercing points prevents crater formation in thick steel.

Collision protection

“Even if a collision occurs, your cutting head will remain undamaged, because it deflects upon contact. In the event of minor collisions, the cutting head moves back to the starting position automatically – this provides you with exceptional reliability and safety for your production processes.”

Martin Klewenhagen, TruLaser Product Manager



04

Easy to operate and network

due to the touch display and Central Link

The menu navigation on the large touch display works intuitively. Due to the reliable, integrated cutting parameters from TRUMPF, the machine is very easy to operate. With Central Link and automation options, you can create a digital and physical network.



Generously dimensioned and easy to operate – the touch display of the TruLaser Series 1000.



Everything at a glance with the mobile display of the control panel.

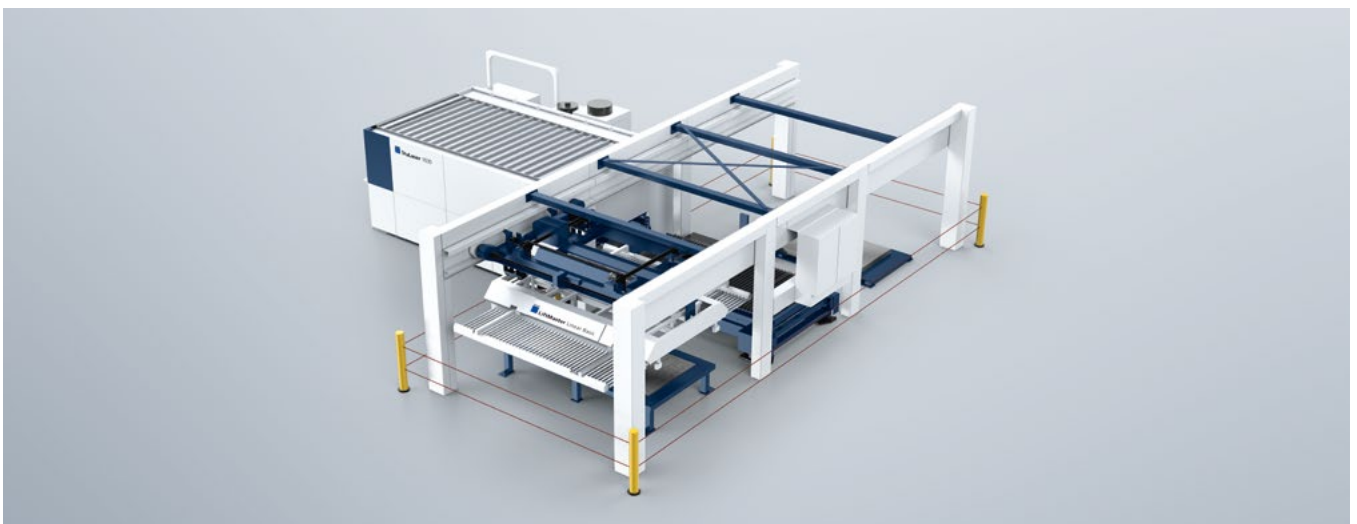

The LiftMaster Linear Basic loads and unloads your machine fully automatically.

TruLaser Series 2000



01

Compact and flexible set-up

thanks to low space requirements

02

Productive cutting

with reduced nonproductive time

03

Intuitive operation

with touch control

The compact TruLaser Series 2000 laser cutting machines combine minimum space requirements and ease of operation with high performance.



04

Top cutting edges

due to BrightLine fiber

05

Cost-effective growth

with the LaserNetwork

01

Compact and flexible set-up

thanks to low space requirements

If you are looking for a high-power product in a compact format, with its flexible layout and compact design, this laser cutting machine is tailor-made for you: simply select the setup variant that suits your requirements.



The compact design of the TruLaser 2030 fiber machine saves space. Its layout makes it extremely flexible and easily adaptable.

03

Intuitive operation

with touch control

Thanks to the intuitive design of the control panel, you have easy access to all of the functions of your machine: The 19" touch display offers ideal working conditions for the operator. It also provides an excellent overview of the entire working area and all processes – with complete safety.



The touch display makes work pleasant for the operator.

02

Productive cutting

with reduced nonproductive time

The TruLaser Series 2000 combines the advantages of a compact machine with the power of higher machine classes: With the TruDisk disk laser, you can cut highly productively and reliably in the long term. It is also possible to cut nonferrous metals due to its insensitivity to back reflections. Depending on the power you need, choose the TruDisk Laser 2001, 3001 or 4001, with 2, 3 or 4 kW respectively.



Well protected, even in the event of collisions, due to tilted parts, as a result of collision protection.



Replacing cutting nozzles by hand is a thing of the past: with the automatic nozzle changer, your machine can perform this task in a fraction of the time.

04

Top cutting edges

due to BrightLine fiber

You can even create high-quality cutting edges in thick sheet with the BrightLine fiber function. The optimized kerf makes part removal easier and saves time.



Win over your customers with thick sheet and cutting edges that shine.

Insensitive to back reflections

“With our robust TruDisk laser, we can even cut reflecting materials such as copper reliably.”

Jim Mozdierz, R&D testing engineer

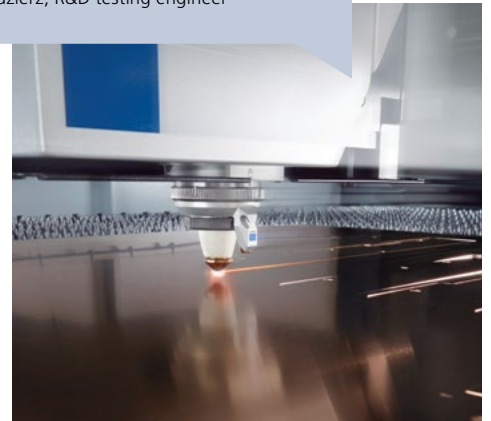

05

Cost-effective growth

with the LaserNetwork

If you wish, your TruLaser 2030 fiber can open the door to other manufacturing processes for you. For example, it can make it much easier to get started with laser welding, as you can use your TruDisk as a beam source for other machines in a laser network. This feature even makes it possible to switch between applications every hour or every shift.



Your TruDisk can supply multiple machines in the LaserNetwork if required. This enables you to get started with laser welding, for example.

TruLaser Series 3000



01

Limitless flexibility

in terms of format, power and options

02

High-quality results

in all sheet thicknesses

The machines of the TruLaser Series 3000 are true all-rounders in laser cutting, and are extremely flexible and reliable.



03

Go full throttle

while saving cutting gas

04

Versatile automation

for an uninterrupted process chain

01

Limitless flexibility

in terms of format, power and options

You can completely customize the layout of your machine to suit your needs: You can choose between large format (3 x 1.5 m), max-format (4 x 2 m) or even oversize format (6 x 2.5 m). A transverse setup is also possible. You can likewise choose the laser power: 3, 4, 6 or 8 kW. With the RotoLas option, you can even process pipes directly on your 2D laser machine. When equipped with the multisheet processing function, your 2D laser machine can automatically cut multiple sheets one after the other on a single pallet.



RotoLas enables you to add pipes and profiles to the range of parts you can produce.

03

Go full throttle

while saving cutting gas

Using the Highspeed method, you can carry out nitrogen cutting with the solid-state laser in record time: This method enables you to nearly double your feed rate and sheet throughput when processing medium and thick structural steel and stainless steel sheets. The new nozzle design reduces your cutting gas consumption by up to 40% and even prevents burr formation on contours with sharp edges. And if that's not enough, with Highspeed Eco you reduce cutting gas consumption by up to 70%.

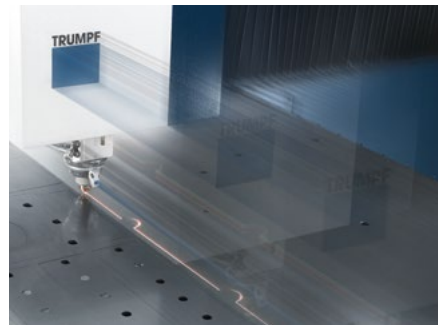

Go full throttle and save gas: With Highspeed, your cutting gas requirements are reduced by up to 40%, while your sheet throughput is increased by up to 100%.

02

High-quality results

in all sheet thicknesses

BrightLine fiber turns your solid-state laser into a universal tool: This function provides high-quality cutting results in all sheet thicknesses, while still enabling you to enjoy all of the benefits of thin sheet processing with a solid-state laser, most notably high cutting speeds.

BrightLine makes the cutting pattern of your CO₂ laser perfect: Special cutting data and the BrightLine nozzle significantly improve the quality of your cut edges, particularly when processing thick stainless steel. BrightLine fusion cutting helps you to achieve edges you can see your reflection in – with no need for any reworking.



With BrightLine fiber, you can cut a wide variety of materials and sheet thicknesses with the best possible quality.

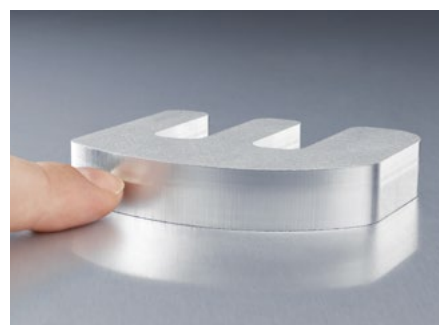

BrightLine enables maximum cutting quality. The characteristic feature of this function is the mirror edges.



Smart Collision Prevention

“Parts tipping over? Smart Collision Prevention takes them into account. As a result, this function reduces the risk of collisions to a minimum.”

Patrick Mach, Development, Laser Cutting

04

Versatile automation

for an uninterrupted process chain

With the right automation solution, you can optimize your process chain for specific requirements: Select the required components from a large modular system. From simple loading through to fully automated loading and unloading including part separation and storage connection, everything is now possible with the TruLaser Series 3000.



A strong team: LiftMaster Compact automatically loads and unloads your machine. With the PartMaster, you can manually remove finished parts and grid residue from the transport belt with ease while production is in progress. More information on the topic of automation is available on pages 36 and 37.

TruLaser Series 5000



01

Maximum dynamics

even with complex contours

02

Producing with process reliability

even in fully automated operation

03

Extremely fast

with Highspeed Eco

The high-power products in the TruLaser Series 5000 set new standards for productivity and cost-effectiveness.



05

Semi-autonomous laser cutting
with Active Speed Control

04

Top part quality
thanks to BrightLine fiber

01

Maximum dynamics

even with complex contours

The productive machines in the TruLaser Series 5000 can effortlessly handle both thin and thick sheets. With the TruDisk 10001 and highly dynamic drives, they enable highly productive and reliable manufacturing across the entire range of sheet thicknesses. The machines in this range are designed for maximum capacity and are able to convert these high feed rates into sheet throughput.

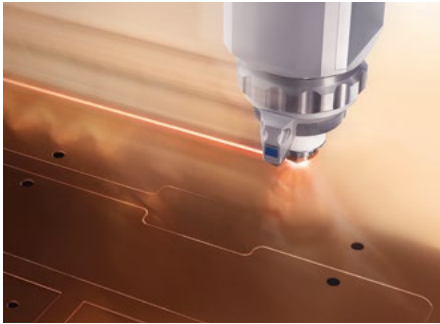

With the 10 kW TruDisk 10001 laser, you can process a wide range of materials in the best possible quality with even higher productivity.

02

Producing with process reliability

even in fully automated operation

Ensuring that the nozzle and lens are in the best possible condition is an important prerequisite for achieving reliable processes and high part quality. Smart Nozzle Automation combines intelligent functions that ensure just that – even in fully automatic operation. With the CoolLine function, you can perform delicate cutting operations, even in thick structural steel. This function cools the workpiece during cutting and enables new geometries, more efficient sheet configuration, and reliable processing of thick structural steel.



Smart Nozzle Automation ensures that the nozzle and lens are kept in the best possible condition.

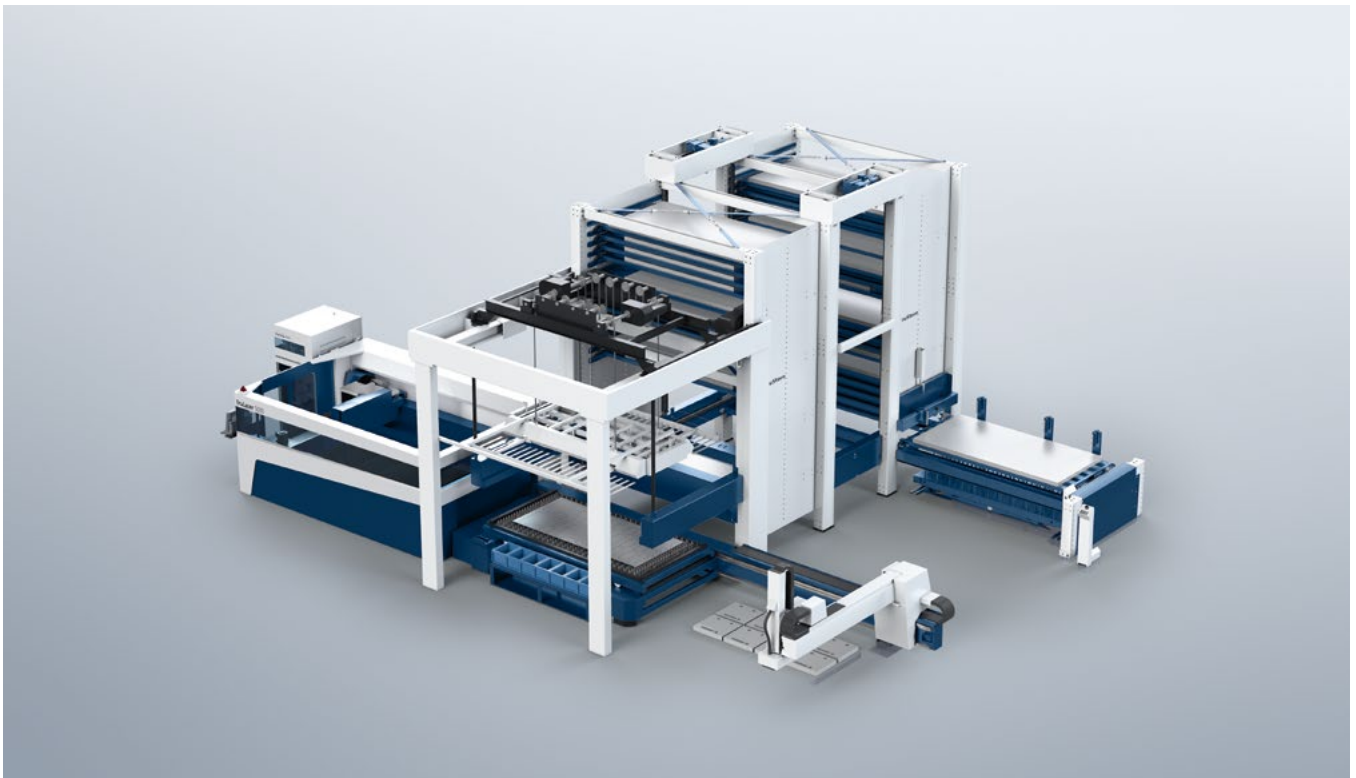

LiftMaster Store connects the TruLaser 5030 directly to a TruStore 3030 and a SortMaster. More information on the topic of automation is available on pages 40 and 41.

Condition Guide

“How is your machine doing? You can find out at a glance: the light in the Condition Guide shows the status of important elements that could affect the cutting ability of the machine.”

Andreas Vollmer, TruLaser technology expert from the demonstration center

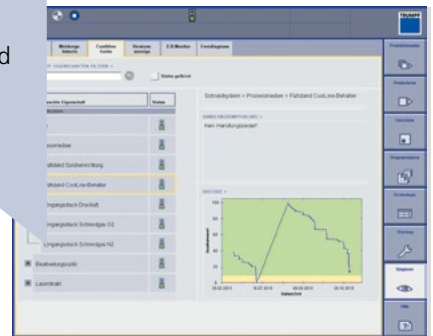

03

Extremely fast

with Highspeed Eco

The Highspeed Eco cutting process enables you to get even better performance from your laser machine. When carrying out nitrogen cutting, this method enables you to nearly double your feed rate and sheet throughput when processing medium and thick structural steel and stainless steel sheets, without any reduction in quality: Highspeed Eco even prevents burr formation on contours with sharp edges. Due to the patented nozzle design, you save up to 70% of cutting gas.



Highspeed Eco: Up to 100% higher productivity and up to 70% lower cutting gas consumption.

04

Top part quality

thanks to BrightLine fiber

BrightLine fiber combines special optics with flow-optimized BrightLine nozzles and the switchable 2-in-1 cable. The result of this is that you achieve maximum part quality. The smooth cutting edges ensure that your parts do not get caught during removal, saving you a great deal of time.



Simple parts removal included: BrightLine fiber.

05

Semi-autonomous laser cutting

with Active Speed Control

Another milestone on the way to the autonomous machine: Active Speed Control. The system sees through the nozzle into the kerf, monitors the cutting process, and regulates the feed rate on its own. Even in the event of thickness variations in a sheet, or if the sheet has been affected by quality fluctuations such as rust or coating remnants, the system ensures the right feed rate for flame and fusion cutting. Cutting disruptions are prevented which reduces the amount of reject parts significantly.

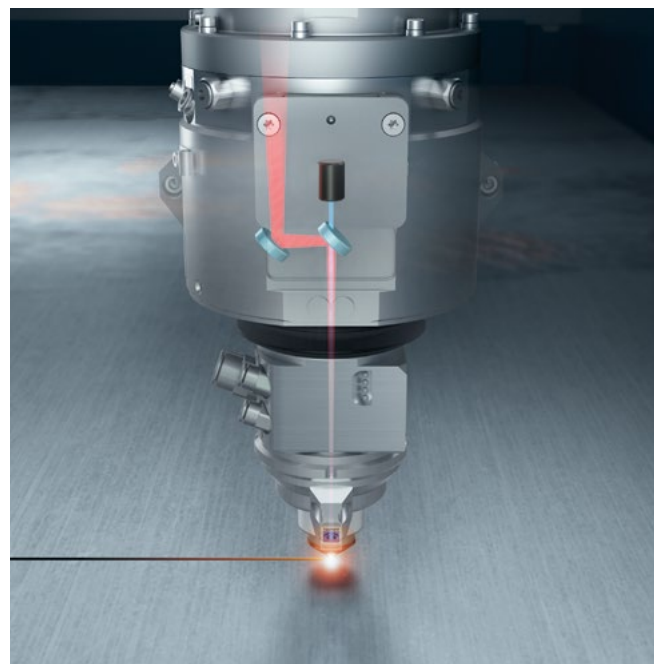

Active Speed Control, the adaptive feed rate regulation, increases process reliability and relieves operators.

TruLaser Series 8000

01

Cut oversize formats

up to 16 m in length

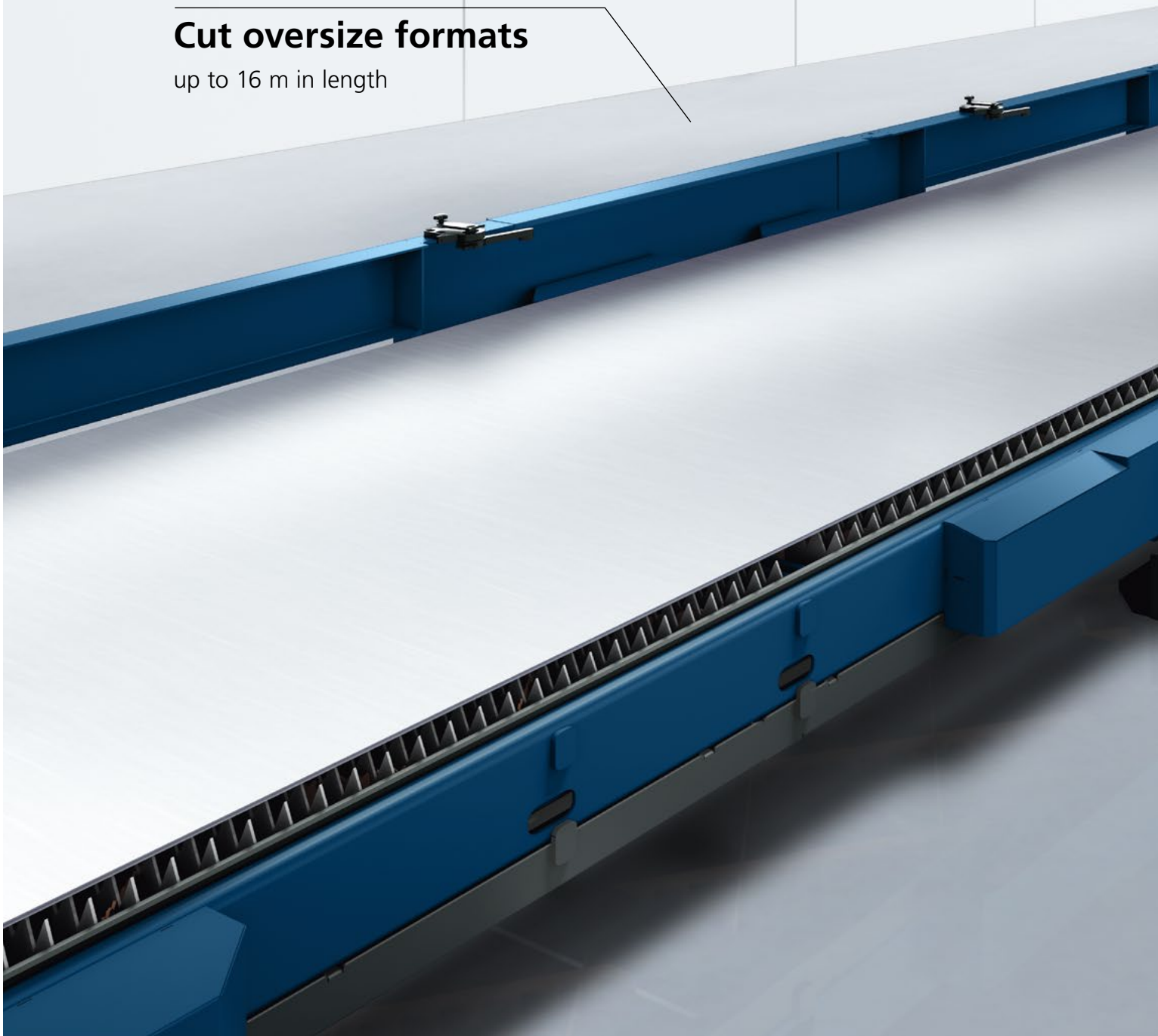

The flexible laser machines in the TruLaser Series 8000 guarantee you maximum cost-effectiveness and excellent part quality in processing oversize formats.



04

Variable pallet concept

adjusts to meet your needs

03

Double your productivity

with two cutting heads

02

No misalignment when cutting

with sheet cycling

01

Cut oversize formats

up to 16 m in length

Break through into new dimensions: With the TruLaser Series 8000 you can process sheets up to 16 m x 2.5 m in size. These machines also offer all the benefits of a machine for standard sheets, particularly in terms of flexibility. For sheets of up to 16 m in length, you can use the unique additional pallet concept, which provides the right solution for every application area through the combination of a 4-m pallet changer with an oversize pallet.

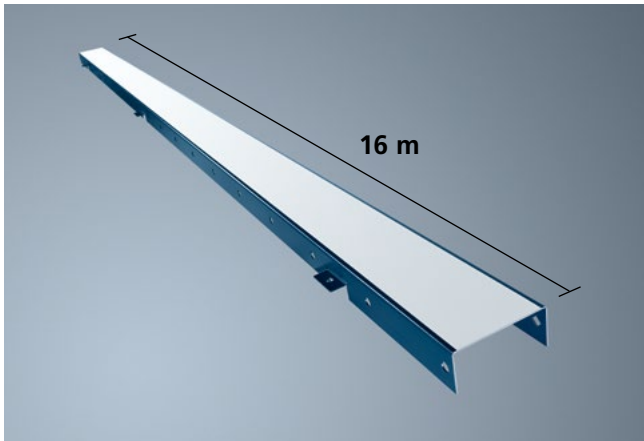

Chamfered profile in oversize format, cut on a TruLaser Series 8000.

02

No misalignment when cutting

with sheet cycling

Sheets up to 16 m in length are moved through the 4 m long and 2.5 m wide working area of the machine in several steps. A rigid machine frame, high-precision measurement systems, and linear drives on all axes ensure you have the best part quality and perfectly aligned cutting results.

03

Double your productivity

with two cutting heads

You can achieve maximum productivity with two cutting heads working simultaneously – productivity increases of up to 100% are possible. With this concept, each cutting head of your CO₂ machine is supplied by a separate TruFlow laser and can be switched on and off independently.



TruLaser 8000 and TruBend 8000: Laser cutting and bending of oversize format parts.

CoolLine

“One cool thing: With the smart CoolLine functions you can cut delicate contours, even in thick structural steel.”

Benedikt Braig, TruLaser Product Manager



04

Variable pallet concept

adjusts to meet your needs

Various options are available for the pallet concept, tailored to your proportion of oversize formats: Select the oversize format additional pallet for high productivity in standard formats and maximum flexibility for oversize format sheets up to 16 m in length. Or select the oversize format pallet changer, which provides you with maximum productivity with oversize formats up to 12 m in length thanks to loading and unloading while production is in progress.

Perfect for an oversize format proportion **of up to approx. 40%:**

For standard formats of up to 4 m in length, use the pallet changer (1) and automation for the highest level of productivity. You can increase your flexibility by using the additional pallet (2) for sheets up to 16 m in length.

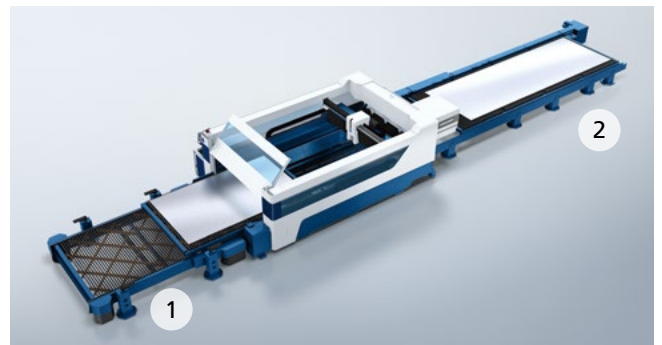

Flexibility provided by the additional pallet for oversized sheets.

Perfect for an oversize format proportion **from approx. 40%:**

Achieve maximum productivity with oversized sheets of up to 12 m in length through loading and unloading parallel to production. With the fast oversize format pallet changer, you can achieve the shortest cycle times. You can also produce cost-effectively in unattended operation with the maximum process reliability.

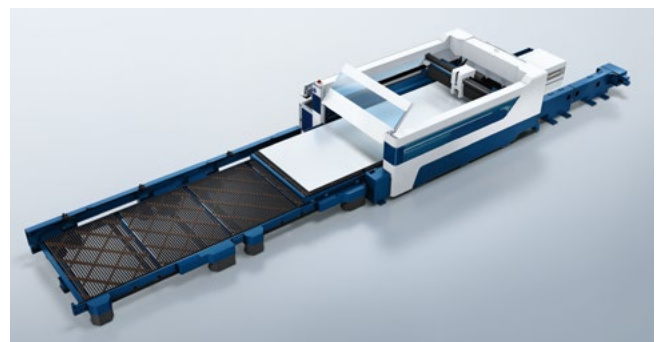

A high level of productivity provided by the oversize format pallet changer.

Technical data

We have summarized the technical data for the TruLaser machines for you on these pages.

Technical data								
		TruLaser 1030 fiber	TruLaser 1040 fiber	TruLaser 1060 fiber	TruLaser 2030 fiber	TruLaser 3030	TruLaser 3040	TruLaser 3030 fiber
Maximum format size that can be processed								
X-axis	mm	3000	4000	6000	3000	3000	4000	3000
Y-axis	mm	1500	2000	2000	1500	1500	2000	1500
Z-axis	mm	115	115	115	75	115	115	115
Workpiece								
Max. weight (up to 6 kW)	kg	1100	2000	3000	900	900	1700	1100
Max. weight (8 kW and higher) ²⁾	kg	–	–	–	–	–	–	1800
Max. speed								
Simultaneous	m/min	140	140	140	140	140	140	170
Accuracy¹⁾								
Positioning deviation P _a	mm	0.05	0.05	0.05	0.1	0.05	0.05	0.05
Average positioning scatter band P _{s max}	mm	0.03	0.03	0.03	0.03	0.03	0.03	0.03
Cycling repeat accuracy		–	–	–	–	–	–	–
Positioning accuracy		–	–	–	–	–	–	–
Available lasers		TruDisk 2001/3001/ 4001/6001	TruDisk 2001/3001/ 4001/6001	TruDisk 2001/3001/ 4001/6001	TruDisk 2001/3001/ 4001	TruFlow 3200/4000/ 5000/6000	TruFlow 3200/4000/ 5000/6000	TruDisk 3001/4001/ 6001/8001

Laser data										
		TruLaser Series 1000 fiber				TruLaser Series 2000 fiber			TruLaser Series 3000/5000	
		TruDisk 2001	TruDisk 3001	TruDisk 4001	TruDisk 6001	TruDisk 2001	TruDisk 3001	TruDisk 4001	TruFlow 3200	TruFlow 4000
Max. power	W	2000	3000	4000	6000	2000	3000	4000	3200	4000
Wavelength	µm	1.03	1.03	1.03	1.03	1.03	1.03	1.03	10.6	10.6
Max. sheet thickness										
Structural steel	mm	16	20	25	25	15	20	20 / 25 ³⁾	20	20
Stainless steel	mm	8	15	20	25	8	15	20	12	15
Aluminum	mm	2	15	20	25	6	12	15 / 20 ³⁾	8	10
Copper	mm	1.5	6	8	10	3	6	8	–	–
Brass	mm	1.3	6	8	10	3	6	8	–	–
Power consumption										
Average power consumption during production	kW	12	13	14	18	12	13	14	29	31

¹⁾ The positioning accuracy data relates to the entire working length. The positioning accuracy is recorded in a production plant in accordance with VDI/DGQ 3441.

²⁾ Data relates to a single pallet. When loading several pallets, different values apply. ³⁾ With BrightLine fiber. ⁴⁾ 30 mm for the TruLaser Series 3000 fiber; 40 mm for the TruLaser Series 5000 fiber. ⁵⁾ For TruLaser Series 5000.

TruLaser 3040 fiber	TruLaser 3060 fiber	TruLaser 5030	TruLaser 5040	TruLaser 5060	TruLaser 5030 fiber	TruLaser 5040 fiber	TruLaser 5060 fiber	TruLaser 8000
4000	6000	3000	4000	6000	3000	4000	6000	16000
2000	2500	1500	2000	2000	1500	2000	2000	2500
115	115	115	115	115	115	115	115	105
2000	3000	1800	3200	4800	1100	2000	3000	Depending on the selected pallet concept
3300	4900	-	-	-	1800	3300	4900	
170	170	300	300	300	283	283	283	304
0.05	0.05	0.05	0.05	0.05	0.05	0.05	0.05	0.05
0.03	0.03	0.03	0.03	0.03	0.03	0.03	0.03	0.03
-	-	-	-	-	-	-	-	± 0.1
-	-	-	-	-	-	-	-	± 0.2
TruDisk 3001/4001/6001/8001	TruDisk 3001/4001/6001/8001	TruFlow 6000	TruFlow 6000	TruFlow 6000	TruDisk 4001/6001/8001/10001	TruDisk 4001/6001/8001/10001	TruDisk 4001/6001/8001/10001	TruFlow 4000/6000

TruLaser Series 3000/5000		TruLaser Series 3000 fiber	TruLaser Series 3000/5000 fiber				TruLaser Series 5000 fiber	TruLaser Series 8000	
TruFlow 5000	TruFlow 6000	TruDisk 3001	TruDisk 4001	TruDisk 6001	TruDisk 8001	TruDisk 10001	TruFlow 4000	TruFlow 6000	
5000	6000	3000	4000	6000	8000	10000	4000	6000	
10.6	10.6	1.03	1.03	1.03	1.03	1.03	10.6	10.6	
25	25	20	25	25	25	30	20	25	
20	25	15	20	25	40 ⁴⁾	40	15	25	
12	15	15	20	25	25	25	10	15	
-	-	6	8	10	10	16	-	-	
-	-	6	8	10	10	12	-	-	
35	38/32 ⁵⁾	13	14	18	20	25	31	38	

Intelligent functions

Which intelligent functions are available to you with which machine series?
This table provides you with a simple overview.

Laser				
	TruLaser Series 1000 Solid-state	TruLaser Series 2000 Solid-state	TruLaser Series 3000 CO ₂	TruLaser Series 3000 Solid-state
Active Speed Control				
AdjustLine	■		■	■
BrightLine			■	
BrightLine fiber	■	■		■
Cutting Guide	■		■	■
Condition Guide	■		■	■
CoolLine			■	■
DetectLine	■		■	■
Dot Matrix Code	■		■	■
Drop & Cut	■		■	■
One-cutting-head strategy	■	■	■	■
Hightspeed				■
Hightspeed Eco				■
Collision protection	■	■	■	■
LensLine			■	
Online condition checking, protective glass	■			■
PierceLine	■	■	■	■
Smart Beam Control				
Smart Collision Prevention			■	■
Smart Nozzle Automation				



TruLaser Series 5000



TruLaser Series 8000

TruLaser Series 5000		TruLaser Series 8000
CO ₂	Solid-state	CO ₂
	■	
■	■	■
■		■
	■	
■	■	■
■	■	
■	■	■
■	■	
■	■	■
■	■	■
■	■	■
	■	
	■	
■	■	■
■		■
	■	
■	■	■
	■	
■	■	
■	■	

Automation is worth it

Automated, your TruLaser cutting machine works even more productively. Select from a large assembly kit of modular automation components. This provides you with a solution tailored precisely to your needs, ranging from semiautomatic loading through to a fully automated machine with a storage connection.



Automation functions

Loading

Loading and unloading

Combinable machines

LoadMaster



LiftMaster Compact



LiftMaster Linear Basic



TruLaser Series 1000

TruLaser Series 2000

TruLaser Series 3000

TruLaser Series 5000

TruLaser Series 8000



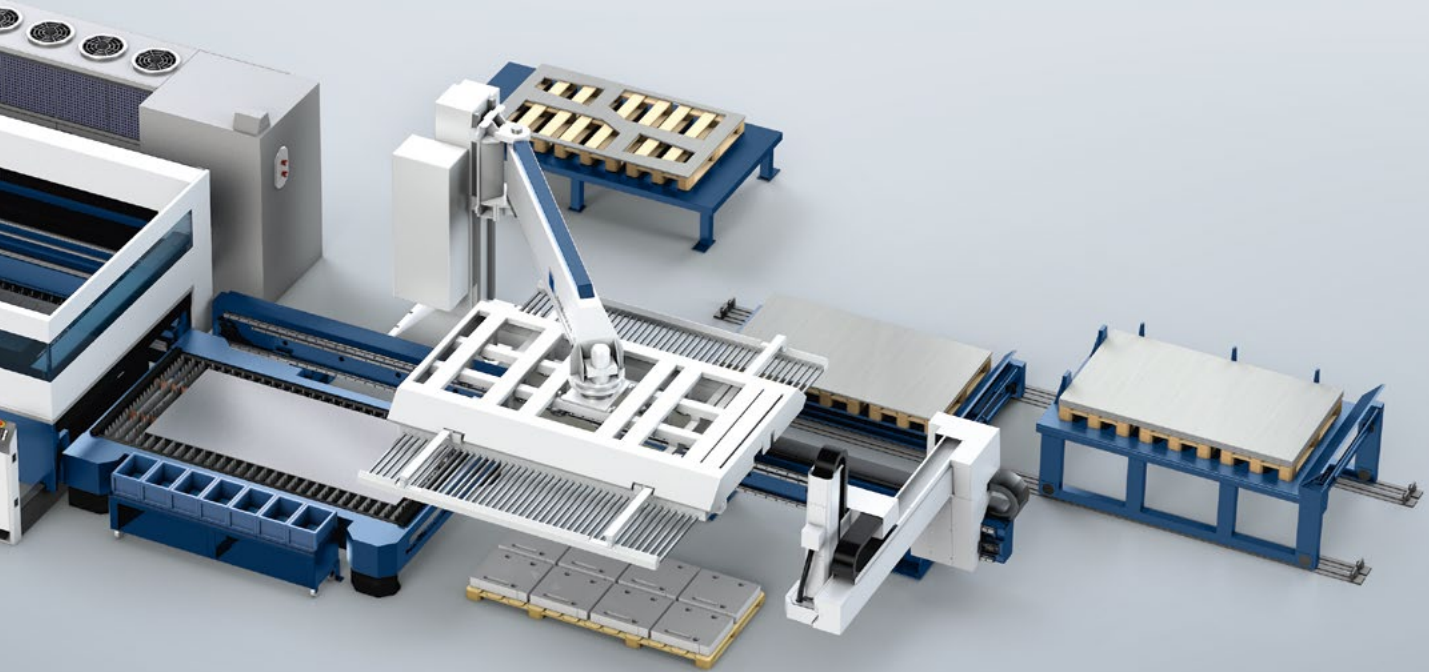







Regardless of the extent to which you wish to automate your processes: you can find the right solution for your production processes on our website and in the automation catalog: www.trumpf.info/zqi2wh

Loading and unloading/part sorting

Auxiliary pallet operation

Storage system operation

LiftMaster	LiftMaster Linear	LiftMaster Store LiftMaster Store Linear	SortMaster	PalletMaster Tower	TruStore
					
■	■	■			■
■	■	■	■	■	■
■	■	■	■	■	■
■					■

TruLaser Center 7030

The first full-service laser machine. Takes care of everything – from drawings to sorted parts.

Thinking outside the box

We have fundamentally questioned the entire process of laser processing. The result? A groundbreaking machine concept combining productivity and process reliability.

Hitting the ground running

Unlike conventional 2D laser machines, the TruLaser Center 7030 moves the sheet as well as the cutting head. With the additional axis on the cutting head, this machine achieves peak values in terms of cutting dynamics. The result of this are overlapping axis movements that make your machine extremely powerful. Equipped with a laser power of 6000 W, this enables you to cut through sheets with a thickness of up to 12.7 mm in a highly dynamic manner.

Intelligent automation

This fully automatic machine guarantees reliable part handling thanks to in-built intelligence with automation solutions such as SmartGate, SmartLift and SortMaster Speed. This eliminates the possibility of workpieces tipping over or tilting and the need to use microjoints.

Producing around the clock

Connect the TruLaser Center 7030 to your store and profit from a higher machine utilization rate because of the optimized material flow and lower material access time. The machine takes care of bothersome and monotonous work steps for you around the clock – this saves manpower and relieves the strain on employees.



Quick Reliable Intelligent

Independent



Short film: Simple explanation

Waiting until parts and grid residue are sorted out of the pallet? Downtimes due to parts tipping over? Reworking? With this fully automatic machine these typical challenges are a thing of the past. www.trumpf.info/gabuym



A comparison of the process steps



The result: the TruLaser Center 7030 takes care of all processes involving laser cutting safely and reliably – reducing your processing costs considerably.

Depending on the country, the available product range and data may differ from the details listed here. The technology, equipment, price and available accessories are subject to change. Please contact your local contact person to find out whether this product is available in your country.

Working in perfect harmony for your success

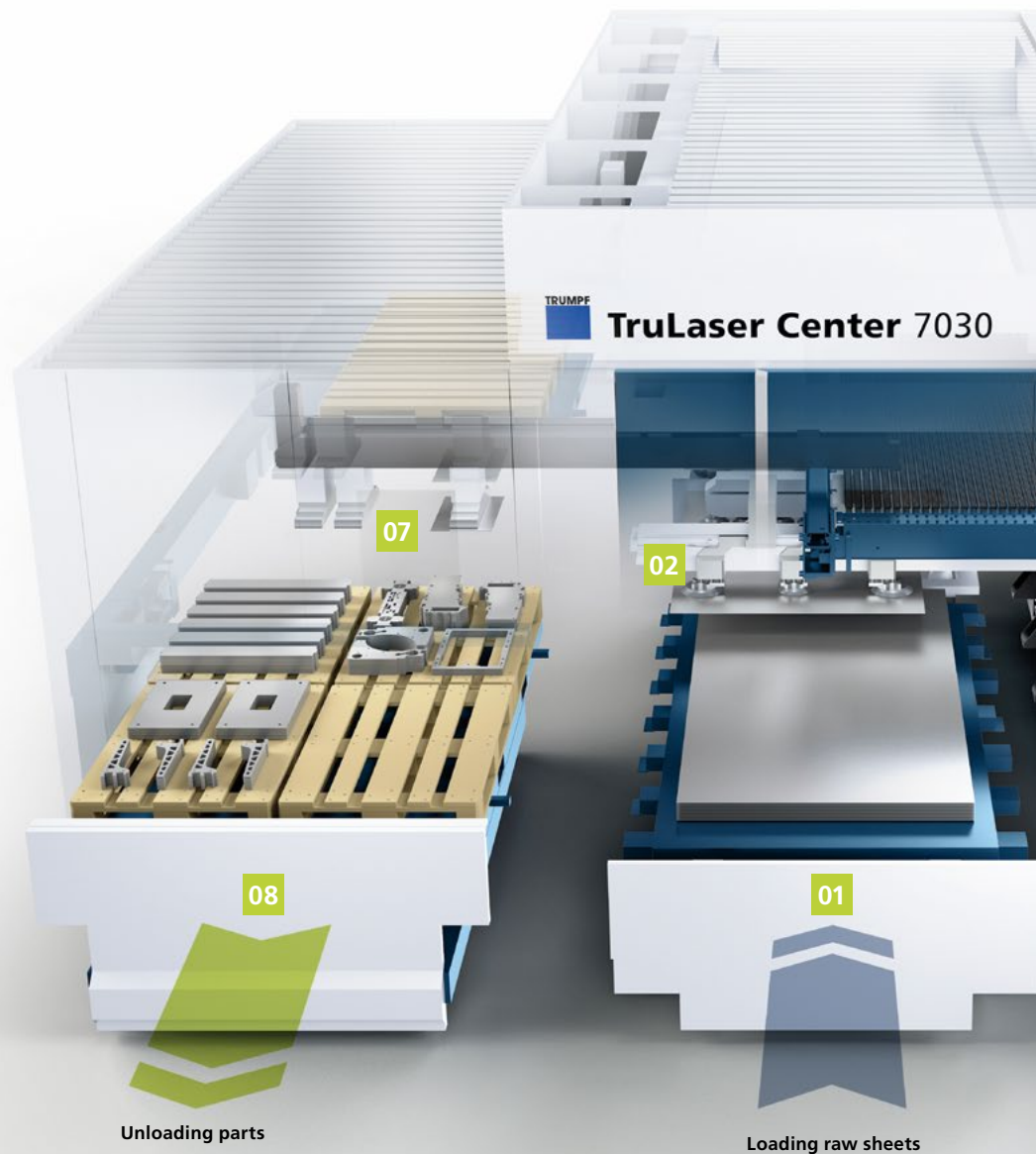

Programming an order

At the press of a button, the TruTops Boost programming system performs a fully automatic calculation for a comprehensive proposal for the cutting, removal, sorting, and depositing of your parts.

Loading raw sheets

The loading cart **(01)** can be loaded parallel to production. The LoadMaster Center **(02)** places the raw sheet on the brush table in the clamping unit. High-performance peeling techniques separate the sheet reliably from the stack.

Cutting parts

The clamping unit moves the sheet in the Y direction, the cutting unit **(03)** processes it in the X direction and also in the Y direction using a highly dynamic additional axis. The SmartGate supports the cutting process.

Anyone who wants to manufacture using laser cutting in an economical way, needs a machine in which all steps are interlinked. This is where the TruLaser Center 7030 scores with the close interaction between integrated intelligence and new automation solutions.



Unloading scrap skeletons

Removing parts and scrap

The intelligent SmartGate **(04)** removes slugs, scrap, and small parts reliably. The sorting flap separates finished cut parts from scrap. Finished parts are sorted into eight containers **(05)**. Scrap and slugs fall into a slag cart **(06)**.

Unloading parts onto stacks

The SmartLift uses its pins to push the parts out of the scrap skeleton. The finely structured suction plates of the SortMaster Speed **(07)** remove the cut parts, and sort and stack them on the parts deposit. The suction plates and pins prevent any tilting of the parts.

Unloading finished parts and scrap skeletons

The parts **(08)** are removed from the machine, sorted, and stacked parallel to production. The clamping unit unloads the scrap skeleton onto the sheet skeleton cart **(09)**. A forklift truck can empty this unrushed while the machine is operating.



See for yourself:
This is how the TruLaser Center 7030 works:
www.trumpf.info/xvnp0u



TruConnect. Your Smart Factory



80%

Indirect processes make up 80% of your production time – this represents the greatest potential for savings.



Discover the potential networked production could unlock for you with these two example scenarios:
www.trumpf.com/s/smart-factory





Networking brings considerable freedom: You see more, know more, and are able to use your production facility to its full potential. With TruConnect, TRUMPF's synonym for Industry 4.0, you can develop your own Smart Factory step by step. TRUMPF solutions take you along the way to networked production, and help you to make your overall process more transparent, more flexible and especially more profitable.

For companies of all sizes: from simple production solutions to an entirely interconnected facility

- **Getting started** with machines that are fundamentally equipped for networks.
- **Gradually changing** with automated machines or autonomous processing cells embedded in a production solution.
- **Networking everything** with a continuous production solution going from the incoming order to dispatch.

Smart functions and Industry 4.0

With the MobileControl app you can operate and monitor your machine easily and flexibly: It transfers the standard control panel interface to the touchscreen of your tablet. Thanks to the Central Link interface, your TruLaser machine is ready for Industry 4.0.



Lines marked with Dot Matrix Code simplify your processes.



You can monitor and control your machine in the machine environment with the MobileControl app.



You can find more information about networked production here:
www.trumpf.com/smart-factory

TruServices. Your Partner in Performance

To secure your future success, capitalize on services that will move you forward not just short-term but in the long run too: Whether you want to create the best conditions for successful manufacturing, make the most of your TRUMPF laser systems, or have the flexibility to adapt them to changing requirements – together we will find opportunities to maximize your value creation long-term. We will provide you with all-round support as a reliable partner with solutions and service packages for your needs – enabling you to manufacture economically and at a constantly high level.



Comprehensive training program

EMPOWER: When you would like to create optimal conditions for production success: We will help you in that. Take advantage of our comprehensive training program, to deepen your knowledge and ensure competitive advantages. In the laser cutting technology course, you learn, for example, how to achieve the best cutting quality possible and how to determine the piercing parameters for special materials.



Water reconditioning with the Easy Filter

SUPPORT: If flexibility and system availability are essential to your operation: We are here for you. Save time and money. With the Easy Filter, you can do one cooling circuit service a year quickly and easily without ever needing to change the cooling water.



The Highspeed Eco cutting system

IMPROVE: If you want to gradually focus your manufacturing on maximum value creation: We will work together to reach your goal. With Highspeed Eco, for instance, you can double your throughput for laser cutting – the surface-mounted nozzle also reduces cutting gas consumption by up to 70%.



Financing

Training

Pre-owned machines

Technical Service

Tools

Genuine parts

Design and programming software

Process optimization

Monitoring & analysis

Product enhancements

Value packages

Service agreements



You can learn more about our complete and comprehensive package of useful services here: www.trumpf.com/s/services



Your suitable total package

From the machine to the optical system through to the technology data: At TRUMPF, we develop our products ourselves. Our sales representatives are product experts with many years of experience. Our developers have thought through every function deeply and in detail. This makes TRUMPF laser cutting machines the basis of your success.



You receive a coordinated production system that is always available.

TruServices

With comprehensive services and a global service network, we are always there for you.

Software

You optimize your production processes with software solutions from TRUMPF. The TruTops Boost programming system is perfectly adapted to your TruLaser machine.

Automation

There is a large range of modular automation components available for your TruLaser machine.

Process expertise

Every machine includes up-to-date technology data for laser cutting checked by TRUMPF – this enables you to get started easily.

Optical system

We develop lasers, fiber optic laser cables, and cutting heads for each specific set of requirements and for every series. The benefit to you: you can make the best possible use of the power of your tool.

Machine

All TruLaser machines are developed and produced at TRUMPF – they provide you with a robust solution for your day-to-day industrial operations.

The passion that drives us

From production and manufacturing technology to laser systems and material processing, we develop highly innovative products and services to meet your needs. Our solutions are superbly reliable and ready for industrial use. We do everything we can to give you a powerful competitive edge, drawing on our expertise, experience, and a genuine passion for what we do.



Visit our YouTube channel:
www.youtube.com/TRUMPFtube



Lasers for manufacturing technology

Whether macro, micro or nano: We have the right laser and the right technology for any industrial application, allowing you to manufacture in an innovative yet cost-efficient manner. As well as the technology, we will also support you with system solutions, knowledge of applications, and advice.



Power-supply systems for high-tech processes

From semiconductor production to manufacturing solar cells: Our high- and medium-frequency generators give electricity for induction heating, plasma and laser excitation a defined form based on frequency and demand – highly reliable and for repeat accuracy.



Machine tools for flexible sheet metal and pipe work

Laser cutting, punching, bending, laser welding: For all processes in flexible sheet production, we offer you custom-fit machines and automation solutions, including consultancy, software, and services – enabling you to produce your products reliably and in high quality.

Industry 4.0

The TruConnect range of solutions connects man and machine through information. It covers all steps of the production process – from offer to shipping your parts.



TRUMPF is certified to ISO 9001
(Find out more: www.trumpf.com/s/quality)

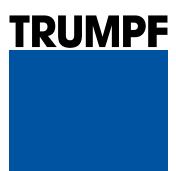

TRUMPF Werkzeugmaschinen GmbH + Co. KG
www.trumpf.com