

DCAT product series

Dynamic contact angle measuring device and tensiometer

From entry level device to high performance measuring system for single fibres

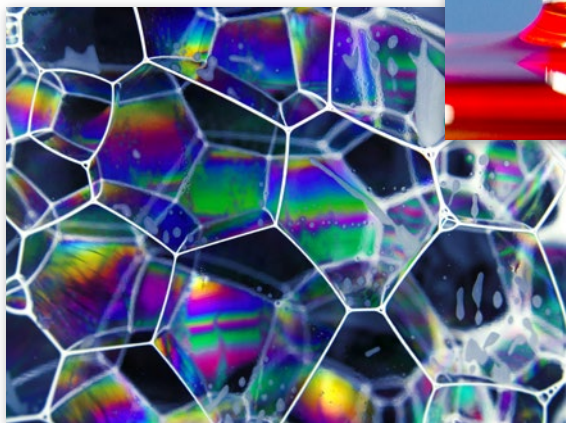

Tensiometry – an introduction

Surface and interfacial tension

Surface tension acts to contract and minimise any liquid surface. If a surface is being enlarged by the formation of a liquid lamella, as a test body, such as a **Wilhelmy plate** or **Du Noüy ring**, is in contact with it, the surface tension exerts a tensile force that can be measured. Within a **tensiometer** this force is measured by a high precision weighing system and, hence, the **surface tension of the liquid** can be calculated.



Du Noüy ring with liquid lamella

Using a tensiometer, also the **interfacial tension** between two liquids can be measured with the help of a test body. Since tensiometry is based on force measurements it is – in contrast to the optical analysis of pendant drops – not necessary that one of the liquids is transparent or that the refractive index differs between the two liquids. Therefore, tensiometry is in many cases a handy alternative to the optical measurement of surface and interfacial tensions.

Wetting phenomena

With tensiometry it is also possible to investigate the wetting of and **dynamic contact angles** on solid samples that are used as the test body. For this purpose the sample is dipped into a liquid with known surface tension and pulled back out again. In this case the weighing system detects

Wilhelmy plate

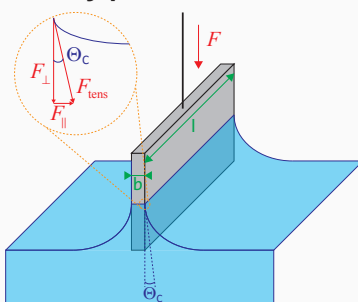

Surfactants and CMC

Interfacially active compounds like **surfactants** consist of a hydrophilic and a hydrophobic part, hence they adsorb preferably at interfaces. There they reduce the surface or interfacial tension, respectively, which is essential for good washing performance or the stability of foams.

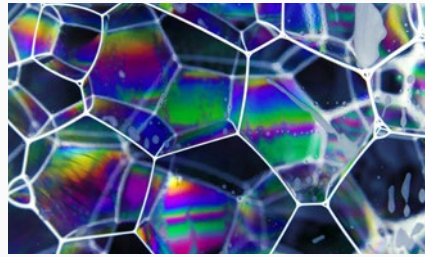

The amount of surfactant molecules that can be accommodated on a certain surface area is limited. The only possibility for 'excess' surfactant molecules to shield their hydrophobic parts from water is by forming **micelles**. The characteristic surfactant concentration that, when reached, initiates the formation of micelles is called "**critical micelle concentration**" (**CMC**). It can easily be determined with a measurement series that varies the surfactant concentration: below the CMC the surface tension decreases with increasing concentration because more and more surfactant molecules adsorb at the surface. Above the CMC, further added surfactant serves only to form micelles and the surface tension stays constant.

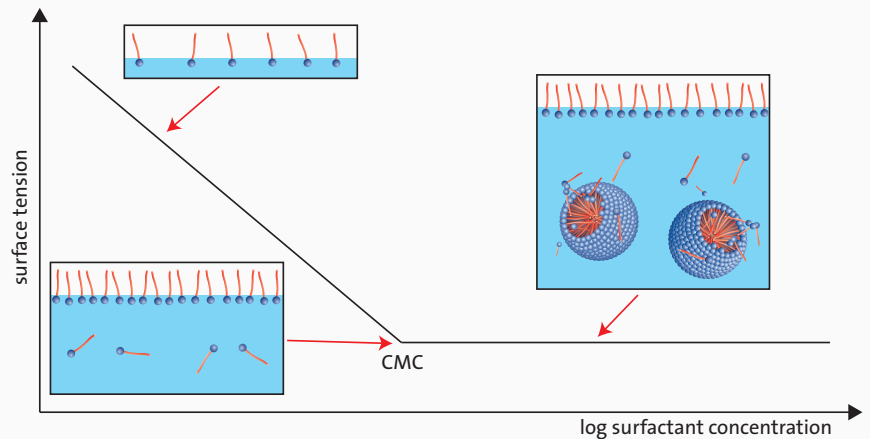

both the buoyancy of the body and the lamella weight. During evaluation the buoyancy contribution is removed from the data so that the **advancing angle** can be determined for the immersion and the **receding angle** for the withdrawal based on the Wilhelmy equation. In addition, the advancing contact angle of powders and fibre bundles can be determined by the **Washburn method**.

Wide field of application

Other tensiometric methods, like the determination of **liquid or solid density**, utilise the measured buoyancy. DataPhysics offers specialised sample holder sets for this purpose. Other specific test bodies and accessory modules can be used in order to investigate **sedimentation and penetration properties, adhesion** or the **surface pressure**.

The **Wilhelmy plate method** is a well-established method for determining surface and interfacial tensions with a tensiometer. The method utilises a Wilhelmy plate as the test body. It is typically made of iridium–platinum and is a few centimetres in length and height. The plate is attached to the weighing system of the tensiometer and positioned at the liquid surface in

such a way that a liquid lamella forms. The gravitational force of the lamella, which equals the perpendicular part of the tensile force caused by the surface tension, is measured. Together with the definition of the surface tension as tensile force per length of the contact line this yields the **Wilhelmy equation**:

$$\sigma = \frac{F_{\text{tens}}}{L} = \frac{F_{\perp}}{L \cdot \cos \Theta_C} = \frac{F_G}{L \cdot \cos \Theta_C}$$

The DCAT models

The dynamic contact angle measuring devices and tensiometer of the **DCAT series** are universal measuring devices, that allow to investigate numerous surface and interfacial properties (see introduction to tensiometry).

Due to the compact and modular product design it is possible to find an individual and best suited combination of device model and accessories for any task.



Liquid temperature control unit TV 70

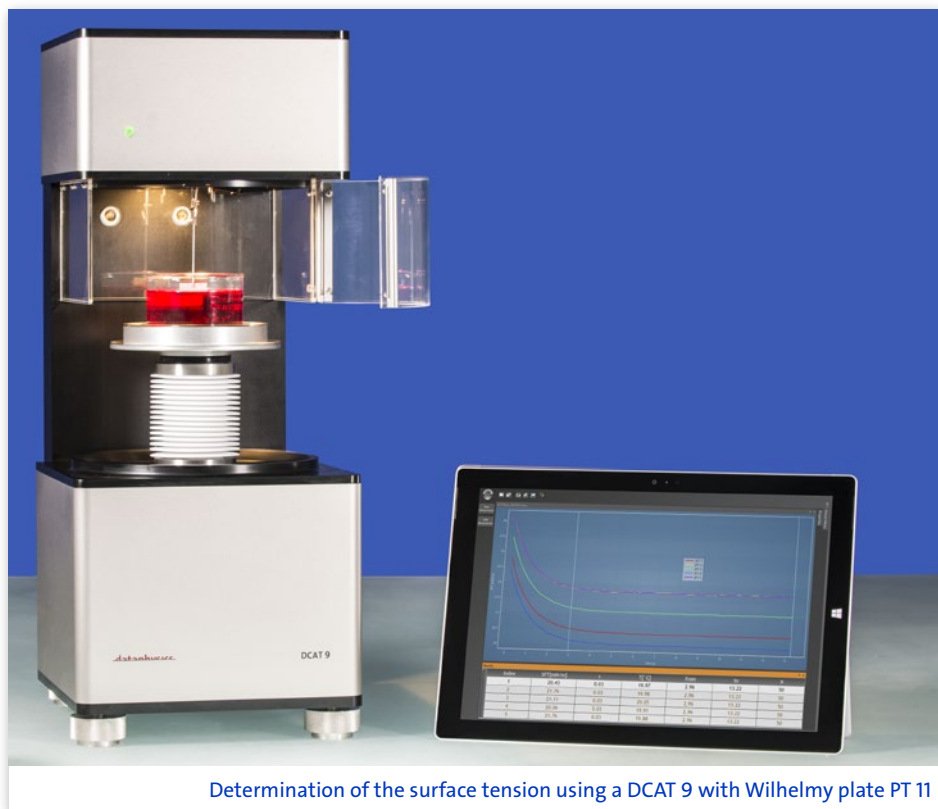

Determination of the surface tension using a DCAT 9 with Wilhelmy plate PT 11

Highest precision and reproducibility of the measuring results is guaranteed by well-established measuring techniques and weighing technology. Due to state of the art electronic components all DCAT models offer an especially **fast and precise actuator**, an **automatic crash protection** and can be operated intuitively via the **TP 50 control panel**.

DCAT 8 & DCAT 9

The **DCAT 8/9** is the powerful **entry level model** for the weight-based measurement of surface and interfacial tension and the density of liquids and solids.

In order to **measure temperature dependent** properties the **DCAT 8T/9T** features an integrated digital thermometer and a liquid temperature control unit TV 70.

DCAT 15

The **DCAT 15** enables additional measuring methods and hence can be used to determine dynamic contact angles, the surface energy of solids or sedimentation and penetration properties.

In addition the DCAT 15 can be extended with a **liquid dosing unit LDU 25** and can thus create sequential concentration series of, for example, surfactant solutions. Without manual user intervention the critical micelle concentration (CMC) can be determined software controlled in a series of experiments.



Determination of the critical micelle concentration with a DCAT 15 and LDU 25 with a syringe holder SH-LDU



LDU 25 with one syringe holder SH-LDU and one refill and rinse system RRS 25

DCAT 25

The dynamic contact angle measuring device and tensiometer **DCAT 25** is the multifunctional **all-round instrument** of the DCAT series. The weighing system is even more precise than that of the DCAT 9 and 15 and hence offers highest accuracy for the determination of surface and interfacial tension. A **completely closed sample chamber** enables measurements under inert gas or ionised atmosphere as well as with controlled relative humidity.



Electrical temperature control unit
TEC 250/DCAT with accessories

Due to the **longer travel distance** of the sample stage, an **electrical temperature control unit** can be mounted inside the DCAT 25 which makes measurements at temperatures of up to 300 °C possible.

Moreover the **Langmuir trough module** can be used to investigate the surface pressure and the interfacial rheology of monolayers.

The **upgrade video system** provides the opportunity to record video-sequences



DCAT 25 with Peltier temperature control unit TV 50-P,
temperature controller TCU and TP 50 control panel

during force of adhesion measurements and to evaluate contact angle, contact area etc. in addition to the force.

The optional **TP 50 control panel with touch screen and precision control wheel** ensures an intuitive and fast device control even during complex measurements.

DCAT 25SF

The **DCAT 25SF** incorporates a **weighing system of highest accuracy** with a resolution of 0.1 µg which allows to measure even on single fibres.

As an ideal **single fibre tensiometer** the DCAT 25SF is not limited to this very special purpose due to the modular design of the product line (see available measuring methods).

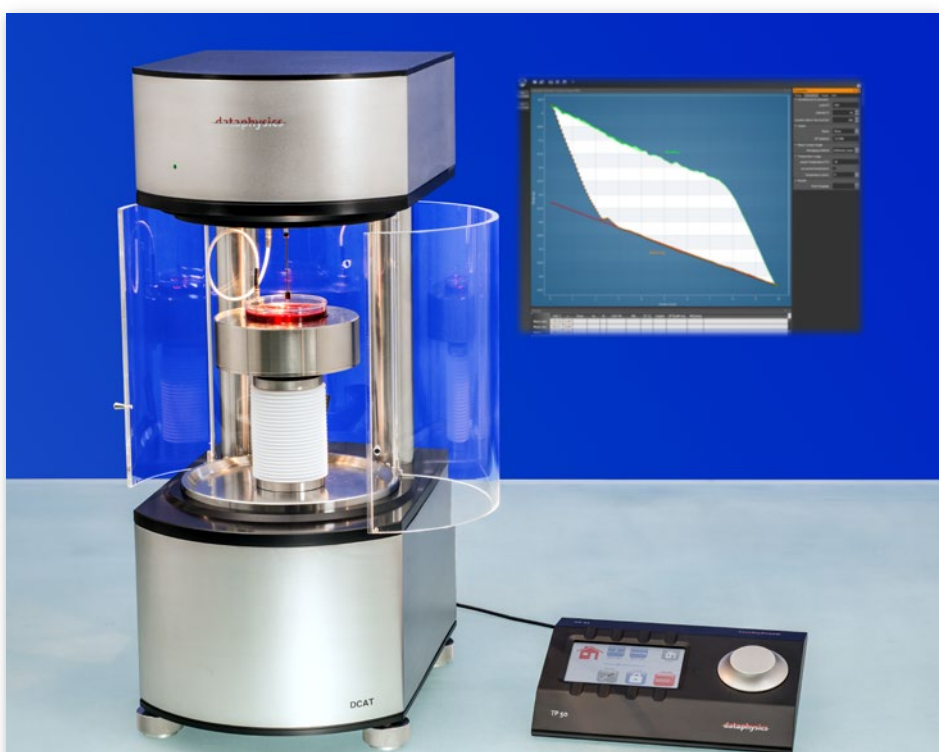

Determination of the contact angle hysteresis on a fibre inside a DCAT 25SF with TP 50 control panel

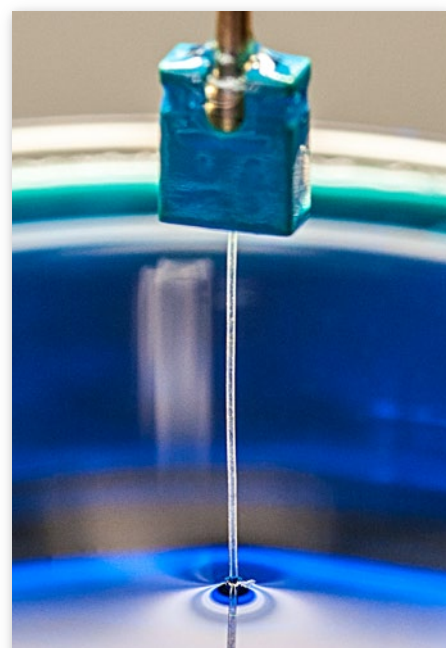

Fibre on a single fibre holder FH 12

Accessories for every task

The modular design of the DCAT models makes it possible to find the right accessory for even the most demanding measuring situation.

Standard test bodies like **Wilhelmy plates** and **Du Noüy rings** are available in different sizes and allow for interfacial and surface tension measurements in compliance to a multitude of national and international standards. For regular verification of the high performance weighing system, **reference weights** with **DAKKS¹ certificate** can be used.

For **density measurements** corresponding sample bodies and holders are available. Different holders enable dynamic contact

angle measurements on plates, films, fibre bundles, powders and even single fibres.

With a **Langmuir trough module** or an **upgrade video system** the application fields of a DCAT can be widened with mono layer investigations and adhesion measurements respectively.

Measurements at temperatures of -15 °C to 135 °C or at up to 300 °C are possible with different **temperature control units** and direct and intuitive control over all electrical device functions is ensured at all times with the **control panel TP 50**.



Control panel with touch-screen TP 50



Set of reference weights RWS

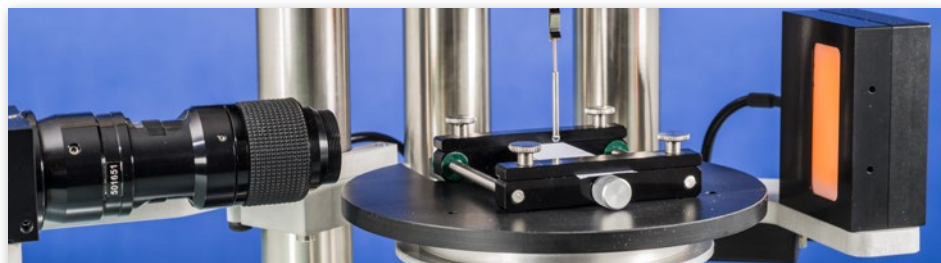

Upgrade video system UpVideo DCAT

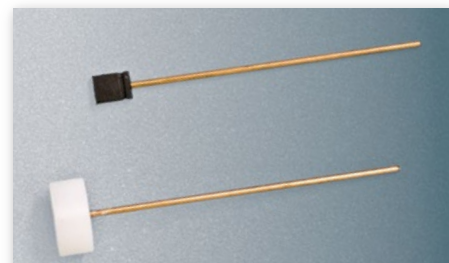

Single fibre holders FH 12 and FH 13

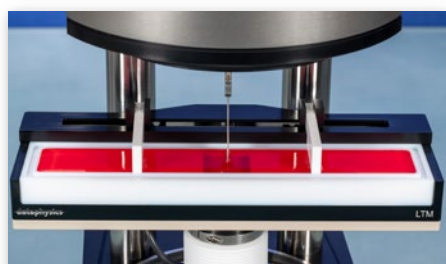

Langmuir trough module LTM

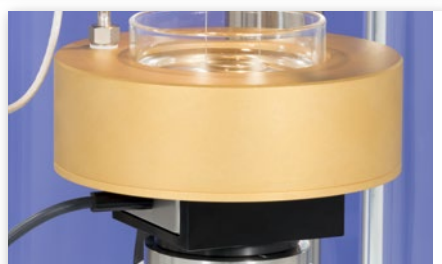

Non-magnetic version of the temperature control unit TV 70NM



Sample vessels GS 70 and GS 50 with matching cover plates CP 70 and CP 50



Density determination set for liquids DIS 11 and Du Noüy rings RG 11 and RG 10

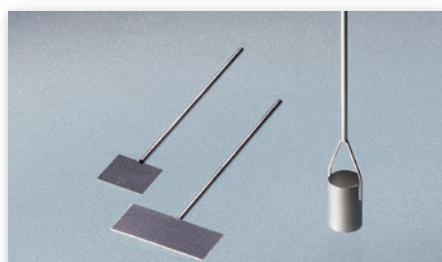

Wilhelmy plates PT 9 and PT 11 and cylindrical plate PT 10

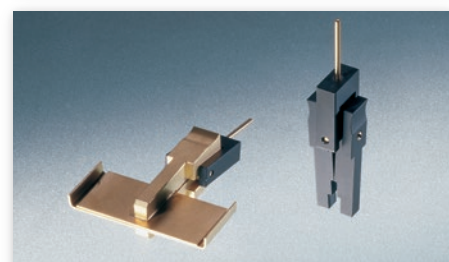

Film holder FO 11 and plate holder PSH 11



Density determination sets for solids DSS 11 and DSS 12



Holders for fibre bundles FH 11 and for powders PUR 11

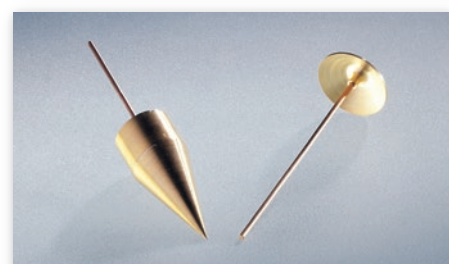

Penetration probe PP 11 and sedimentation cone SC 11

¹ national accreditation body for the Federal Republic of Germany

Innovative software

Software for an efficient workflow

The newly developed, Windows® based, **DCATS** software is available in **various independently usable modules**, and is operable either traditionally, using mouse and keyboard, or on multi-touch notebooks/pads by finger or pen.

The **modern user interface** is multilingual (English, German, Chinese), highly customisable and offers every user an individual and ideally suited overview during measurements.

The **comprehensive integrated help function** includes explanations for the measurement procedures and used calculations and supports the user in setting up measurement parameters.

With previously created measurement templates “**1-click-measurements**” can be easily carried out and the **automatic storage** of every measurement ensures that no data is lost.

Individually designed measurement reports present all results in the best possible way.

The DCATS is split into the following separately available modules:



DCATS 31 — surface/interfacial tension

- determination of the static, time and temperature dependant surface and interfacial tension according to the Du Noüy ring, the Du Noüy paddy and the Wilhelmy plate method
- Automatic ring corrections according to various methods

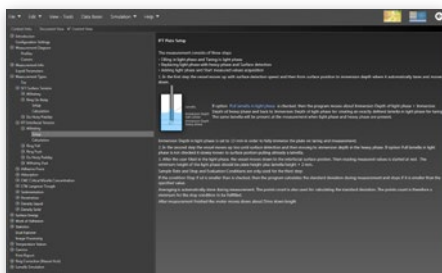
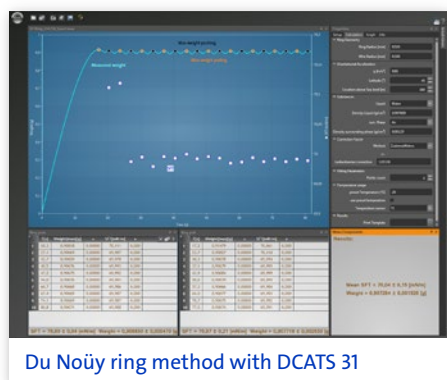

DCATS 32 — dynamic contact angle

- determination of the dynamic contact angle of solids (e.g. plates, films, rods, fibres)
- sorption measurements on powders and fibre bundles
- determination of the average contact angle according to the modified and the extended Washburn method
- analysis of the surface energy of solids as well as its components according to nine different theories

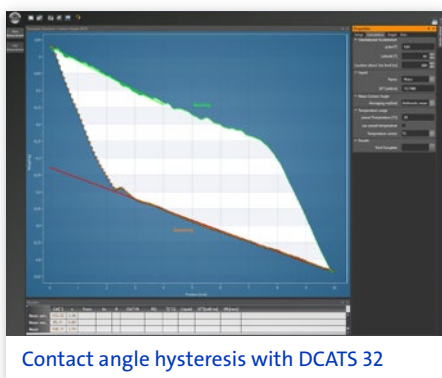

DCATS 33 — CMC

- automated determination of the critical micelle formation concentration (CMC) of surfactants, using the dosing unit LDU 25 for additive and subtractive dosing

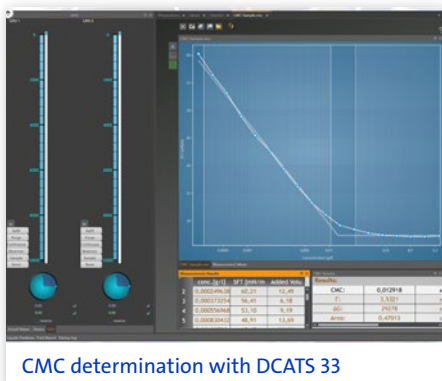

DCATS 34 — liquid density

- determination of the density of liquids

DCATS 35 — sedimentation/penetration

- determination of the sedimentation rate, yield forces, the penetration resistance and rate

DCATS 36 — solid density

- determination of the density of solids

DCATS 37 — adhesive force

- measurement of force-distance diagrams during pressing on and pulling off of liquid drops for adhesion analysis
- image processing (contact angle, contact area, etc.) of video sequences correlated with the measurement (with optional UpVideo DCAT module)

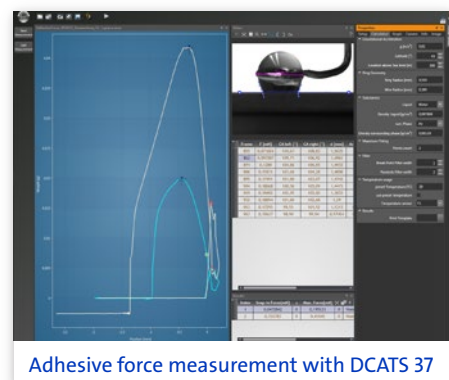

DCATS 38 — surface pressure

- determination of the surface pressure of a monolayer during its compression and relaxation in the Langmuir trough module LTM
- kinetic measurements under isobaric or isochoric conditions to analyse dynamic processes in a monolayer in the LTM
- interfacial rheological analysis of viscoelastic monolayers in the LTM

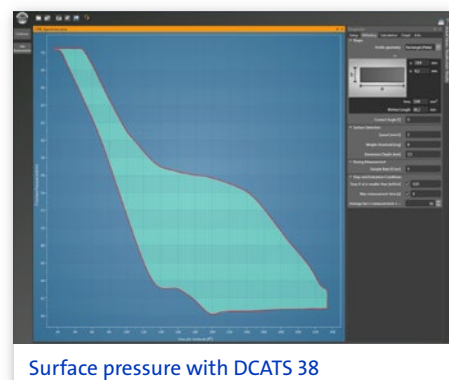

Available measuring methods and technical data

	DCAT 8	8T	DCAT 9	9T	DCAT 15	DCAT 25	DCAT 25SF
Weighing range	100 µg ... 220 g				10 µg ... 210 g		1 µg ... 10 g
resolution; accuracy	100 µg; ± 100 µg				10 µg; ± 20 µg		0.1 µg; ± 3 µg
measuring value rate [values/s]	up to 10		up to 100				up to 50
Surface and interfacial tension [DCATS 31]	○		○		○	○	○
measuring range					1 ... 2000 mN/m		
resolution					± 0.01 mN/m		± 0.0001 mN/m
ring correction options	Huh-Mason, Zuidema-Waters, Harkins-Jordan, Lunkenheimer factor, linear, polynomial, none						
Density determination							
liquid density [DCATS 34]	○		○		○	○	○
solid density [DCATS 36]	○		○		○	○	—
measuring range					0.001 ... 2.50 g/cm ³		
resolution					± 0.0001 g/cm ³		
Dynamic contact angle [DCATS 32]	—		—		○	○	○
measuring range	—		—			0 ... 180°	
resolution	—		—			± 0.01°	
Automated CMC determination [DCATS 33]	—		—		○	○	○
Sedimentation and penetration [DCATS 35]	—		—		○	○	—
Adhesion [DCATS 37]	—		—		○	○	—
Upgrade video system UpVideo DCAT	—		—		—	○	—
Surface pressure [DCATS 38]	—		—		—	○	○
pH value measurement	○		○		○	○	○
Sample stage	motorised with automatic crash protection						
traversing range			80 mm				105 mm
traversing speed	46 nm/s ... 6 mm/s				46 nm/s ... 12 mm/s		
travel resolution					24 nm		
Temperature control							
via liquid circulator (-10 ... 130 °C)	—	●	—	●	○	○	○
via Peltier element (-15 ... 135 °C)	—	○	—	○	○	○	○
via electric heating chamber (RT...300 °C)	—	—	—	—	—	○	—
2 x Pt100 inputs for -60 ... +450 °C ± 0.01 K	—	●	—	●	●	●	●
Multilingual Software	English, German, French, Chinese						
Compliance with international standards	a comprehensive list can be found online: www.dataphysics-instruments.com/standards/						
TP 50 control panel	○		○		○	○	●
Automatic stirrer	● (magnetic)		● (magnetic)		● (magnetic)	● (magnetic)	○ (non-magnetic)
Balance calibration	automatic internal and external with reference weights						
Dimensions (L [mm] x W [mm] x H [mm])	271 x 246 x 523				360 x 230 x 565		
Weight [kg]	16	17	15	16	16	23	24
Power supply	100 ... 240 VAC; 50 ... 60 Hz; 70 W						

● integrated

○ with optional software/accessory

— not available

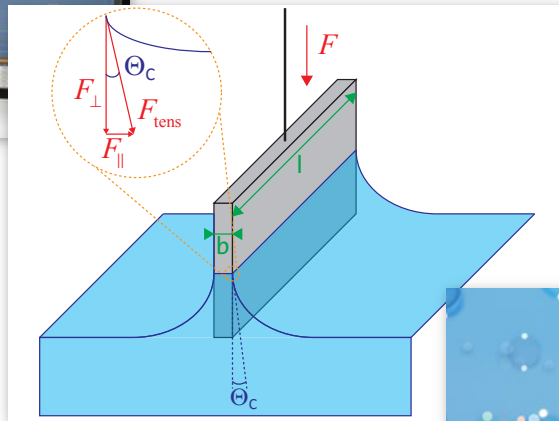
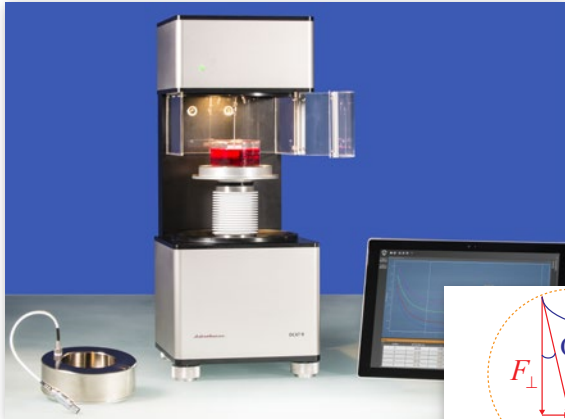

**For more information please contact us.
We will find a tailor-made solution to your
surface chemistry requirements and
will be pleased to provide a quotation,
obligation-free, for your instrument system.**

DataPhysics Instruments GmbH • Raiffeisenstraße 34 • 70794 Filderstadt, Germany
phone +49 (0)711 770556-0 • fax +49 (0)711 770556-99
sales@dataphysics-instruments.com • www.dataphysics-instruments.com

Your sales partner: