

VERDERGEAR Process made by Liquiflo Gear pump PFA P4

Description

PFA-Lined Gear Pumps Series pumps offer a durably constructed outer Stainless Steel body with a heavily layered Fluoro-Polymer (PFA) internal lining. This highly chemically resistant PFA lining is mechanically attached and bonded to the internal stainless steel surfaces using a specialized molding process, effectively isolating the fluid being pumped from any metal surfaces. Fluoro-Polymers exhibit the highest corrosion resistance of any plastics. This combination of stainless steel on the outside and Fluoro-Polymer on the inside gives the Poly-Guard™ the full strength and integrity of a metal pump with the ultimate corrosion resistance of a Fluoro-Polymer.



Advantages

- The Poly-Guard™ offers both internal and external protection against corrosive fluids and harsh environments
- Strong Stainless Steel body handles pipe stresses and typical treatments found in industrial environments
- Fluoro-Polymer-lined for ultimate protection against any corrosive liquids, such as Acids, Caustics, Inorganic Salts and others
- A variety of non-metallic materials for internal components such as PEEK, Kynar (PVDF), Teflon, Silicon Carbide and TTZ, were chosen for exceptional wear resistance and chemical compatibility, allowing pump to be optimized for the intended service
- Ideal for high purity services (All wetted parts are non-metallic)
- Sealless Mag-Drive configuration prevents leakage
- Rotary Gear Pump design delivers a smooth, pulse less flow which is desirable for both metering and transfer applications
- Close-Coupled configuration simplifies installation and maintains perfect alignment of pump and motor
- Product is extremely simple in design and easy to maintain and repair
- Available in 5 sizes to match your flow requirements up to 57 LPM

Application areas

- Chemical
- Water Treatment
- Pharmaceutical
- Pulp & Paper
- Electronics
- Food & beverage
- High Purity Service

Technical Data

Max. flow range	19 l/min
Max. speed range	1750 Rpm
Max. pressure	7 bar
Max. temperature	100 °C
Max. viscosity	100 mPas

VERDERGEAR Process made by Liquiflo Gear pump PFA P4

Flow curve

Water (1 mPas)

Oil (100 mPas)

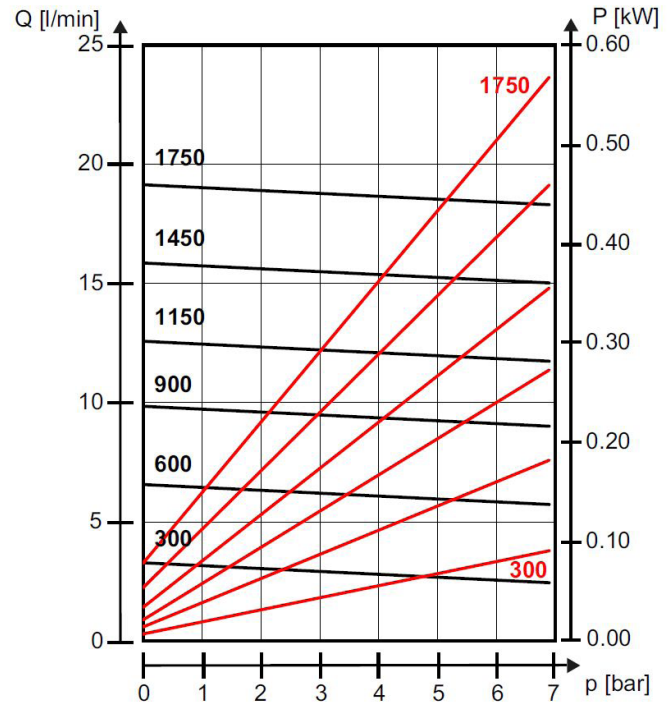
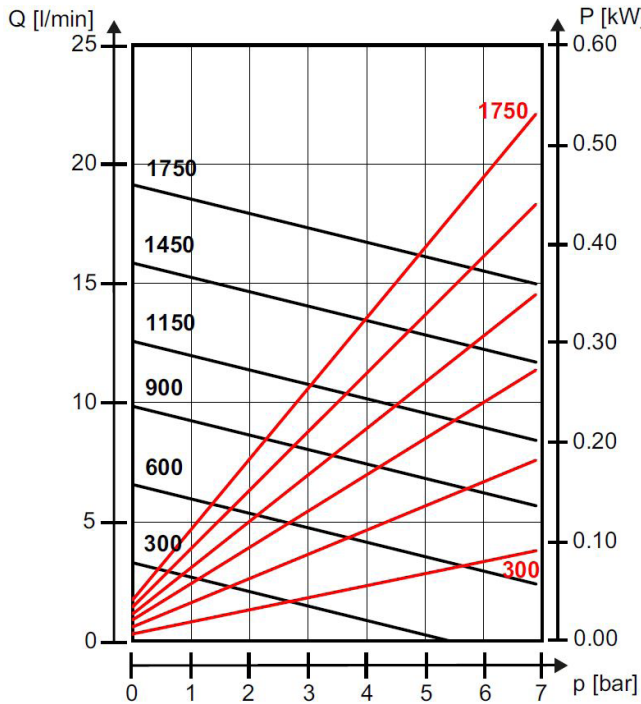

Drawing

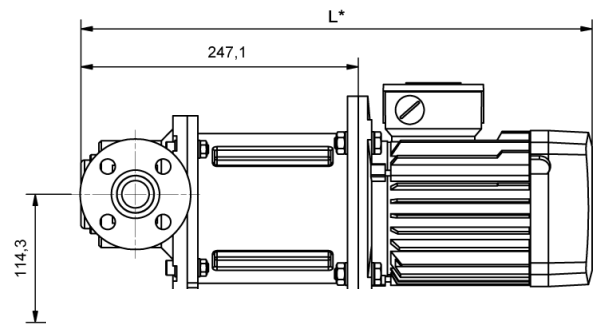
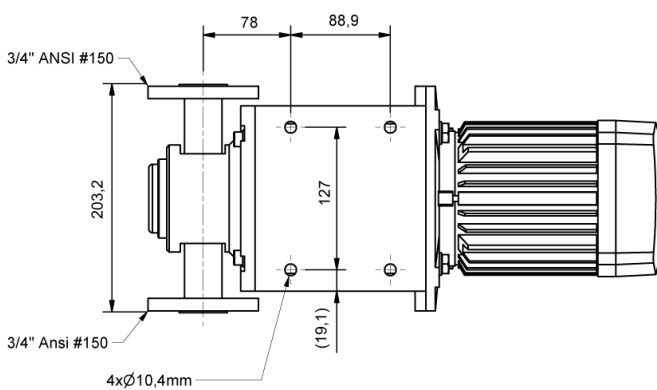

*L: Measurement depends on the motor size.

