

BORDURES GRISES

BORDURES CLASSIQUES

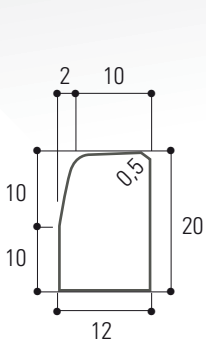

T1

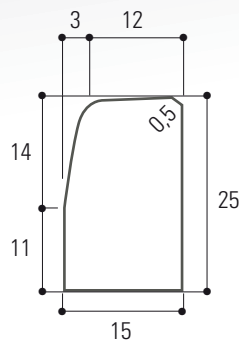

T2

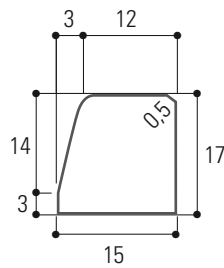

T2 charretière

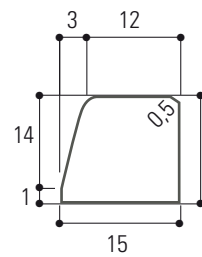

T2 charretière Ht 15

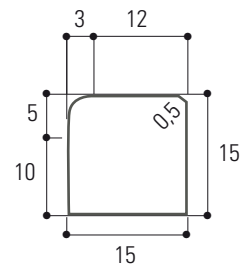

T2 basse

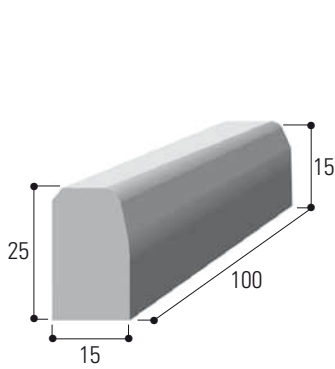

T2 biaisé

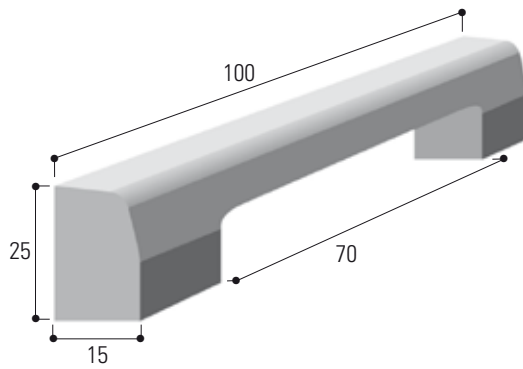

T2 avaloir

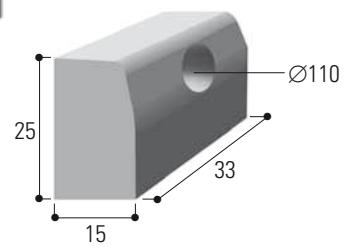

T2 gargouille

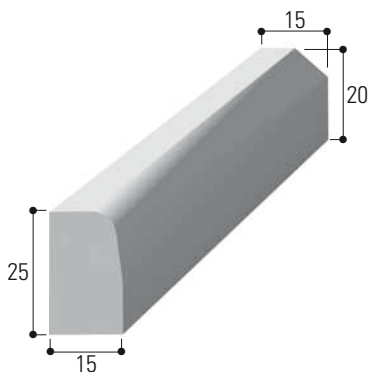

Raccord T2/A2

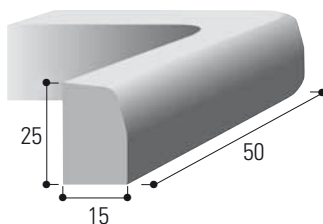

T2 d'angle

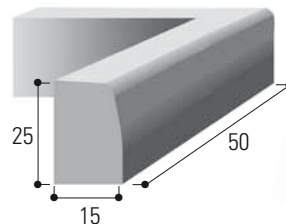

T2 d'angle vif

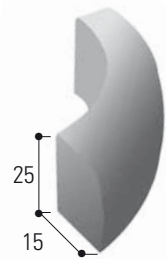

T2 courbe

BORDURE TYPE T1

CARACTÉRISTIQUES TECHNIQUES

Nouveau code	Ancien code	Article	L (cm)	Poids unité/kg	Nombre/palette	Poids/palette
028057	6000	Bordure T1 C€6.0 NF U	100	52	24	1 248

BORDURE TYPE T2

CARACTÉRISTIQUES TECHNIQUES

Nouveau code	Ancien code	Article	L (cm)	Poids unité/kg	Nombre/palette	Poids/palette
028071	6004	Bordure T2 C€6.0 NF U	100	81	18	1 458
026046	4465	Bordure T2 basse C€6.0	100	53	24	1 272
084138	4464	Bordure T2 charretière C€6.0	100	52,5	24	1 260
113821	-	Bordure T2 charretière Ht 15	100	47	30	1 410
051932	4473	Bordure T2 biaise C€6.0 (6D et 6G)	100	69	12	828
026107	4470	Raccord T2/A2 C€6.0 (6D et 6G)	100	73	12	876
026428	4622	Bordure T2 avaloir C€3.5	100	42	12	504
026459	4625	Bordure T2 gargouille en 0,33 ml C€3.5	33	24	54	1 296
027920	5611	Bordure T2 d'angle C€3.5 (4 éléments)	50 x 50 ext.	80	4	320
Nous consulter	-	Bordure T2 angle vif C€3.5	50 x 50 ext.	-	4	-
101767	T2R05	Bordure T2 R050 C€3.5				
103587	T2R06	Bordure T2 R060 C€3.5			Rayon 0,50 ml à 1 ml tous les 10 cm	
101835	T2R07	Bordure T2 R7 C€3.5				
100647	T2R10	Bordure T2 R100 C€3.5				
101842	T2R12	Bordure T2 R120 C€3.5			Rayon 1,20 ml à 2 ml tous les 20 cm	
103822	T2R14	Bordure T2 R140 C€3.5				
101859	T2R20	Bordure T2 R20 C€3.5				
105307	T2R30	Bordure T2 R30 C€3.5				
101750	T2R50	Bordure T2 R50 C€3.5			Rayon 3 ml à 9 ml tous les 1 ml	
101002	T2R60	Bordure T2 R60 C€3.5				
028088	60040	Bordure T2 C€6.0 NF U ocre	100	81	18	1 458
026053	44650	Bordure T2 basse ocre C€6.0	100	53	24	1 272

BORDURES GRISES

BORDURES CLASSIQUES

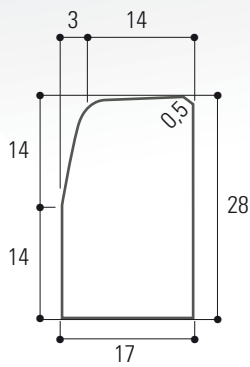

T3

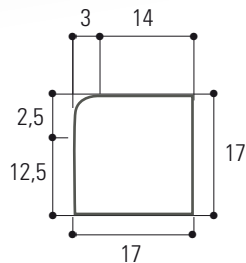

T3 basse

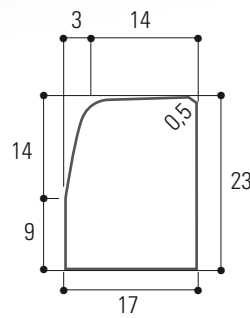

T3 réduite

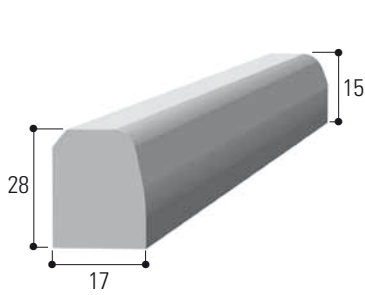

T3 biaise

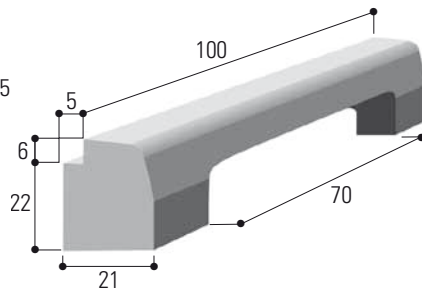

T3 avaloir traversant

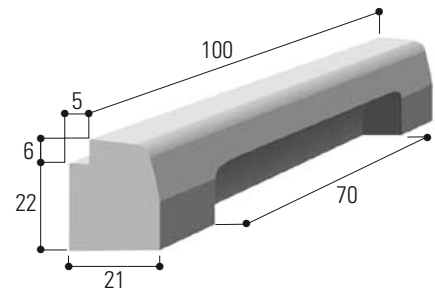

T3 avaloir non traversant

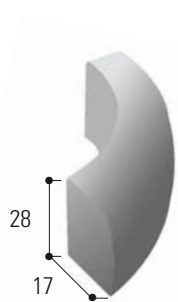

T3 courbe

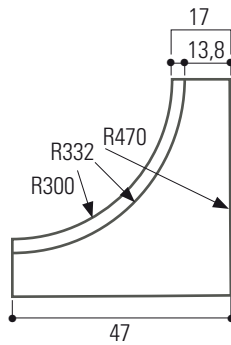

T3 concave

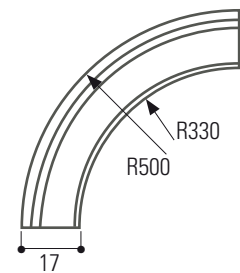

T3 convexe

BORDURE TYPE T3

CARACTÉRISTIQUES TECHNIQUES

Nouveau code	Ancien code	Article	L (cm)	Poids unité/kg	Nombre/palette	Poids/palette
110707	6007	Bordure T3 C€ 6.0  U	100	104	12	1 248
028125	6010	Bordure T3 EN 0,50 ML C€ 6.0	50	53	30	1 590
097985	T3BASSE	Bordure T3 basse C€ 6.0	100	63	24	1 512
026060	4466	Bordure T3 réduite C€ 6.0	100	83	15	1 245
026558	4680	Bordure T3 avaloir traversant C€ 3.5	100	66	8	528
026589	4690	Bordure T3 avaloir non traversant C€ 3.5	100	85	8	680
110868	2000020	Bordure T3 biaisée C€ 6.0 (3D et 3G)	100	76	6	456
Nous consulter*	-	Bordure T3 concave C€ 3.5	47 x 47 ext.	93	-	-
111605	-	Bordure T3 convexe C€ 3.5	50 x 50 ext.	65,5	5	327,5

* Consulter le service commercial

Bordure biaisée droite

(inclinée vers la droite lorsque face au trottoir)

Bordure biaisée gauche

(inclinée vers la gauche lorsque face au trottoir)

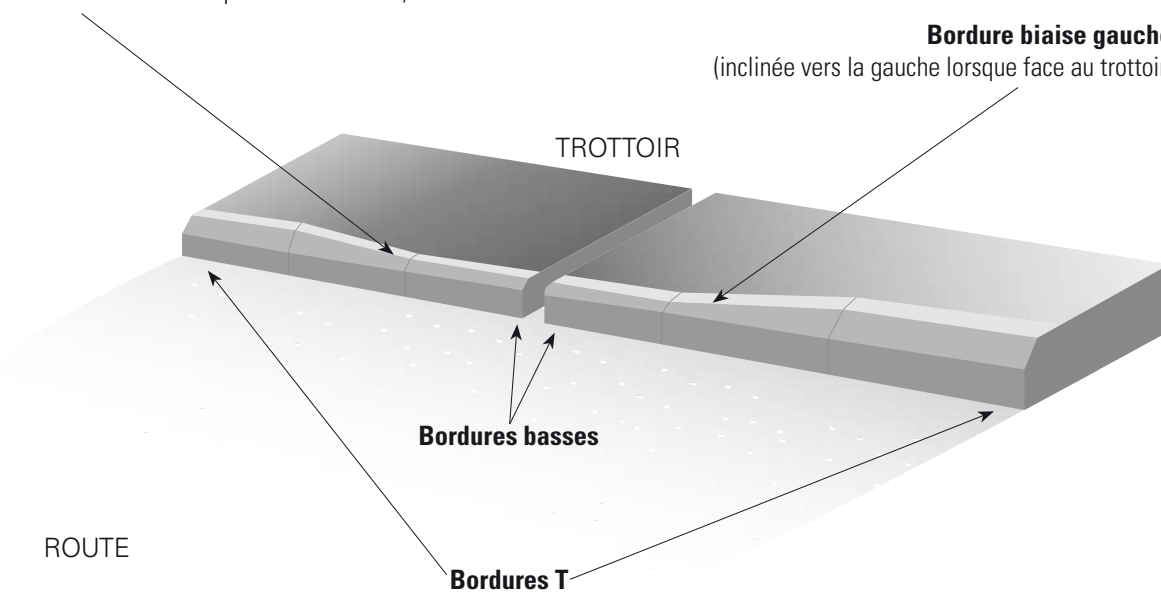

BORDURES GRISES

BORDURES CLASSIQUES

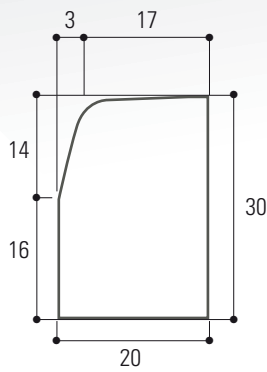

T4

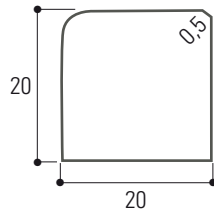

T4 basse

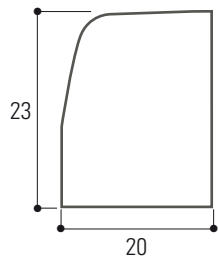

T4 réduite

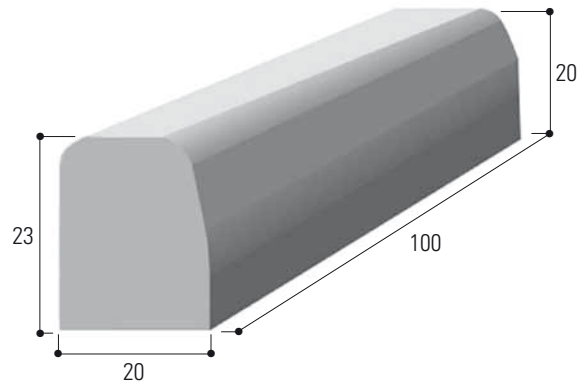

Raccord T4R/T4 basse

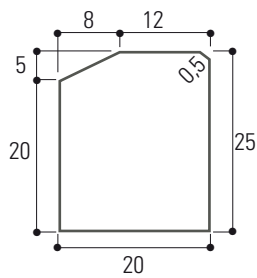

A1

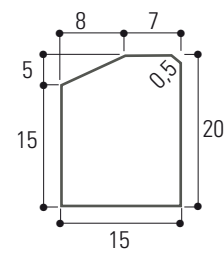

A2

BORDURE TYPE T4

CARACTÉRISTIQUES TECHNIQUES

Nouveau code	Ancien code	Article	L (cm)	Poids unité/kg	Nombre/palette	Poids/palette
028293	6070	Bordure T4 C€6.0 NF U	100	132	10	1 320
106632	4467	Bordure T4 basse C€6.0	100	91	15	1 365
026084	4468	Bordure T4 réduite C€6.0	100	101	15	1 515
107004	4476	Raccord T4R/T4 basse C€6.0 (4D et 4G)	100	89	8	712

BORDURE TYPE A1 & A2

CARACTÉRISTIQUES TECHNIQUES

Nouveau code	Ancien code	Article	L (cm)	Poids unité/kg	Nombre/palette	Poids/palette
091358	8012BS	Bordure A1 C€6.0 NF U	100	115	16	1 840
028262	6055	Bordure A2 C€6.0 NF U	100	64	24	1 536

INFORMATION :

Le mortier de joint des bordures doit être dosé à 200 kg/m³ (sans jamais excéder 250 kg/m³)

Voir nos conseils en page 78 et 79 du catalogue

BORDURES GRISES

BORDURES CLASSIQUES

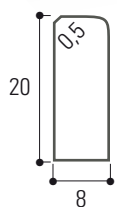

P1

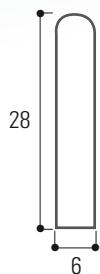

P2



P3

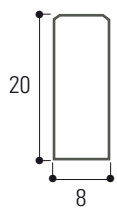

CR1

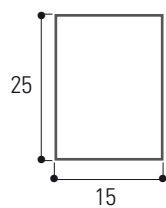

CR3

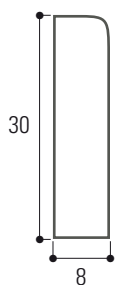

Bordure 8 x 30



Bordure 5 x 20

BORDURE TYPE P1

CARACTÉRISTIQUES TECHNIQUES

Nouveau code	Ancien code	Article	L (cm)	Poids unité/kg	Nombre/palette	Poids/palette
091532	2147BS	Bordure P1 C € 6.0 NF U	100	36	40	1 440
106809	2147O	Bordure P1 ocre C € 6.0 NF U	100	36	40	1 440
106779	2147R	Bordure P1 rouge C € 6.0 NF U	100	36	40	1 440
106786	2147J	Bordure P1 jaune C € 6.0 NF U	100	36	40	1 440

BORDURE TYPE P2

CARACTÉRISTIQUES TECHNIQUES

Nouveau code	Ancien code	Article	L (cm)	Poids unité/kg	Nombre/palette	Poids/palette
110790	2000009	Bordure P2 C € 6.0 NF U	100	37	30	1 110
112244	-	Bordure P2 ocre C € 6.0 NF U	100	37	30	1 110
112251	-	Bordure P2 rouge C € 6.0 NF U	100	37	30	1 110
112268	-	Bordure P2 jaune C € 6.0 NF U	100	37	30	1 110

BORDURE TYPE P3

CARACTÉRISTIQUES TECHNIQUES

Nouveau code	Ancien code	Article	L (cm)	Poids unité/kg	Nombre/palette	Poids/palette
109329	2164	Bordure P3 C € 6.0	100	27	36	972
028521	7805	Bordure P3 ocre C € 6.0	100	27	36	972

BORDURE TYPE CR1 & CR3

CARACTÉRISTIQUES TECHNIQUES

Nouveau code	Ancien code	Article	L (cm)	Poids unité/kg	Nombre/palette	Poids/palette
047041	4500	Bordure CR1 C € 6.0	100	36,50	44	1 606
102979	4504	Bordure CR3 C € 6.0	100	87	18	1 566

BORDURE TYPE 8 x 30 & 5 x 20

CARACTÉRISTIQUES TECHNIQUES

Nouveau code	Ancien code	Article	L (cm)	Poids unité/kg	Nombre/palette	Poids/palette
113906	-	Bordure 8 x 30 en 1 ml PL	100	52	24	1 248
114682	-	Bordure 8 x 30 en 0,50 ml PL	50	26	48	1 248
114699	-	Bordure 5 x 20 en 1 ml PL	100	21,30	50	1 065