

UV-VIS Spectrophotometer

# UV-1280



UV-VIS Spectrophotometer

# UV-1280

## 1 Easy to Operate

Easy-to-see LCD and buttons ensure simple measurement and instrument validation operations.

## 2 A Wealth of Measurement Modes

- From photometric measurements to DNA/protein quantitation.
- Fully equipped with the programs needed for UV/VIS analysis, even for high-level multi-component quantitation.
- Accommodates a variety of applications due to a wealth of available accessories.

## 3 Data Storage on USB Flash Drives

- Data from the unit can be saved directly to a USB flash drive.
- Data can be displayed using commercially available spreadsheet software.

## 4 Stable Measurements

- Combined monitor double-beam system for the D<sub>2</sub>/W1 lamps.
- Highly stable analyses in a compact unit.

Designed by the leaders in UV-Visible Spectroscopy for molecular absorption quantitative analysis, the UV-1280 Multipurpose UV-Visible Spectrophotometer offers wavelength scanning from 190-1100nm. This lower-cost, high-quality instrument is ideal for applications ranging from routine environmental and food quality testing to life science analyses.



## Easy to Operate



UV-1280 + MPU screen copy printer (option)

Prints hard copies of screens, including numerical data. It also allows printing of the items displayed on the screen, such as spectra and calibration curves.



UV-1280 + Commercial printer (option)

Printing is possible to printers that support ESC/P-9, ESC/P-24, ESC/P Raster, and PCL control codes.

For details on compatible commercially available printers, contact your Shimadzu representative.



The easy-to-see LCD and buttons enable user-friendly, intuitive measurement, instrument validation, and printing operations.

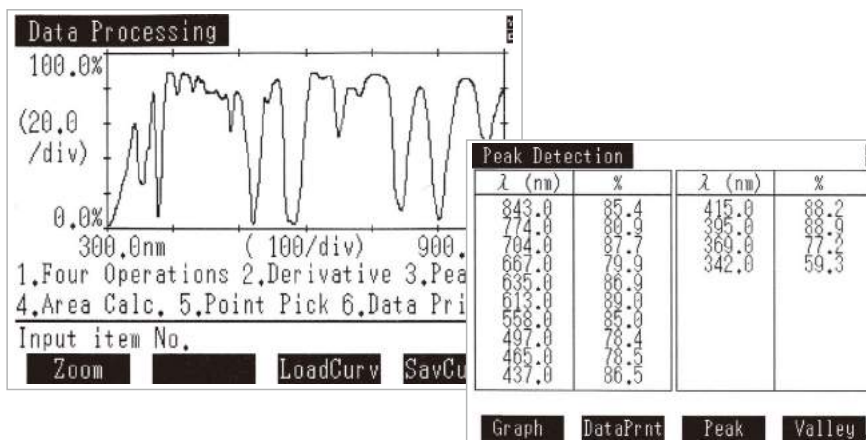

Instrument validation and maintenance/inspection functions have been enhanced.

### Instrument Validation Functions

- The checks for JIS items can be performed automatically or semi-automatically.
- Linking with a 6-series multi-cell (optional) is possible, making sample replacement unnecessary. Inspections can be performed efficiently.

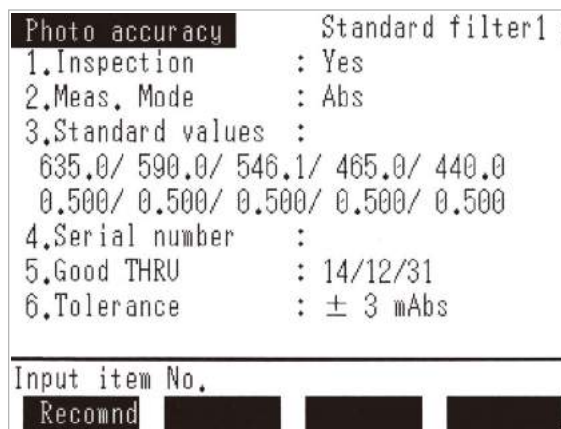
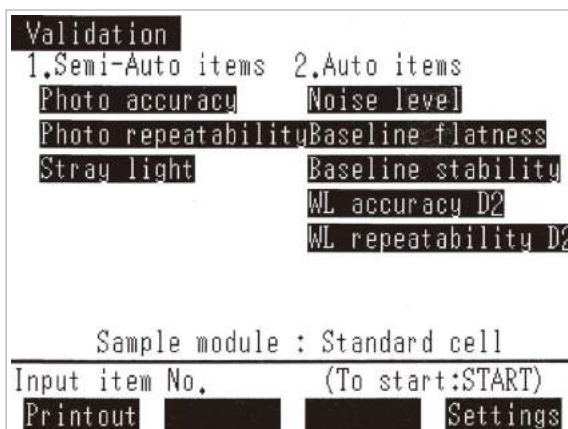

### Instrument Maintenance and Inspections

The usage times of the deuterium (D<sub>2</sub>) lamp and the halogen (WI) lamp can be recorded and displayed, which enables users to ascertain the expected replacement period of the lamps when performing periodic inspections.

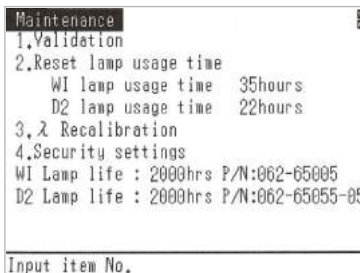

# A Variety of High-Level Measurement Modes

Equipped with a range of programs, the UV-1280 can be used for everything from photometric, spectral, and kinetics measurements to DNA/protein and high-level multi-component quantitation.

## 1 Photometric Mode

Measures the absorbance or transmittance at a single wavelength or multiple (up to eight) wavelengths. The instrument is also capable of simple quantitation using the K-factor method. For a multiple-wavelength measurement, calculations can be performed on the data obtained for up to four wavelengths, including the calculation of the difference between, or ratio of, the measurements obtained for two wavelengths.

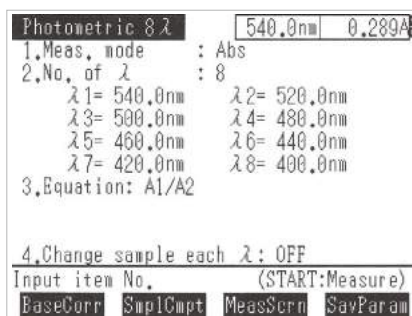
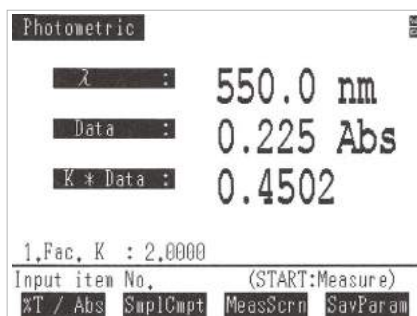

## 2 Spectrum Mode

A sample spectrum is recorded using wavelength scanning. Repeat scans let you follow sample changes over time. Zoom in on the finished spectrum for a better view; subsequently, use the peak/valley pick function to select maxima and minima and perform a wide variety of data processing functions.

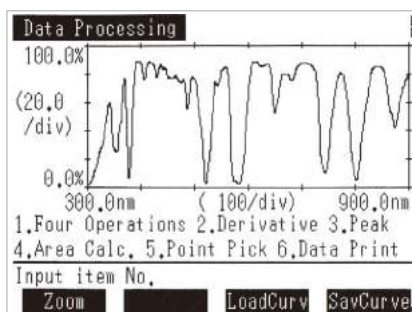

## 3 Quantitation Mode

Generates a calibration curve from the measurement of standards, and then calculates the concentrations of unknowns. Allows various combinations of wavelength number (1 to 3 wavelengths and derivatives) and calibration curves (K-factor and first-to-third order).

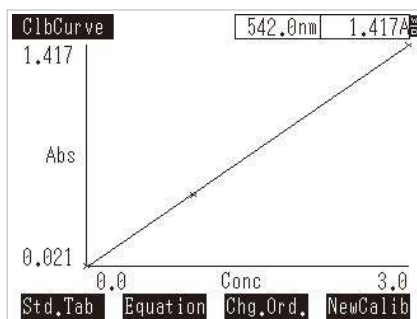

Quantitation

Smpl No.	Abs	Conc. (mg/ml)
1	0.911	1.9241
2	0.908	1.9176
3	0.482	1.0047
4	0.475	0.9897
5	0.488	1.0176
6	0.479	0.9983
7	0.485	1.0112
8	0.652	1.3690

▲ : PrevData ▼ : NextData 1/ 2

PrntData LoadData

## 4 Kinetics Mode

Measures absorbance changes as a function of time, and obtains the enzymatic activity values. The kinetics measurement method automatically calculates the amount of change per minute, and then calculates an activity value from a specified coefficient. The rate measurement method, which determines whether the absorbance is changing linearly, can also be selected. In addition, add the CPS-100 thermoelectrically temperature-controlled cell positioner for measurement of multiple samples in succession.

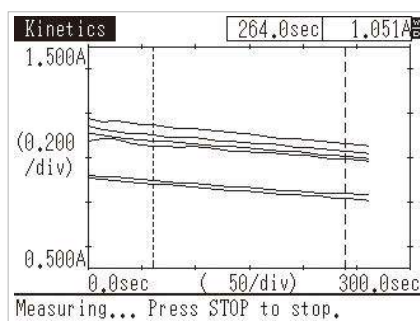

Kinetics		340.0nm	1.038A
Smp No.	Init(Abs)	$\Delta A/\text{min}$	Activ.
1- 1	0.906	-0.0225	134.93
1- 2	0.921	-0.0208	125.00
1- 3	1.074	-0.0209	125.58
1- 4	1.106	-0.0240	143.89
1- 5	1.144	-0.0237	142.30
1- 6	1.176	-0.0277	166.06
2			

Press START to measure. (CE:Delete data)

Smpl No. Curve DataDisp SaveData

## 5 Time Scan Mode

Measures the change in absorbance, transmittance or energy as a function of time. Add the CPS-100 thermoelectrically temperature-controlled cell positioner for simultaneous measurement of multiple samples under constant-temperature conditions.

## 6 Multi-Component Quantitation Mode

Quantitates up to eight components mixed in a single sample. The calibration equation is determined using pure or mixed components with known values.

Multi-Component		500.0nm	-0.000A
1.Scan range	: 500nm ~ 220nm		
2.Rec. range	: 0.000A ~ 2.000A		
3.Scan speed	: Medium		
4.Display mode	: Sequential		
5.No. of component	: 3		
6.Standard type	: Pure		
7.No. of Standard	: 3		
8.Meas. $\lambda$	: Defined		
9.Standard data	: Defined		
Input item No. (START:Measure)			
BaseCorr	SmplCmpt	MeasScrn	SavParam

## 7 Biomethod Mode

Determine DNA and protein concentrations with the following quantitation methods using the bioscience/life science program included as standard.

### DNA/Protein Quantitation

• Quantitates DNA or protein using the absorbance at 260/230 nm or 260/280 nm.

### Protein Quantitation

- Lowry method
- BCA method (method using bicinchoninic acid)
- Biuret method
- CBB method (method using Coomassie Brilliant Blue G-250)
- UV absorption method (direct measurement at 280 nm)

DNA Quantitation		320.0nm	0.001A
Smpl No. = 1			
A1( 260.0)	= 0.307		
A2( 280.0)	= 0.232		
Ab( 320.0)	= 0.110		
Abs Ratio	= 1.6137		
DNA Conc	= 8.0047		
Protein Conc	= 40.315		
Press START to measure. (CE:Delete data)			
Smpl No.		DataDisp	SaveData

# Data Storage on USB USB Flash Drives



Using USB flash drives makes it easy to transport analysis data and to store large amounts of data in a PC.

- USB flash drives can be connected directly to the UV-1280.
- Data for spectra and time-course curves can be displayed and saved with commercial spreadsheet software.

## UV-1280 + USB flash drive + PC

With the UV-1280, the curve-related data (spectra and time-course curves) can be converted to, and saved in, CSV format. Transferring this data with USB flash drives allows it to be read directly at a PC using commercial spreadsheet software.

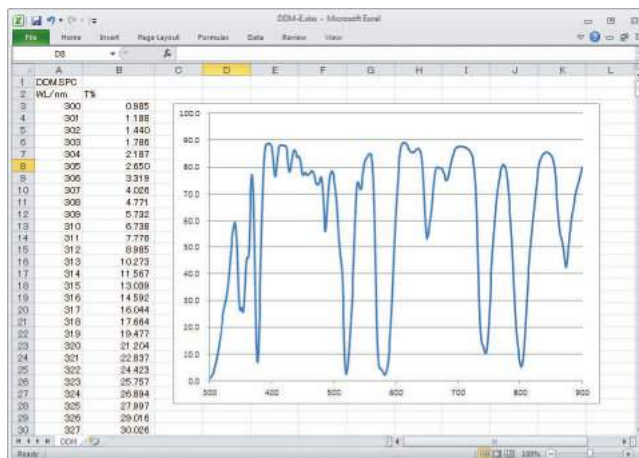





## Analysis Compatibility Table

Pharmaceuticals and Life Sciences	
DNA/protein quantitation	Optimal
Culture fluid turbidity measurements	Optimal
Enzymatic reaction measurements	Optimal
Chemicals	
Transmittance measurements for films	Optimal
Thickness measurements for thin films and other films	Suboptimal
Foods	
Pigment measurements	Optimal
Quantitation of vitamins, food additives, and minerals	Optimal
Environmental	
Turbidity measurements	Optimal
Quantitation of total phosphorus and total nitrogen in river water, and lakes and marshes	Optimal
Measurements of plating liquids (hexavalent chromium, aluminum, nickel, etc.)	Optimal
Quantitation of iron, copper, arsenic, and ammonia in water	Optimal

# Applications

## Pharmaceuticals and Life Sciences

The UV-1280 includes programs for enzymatic reaction measurements, and DNA/protein quantitation, essential in bioscience/life science fields. A monitor double-beam has been adopted using a highly stable deuterium lamp and halogen lamp, which is optimal for kinetics measurements tracking changes over time. With a wealth of accessories, this instrument can even accommodate trace samples and measurements as is in test tubes.

## DNA/Protein Quantitation

### Program: DNA/Protein Quantitation

Easily obtain DNA and protein concentrations, which are measured directly from absorption bands in the UV wavelength region, without performing coloring operations. With preset wavelengths and computational formulas, simply position the sample and press the START/STOP key for one-touch quantitation results. The measurement wavelengths and computational coefficients can be freely changed.

Calculates two-wavelength absorbance ratios and DNA/protein concentrations. Select from the following two quantitation formulas\*:

\*Absorbance at 320 nm can be used for background correction.

1) A1 = 260 nm absorbance; A2 = 230 nm absorbance

Absorbance ratio = A1/A2

DNA concentration =  $49.1 \times A1 - 3.48 \times A2$

Protein concentration =  $183.0 \times A2 - 75.8 \times A1$

2) A1 = 260 nm absorbance; A2 = 280 nm absorbance

Absorbance ratio = A1/A2

DNA concentration =  $62.9 \times A1 - 36.0 \times A2$

Protein concentration =  $1552.0 \times A2 - 757.3 \times A1$

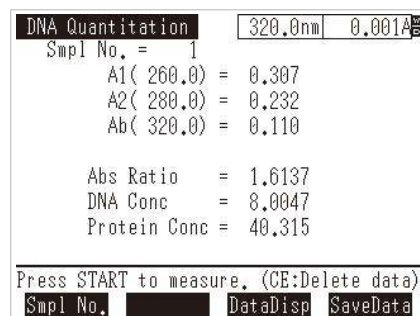

#### References

1. Warburg and Christian, (1942) Biochem. Z. 310, 384-421.
2. Kalb and Bernlohr, (1977) Anal. Biochem. 82, 362-371.

## Trace Sample Measurements

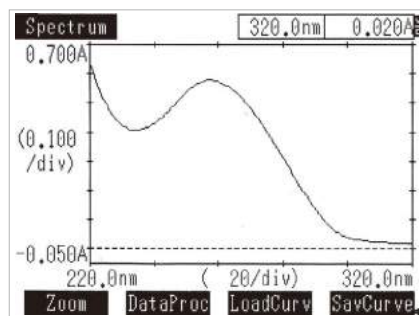

Spectral measurements of a 100  $\mu$ L of dsDNA sample were performed using a supermicro cell holder. A conventional square cell with a path length of 10 mm requires approx. 3.5 mL of sample. However, a supermicro cell allows measurements with a 100  $\mu$ L to 200  $\mu$ L sample.

Program: Spectrum

Accessories: supermicro cell, supermicro cell holder, and sample compartment unit



Supermicro Cell Holder



Supermicro Cell

## Culture Fluid Turbidity Measurements

If the photometric function is used, dilution and other coefficients can be calculated automatically. In addition, measure microbial counts as is in test tubes using the test tube holder (special order product).

Program: Photometric

Accessory: Test tube holder

The sample compartment unit (P/N 206-60184-07) is separately required.



Test Tube Holder

## Chemicals

A wealth of accessories enables analysis of a variety of samples, including liquids and films. In addition, the UV-1280 can accommodate both spectral and quantitation measurements.

### Transmittance Measurements of Films

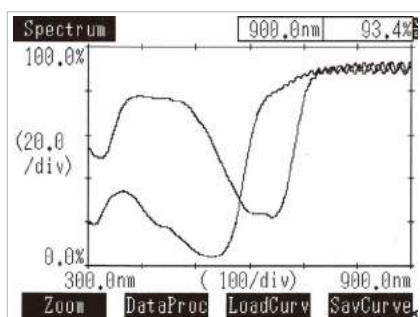

This is an example of a spectral measurement of colored cellophane. Absorption by the red colored cellophane is evident at around 530 nm, and by the blue colored cellophane at around 650 nm.

Program: Spectrum  
Accessories: sample compartment unit and film holder



Film Holder

## Foods

Perform single wavelength measurements with a single touch of a button. Coefficients can also be calculated simultaneously. The data is exported to a CSV file, simplifying subsequent analysis. In addition to quantitation using one or two wavelengths, a multi-component quantitation function using multiple peaks is also included as standard.

### Color Value Measurements of Food Dyes

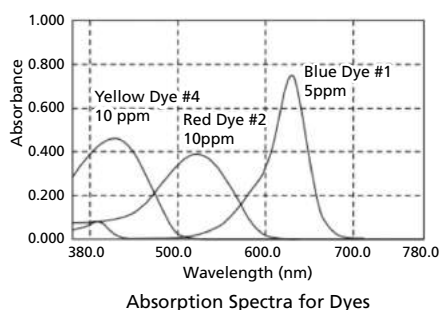

Dye concentrations (color values) were determined by measuring the absorbance. Conventionally, the color value is determined by measuring the absorbance at the wavelength of maximum absorption in the visible range in the solution with the food coloring, and then converting the value to the absorbance for a 10 w/v% solution (E10 % 1 cm).

Program: Spectrum  
Accessory: 10-mm standard cell

#### Measurement Results

Sample Name	Collected Material (g)	F	Cell Used	$\lambda_{max}$	ABS	Color Value
Blue Dye #1	0.500	1000	STDCELL	629.5	0.7488	14976
Red Dye #2	0.100	100	STDCELL	521.5	0.3889	3889
Yellow Dye #4	0.100	100	STDCELL	426.5	0.4611	4611

$$\text{Color Value} = \frac{10 \times A \times F}{\text{Quantity of sample collected (g)}}$$

F: Dilution rate to adjust the measured absorbance so that it falls in a range between 0.3 and 0.7  
A: Measured absorbance

# Applications

## Environmental

Easily perform both transmitted light turbidity measurements and RoHS hexavalent chromium quantitation with a simple quantitation program. In addition to the standard sample chamber for 10-mm cells, you can use a long path length cell for measuring low concentration solutions, or a sipper unit that does not require a cell.

### Transmitted Light Turbidity Measurement as per JIS K0101 "Testing Methods for Industrial Water"

Standard Table			660.0nm 0.631A	
No.	Conc.	Abs	No.	Abs
1	20.000	0.035	1	
2	50.000	0.096		
3	100.00	0.170		
4	200.00	0.331		
5	400.00	0.645		

Press START to Measure.

ClbCurve Change Delete Add

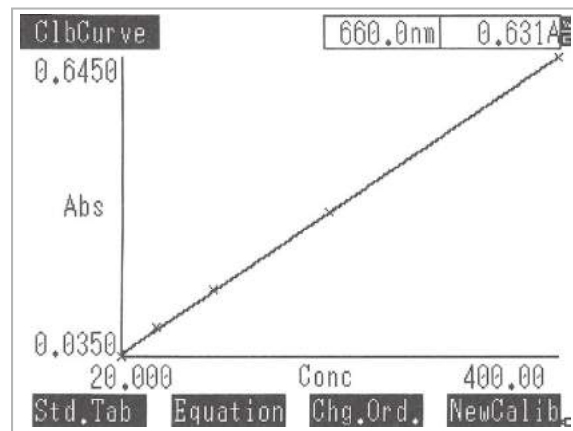

In accordance with JIS K0101, a standard formazin solution was prepared. The absorbance at 660 nm was measured, and a calibration curve was created. A rectangular cell with a 50 mm path length is used for turbidities of 4 to 80 degrees, and a square cell with a 10 mm path length for 20 to 400 degrees.

$$\begin{aligned} \text{Abs} &= K1C + K0 \\ K1 &= 1.5908\text{e-}03 \\ K0 &= 1.0420\text{e-}02 \\ r^2 &= 0.9996 \end{aligned}$$

Program: Quantitation

Accessories: sample compartment unit, long-path rectangular cell holder, and a 50-mm rectangular cell

# Multi-Sample Measurements

## Measurements Using Multiple Cells

When measuring multiple samples under the same conditions, it is convenient to use the four-cell sample compartment unit and the multi-cell sample compartment, which are capable of automatically measuring multiple positioned cells. A 4-cell-type universal rectangular cell holder is also available to accommodate long-path rectangular cells.

Accessories: various cells, four-cell sample compartment unit, multi-cell sample compartment, and the 4-cell-type universal rectangular cell holder

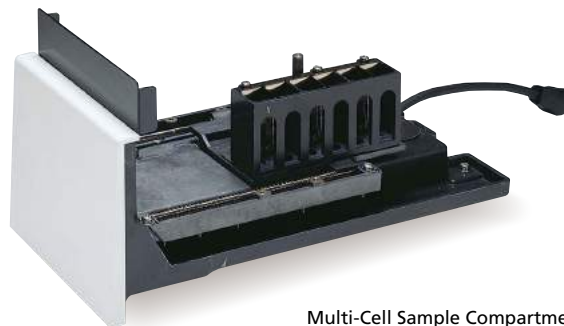

Multi-Cell Sample Compartment

## Multi-Sample Measurements without Cells

Using a sipper allows measurements without transferring samples to cells. Both a peristaltic pump type sipper unit and a syringe sipper with a syringe pump system are available. With the sipper unit 160C and the syringe sipper model CN, the temperature can be controlled via a circular flow of water at a constant temperature. Combining the instrument with an auto sample allows automatic measurements from up to 100 test tubes. A test tube holder (available by special order) allows performing measurements by placing the test tubes directly in the sample chamber instead of using cells. The measurements can be performed with the test tube lids left sealed, which is convenient for measurements of culture fluids.

Accessories: various sipper units, syringe sipper, auto sample changer, and test tube holder (cells not required)



Syringe Sipper

# Accessories

## Film Holder

P/N 204-58909

Used in transmittance measurement of thin samples such as films and filters. Holds thin samples, such as films and filters, for analysis.

Sample Size

- Minimum: 16 (W) × 32 (H) mm
- Maximum: 80 (W) × 40 (H) × 20 (t) mm

**Note** The sample compartment unit (P/N 206-60184-07) is required.



## Didimium Filter

P/N 202-30242-09

These are used for operational checks of the instrument.



## Holmium Filter

P/N 202-30242-05

These are used for operational checks of the instrument.



## Four-Cell Sample Compartment Unit

P/N 206-23670-91

Accommodates 4-cell holders of various types.

- Incorporates a 4-cell holder for a standard cell.



## Sample Compartment Unit

P/N 206-60184-07

This is needed when using the various cell holders (micro flow cell, long-path rectangular cell, cylindrical cell, film holder, constant-temperature cell, etc.).



## Multi-Cell Sample Compartment

P/N 206-60605-42

Holds up to six standard cells on the sample side. No temperature control capability.

- Number of cells: 6 on the sample side

**Note** Rectangular cells are not included. Purchase them separately.

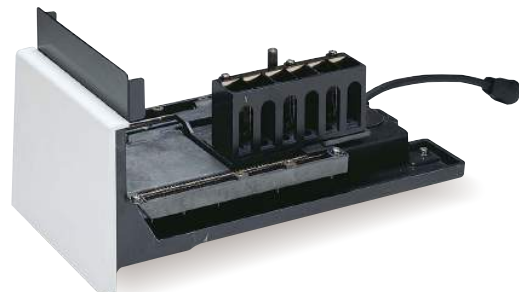

## Spacers for Short-Path Cells

P/N 204-21473-XX

- If samples are too concentrated and cannot be measured with the standard 10-mm path cell, they can be measured without dilution using a short-path cell.
- Spacers are available for 1 mm, 2 mm, and 5 mm path cells. As shown in the figure at right, the spacer is mounted in a standard rectangular cell holder in conjunction with a short-path cell.

P/N	Optical Path Length
204-21473-03	1mm
204-21473-01	2mm
204-21473-02	5mm

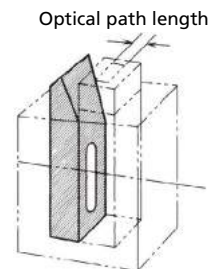

## Universal Rectangular Cell Holder, Four-Cell Type

P/N 204-27208

Holds rectangular cells with an optical path length of 10, 20, 30, or 50 mm.

**Note**

The four-cell sample compartment unit (P/N 206-23670-91) is required. When a long-path rectangular cell is used on the reference side, its holder (P/N 204-28720) is additionally required.



## Reference-Side Long-Path Rectangular Cell Holder

P/N 204-28720

If using a 4-cell-type universal rectangular cell holder, use a reference-side cell holder if necessary.



## Four-Cell Type 50-mm Long-Path Rectangular Cell Holder

P/N 206-65898-41

This is attached instead of the six-cell holder, enabling placement of up to four 50-mm long-path rectangular cells. Cells are switched automatically in synch with the measurements as with a multi-cell.

**Applicable Cell**

Rectangular cell (50 mm path length); P/N: 200-34944

**Note**

The multi-cell sample compartment (P/N 206-60605-02) is required.



## Long-Path Rectangular Cell Holder

P/N 204-23118-01

Holds rectangular cells with an optical path length of 10, 20, 30, or 50 mm.

**Note**

The sample compartment unit (P/N 206-60184-07) is required. The 100 mm rectangular cell cannot be used.



## Long-Path Rectangular Cell Holder (For Wide Cells)

P/N 206-69421

Typically, only long-path rectangular cells up to 50 mm path length can be used, due to the restriction of beam width. However, this holder, designed while taking beam width into account, allows using cells with a longer path length. With special cells, path lengths of 100 mm can be used.

**Note** The sample compartment unit (P/N 206-60184-07) is required.

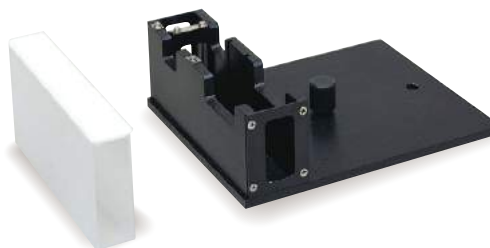

## Long-Path Rectangular Cell (Wide Type)

This is a glass 15 mm wide long-path rectangular cell, which is wider than the conventional 10 mm wide cell. A special lid is provided, which is effective in preventing the sample from spilling out of the cell.

Optical Path Length	P/N	Special Lid P/N
10mm	200-66599-01	200-66600-01
33mm	200-66599-02	200-66600-02
50mm	200-66599-03	200-66600-03
100mm	200-66599-04	200-66600-04

## Cylindrical Cell Holder

P/N 204-06216-02

Holds two cylindrical cells with an optical path length of 10, 20, 50, or 100 mm.

**Note** The sample compartment unit (P/N 206-60184-07) is required.



## Super Micro Cell Holder

P/N 206-14334-01

Holds super micro cells for measurement of extremely small volume samples. The cell height is adjustable, and the required sample volume can be adjusted in the range of 100 to 200  $\mu$ L, depending on the type of black cell used.

Applicable cells: (7), (7)', and (8) in the list of cells on page XXX.

Mask: Choice of 1.5 (W)  $\times$  1 (H) mm or 1.5 (W)  $\times$  3 (H) mm

**Note**

- The sample compartment unit (P/N 206-60184-07) is required.
- The quantity of light passing through the cell is reduced, so it may not be possible to satisfy the optical specifications of the instrument.

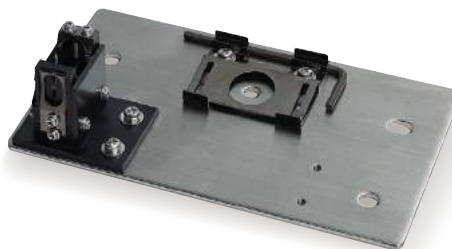



## Micro Cell Mask for Six-Cell Holder

P/N 206-66828

This mask is used to narrow the beam width when micro cells are placed in the multi-cell sample compartment for measurement.

### Applicable Cell

- Semi-micro cell (10 mm path length)  
P/N 200-66501 (silica)  
P/N 200-66501-01 (glass)
- Semi-micro black cell (10 mm path length)  
P/N 200-66551 (silica)

**Note** The quantity of light passing through the cell is reduced, so it may not be possible to satisfy the optical specifications of the instrument.



## Constant-Temperature Cell Holder

P/N 202-30858-04

Maintains a sample cell and reference cell at a desired, uniform temperature by circulating constant-temperature water.

- Temperature range: 5 °C to 90 °C  
(depends on the performance of the constant-temperature water circulator)
- Cell holder: Accepts a pair of standard cells.
- Connecting joint outer diameter: 6 mm and 9 mm (two levels)

**Note** The sample compartment unit (P/N 206-60184-07) is required.

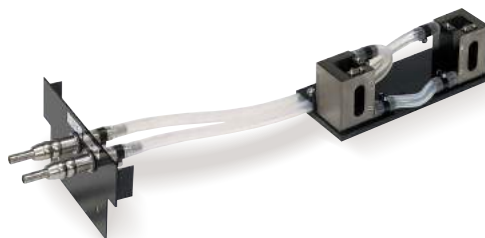

## Constant-Temperature Four-Cell Holder

P/N 204-27206-02

Maintains four sample cells and a reference cell at a desired, uniform temperature by circulating constant-temperature water.

- Temperature range: 5 °C to 90 °C  
(depends on the performance of the constant-temperature water circulator)
- Cell holder: Accepts four standard cells plus a reference cell.
- Connecting joint outer diameter: 9 mm

**Note** The four-cell sample compartment unit (P/N 206-23670-91) is required.



## CPS-100 Cell Positioner, Thermoelectrically Temperature Controlled

P/N 206-29500-42/43/58

This attachment permits measurement of up to six sample cells under constant-temperature conditions.

- Number of cells: 6 on the sample side (temperature-controlled)
- Temperature control range: 16 °C to 60 °C
- Temperature display accuracy (difference from the true value):  $\pm 0.5$  °C
- Temperature control precision (variation of temperature):  $\pm 0.1$  °C
- Ambient temperature: 15 °C to 35 °C

**Note** A standard cell (P/N 200-34442) is not included. A USB adapter CPS (P/N 206-25234-91) is required. Purchase them separately.



## TCC-100 Thermoelectrically Temperature-Controlled Cell Holder

P/N 206-29510-42/43/44

Uses Peltier effect for controlling the sample and reference temperature, so no thermostated bath or cooling water is required.

- Number of cells: 1 on the sample side (temperature-controlled)
- Temperature control range: 7 °C to 60 °C
- Temperature display accuracy (difference from the true value):  $\pm 0.5$  °C
- Temperature control precision (variation of temperature):  $\pm 0.1$  °C

**Note** A standard cell (P/N 200-34442) is not included. Purchase it separately.



## NTT-2200P Constant-Temperature Water Circulator

P/N 208-97263

Circulates temperature-controlled water to a constant-temperature cell holder.

- Temperature range: Ambient +15 °C to 80 °C
- Temperature control precision:  $\pm 0.05$  °C or more
- Maximum pumping rate: 27/31 L/min, 9.5/13 m (50/60 Hz)
- External circulation nozzle: 10.5 mm OD (both outlet and return)
- Tank capacity: About 10 L (9 L during use)
- Safety features: Detection of over-temperature of upper or lower limits; detection of heater wire malfunction; protection from heating too little circulating water; detection of sensor malfunction; independent over-heat protection; over-current circuit protector
- Standard accessories: Lid with handles; rubber hose (4 m; inner diameter: 8 mm; outer diameter: 12 mm; quantity: 1); hose clamps (4 pcs); instruction manual (Japanese and English)
- Dimensions: W270 × H560 × D400 mm
- Power requirements: 100 VAC, 1,250 VA, with 1.7-m power cord and grounded plug



## Sipper Unit 160L (Standard Sipper)

P/N 206-23790-91

## Sipper Unit 160T (Triple-Pass Sipper)

P/N 206-23790-92

## Sipper Unit 160C (Constant-Temperature Sipper)

P/N 206-23790-53

## Sipper Unit 160U (Supermicro Sipper)

P/N 206-23790-94

Four sipper units with different flow cell types are available. The stepping motor-driven peristaltic pump ensures reliable and smooth aspiration of sample solution.

(Direct driving is possible from the UV-1280 so no interface is required.)

### Note

- The use of a solenoid valve (fluoropolymer) (P/N 204-06599-01) and the SWA-2 sample waste unit (P/N 206-23820-91) are recommended when strong acids, strong alkalis, or organic solvents are to be measured.
- The quantity of light passing through the cell is reduced, so it may not be possible to satisfy the optical specifications of the instrument.

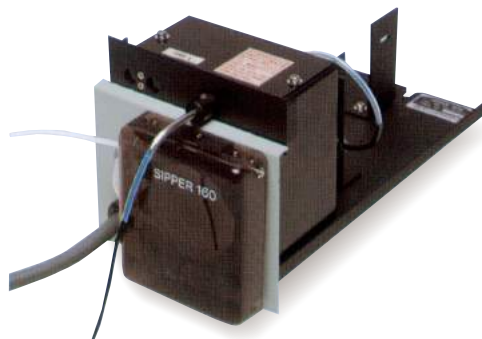

### Standard Sample Volume

160L	2.0mL
160T	1.5mL
160C	2.5mL
160U	0.5mL

## Syringe Sipper

Model	P/N
Syringe Sipper N (Normal temperature type)	206-23890-51
Syringe Sipper CN (Constant temperature, water circulator type)	206-23890-92

**Note** Flow cells available separately. Choose from the recommended flow cells listed below.

Recommended Flow Cells				
Model	P/N	Optical Path Length	Dimensions of Aperture	Standard Required Sample Volume
Rectangular (micro)	208-92113	10mm	ø3mm	1.0mL
Rectangular (semi-micro)	208-92005	10mm	H11xW3.5mm	5.0mL

The sipper unit employs a syringe-pump system. The liquid-contact surfaces are composed of fluoropolymer, glass, or quartz, imparting excellent chemical resistance and ease of maintenance, and allowing measurement of almost any sample type. Further, the extremely high repeatability of sipping volume (repeat precision:  $\pm 0.03$  mL) makes it ideal when performance validation is required.



- The type of flow cell can be selected in accordance with the application.
- The flow cell can be changed independently for excellent ease of maintenance.
- Circulated-water temperature range: ambient to 60 °C (CN type)

### Note

- The sample compartment unit (P/N 206-60184-07) is required.
- If a rectangular flow cell (micro) is used, attaching mask R (206-88679) to the reference cell holder is recommended to balance the light intensity.

## ASC-5 Auto Sample Changer

P/N 206-23810-92/93

Combine with a Sipper 160 to build an automated multisample spectrophotometry system.

- The aspirating nozzle is programmed to move in the X, Y, and Z (vertical) directions.
- Up to 8 sets of operational parameters, including the sizes of racks and the numbers of test tubes, may be memorized in the battery back-up protected files.
- Up to 100 test tubes may be set together on the rack.

**Note** A commercially available test tube stand, with a footprint smaller than 220 × 220 mm, is applicable.



## 10 mm Micro Flow-Thru Cell with Holder

P/N 204-06222-40

## 5 mm Micro Flow-Thru Cell with Holder

P/N 204-06222-01

Used for the continuous analysis of samples such as the liquids produced by column chromatography.

- Inner diameter of tube: 1 or 2 mm

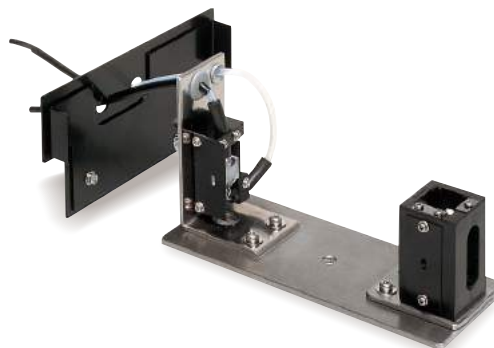

P/N	Optical Path Length	Volume
204-06222	10mm	0.3mL
204-06222-01	5mm	0.15mL

## Front Panel with Holes

P/N 204-27588-03

Allows the tubes of a flow cell, for example, to be connected through the front panel of the instrument.

**Note** The sample compartment unit (P/N 206-60184-07) is required.



## UV Automated System Connection Kit

P/N 206-80880-02

This enables connection with the Gilson GX-271 Liquid Handler. The liquid handler automatically performs a variety of pretreatments, including sample dispensing and dilution, and the addition of reagents. This connection kit interfaces the spectrophotometer and the liquid handler.

- The connection kit consists of a flow cell unit and connection cable.

**Note** The sample compartment unit (P/N 206-60184-07) is required.

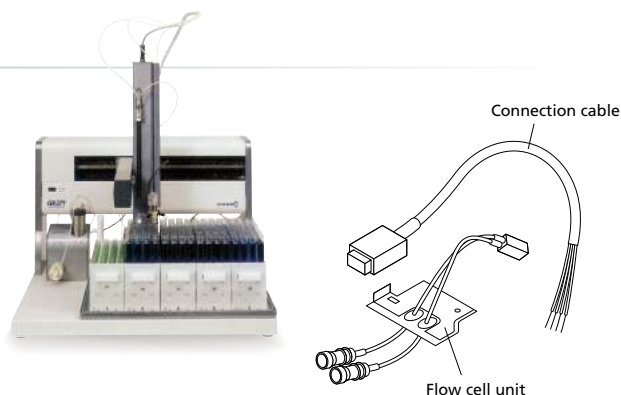

## Cells

Description	Optical Path (L)	Required Sample Volume	Type	Fused Silica (S)	Glass (G)
Rectangular cell	10mm	2.5 to 4.0mL	①	200-34442	200-34565
	20mm	5.0 to 8.0mL	⑥	200-34446	200-34446-01
	50mm	12.5 to 20.0mL		200-34944	200-34944-01
Rectangular cell with stopper	10mm	2.5 to 4.0mL	②	200-34444	200-34444-01
Semi-micro cell	10mm	1.0 to 1.6mL	③ <sup>*1</sup>	200-66501	200-66501-01
Semi-micro black cell	10mm	1.0 to 1.6mL	③' <sup>*1</sup>	200-66551	—
Super Micro black cell	5mm	50 to 100μL	⑦' <sup>*2</sup>	208-92116	—
	10mm	100 to 200μL	⑦ <sup>*2</sup>	200-66578-11	—
Micro black cell	10mm	50 to 400μL	⑧ <sup>*2</sup>	200-66578-12	—
Cylindrical cell	10mm	3.8mL	④	200-34448 (silica window)	200-34448-01 (glass window)
	20mm	7.6mL		200-34472 (silica window)	200-34472-01 (glass window)
	50mm	19.0mL		200-34473-01 (silica window)	200-34473-03 (glass window)
	100mm	38.0mL		200-34473-02 (silica window)	200-34473-04 (glass window)
Short-path cell	1mm	0.3 to 0.4mL	⑤	200-34660-01	200-34662-01
	2mm	0.5 to 0.8mL		200-34655	200-34662-11
	5mm	1.3 to 2.0mL		200-34449	200-34449-01

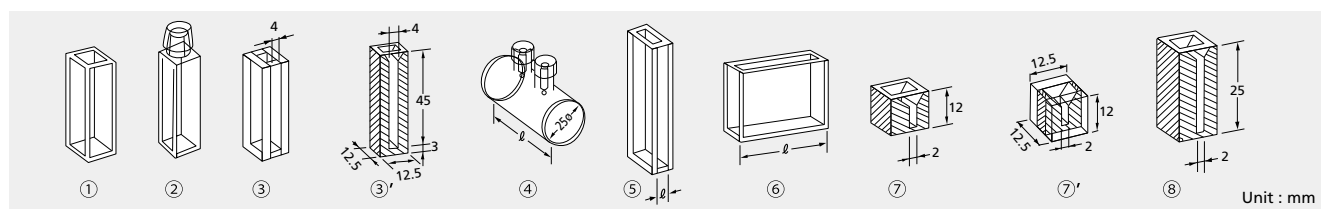

**Note** \*1 The micro cell mask for six-cell holder (206-66828) is required when Multi-Cell Sample Compartment is used.  
\*2 The super Micro cell holder (206-14334-01) is required.

## MPU Screen Copy Printer

P/N 206-26007-92/93

Prints hard copies of screens, including numeric data. Numerical data is printed after each measurement. Spectra, kinetic reaction data, and quantitation calibration curves displayed on the screen are output in the screen print. A hard copy can be printed at any time, making it simple to record measurement parameters.

A cable for connecting to the UV-1800 is included as an accessory.

- Dimensions: W168 × D155 × H87 mm
- Weight: 820 g (without the adapter)
- Thermal paper (10 rolls; P/N 088-58907-04)



## UV-1800

### ■ High Resolution

In addition to achieving a resolution of 1 nm, by using a monochromator with a Czerny-Turner mounting, the UV-1800 also features a compact, bright optical system.

### ■ Space Reductions

The dimensions of the UV-1800 are W450 mm x D490 mm, which allows installation in tight spaces.

### ■ Improved Operability

The UV-1800 is available as either a stand-alone instrument or a PC-controlled instrument. In addition, it is USB-flash-drive ready, which enables users to save measurement data to highly versatile USB flash drives, and perform data analysis and printing using a PC.



Wavelength range	190 to 1,100 nm
Spectral bandwidth	1 nm (190 to 1,100 nm)
Stray light	0.02 % or less at 220 nm and 340 nm
	1.0 % or less at 198 nm
Photometric system	Double beam optics
Photometric range	Absorbance: -4 to 4 Abs



Shimadzu Corporation

[www.shimadzu.com/an/](http://www.shimadzu.com/an/)

Company names, product/service names and logos used in this publication are trademarks and trade names of Shimadzu Corporation or its affiliates, whether or not they are used with trademark symbol "TM" or "®". Third-party trademarks and trade names may be used in this publication to refer to either the entities or their products/services. Shimadzu disclaims any proprietary interest in trademarks and trade names other than its own.

For Research Use Only. Not for use in diagnostic procedures.

The contents of this publication are provided to you "as is" without warranty of any kind, and are subject to change without notice. Shimadzu does not assume any responsibility or liability for any damage, whether direct or indirect, relating to the use of this publication.

© Shimadzu Corporation, 2014

Printed in Japan 3655-06403-50AIT