

Sit

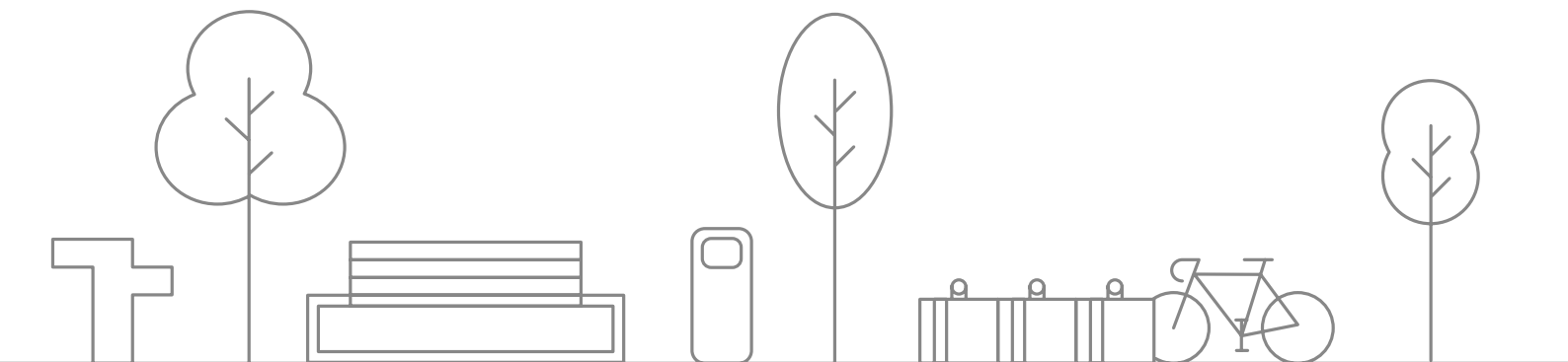

SiT

Mobiliário Urbano . Urban Furniture . Mobilier Urbain

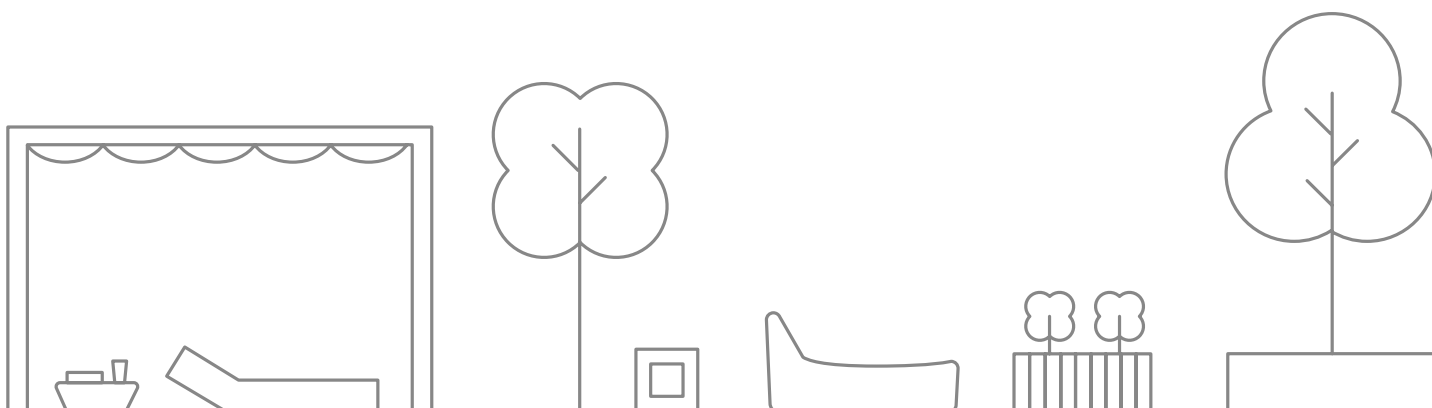

A SIT Urban Design apresenta neste catálogo uma coleção de mobiliário urbano composta por peças idealizadas para espaços ao ar livre. De arquitetura contemporânea todas as formas são simples e minimalistas.

A integração destas peças em espaços verdes proporciona o encontro das pessoas com o meio envolvente, animando a vida das comunidades.

Todos os elementos aqui descritos têm como mais-valias características de funcionalidade, resistência e durabilidade aliadas a uma reduzida manutenção.

In this catalogue Sit Urban Design presents a collection of urban furniture made by elements thought for open spaces. With a contemporary architecture, all elements show simple and minimalist design.

Integrating these urban elements in green spaces provides better surroundings to its community.

All urban elements described in this catalogue feature high functionality, resistance and durability allied to low-maintenance.

Sit Urban Design présente dans ce catalogue des collections de mobilier urbain composées de pièces idéalisées pour des espaces à l'air libre. D'architecture contemporaine, toutes les formes sont simples et minimalistes.

L'intégration de ces pièces dans des espaces verts permet la rencontre des personnes avec l'environnement animant la vie des communautés.

Tous les éléments décrits ci-dessus ont pour plus-values des caractéristiques de fonctionnalité, de résistance et de durabilité, alliées à une maintenance réduite.

FORM ref. 540

BANCO COM COSTAS ALTAS . betão
 BENCH WITH TALL BACKREST . concrete
 BANC À DOSSIER ÉLEVÉ . béton . 275Kg.

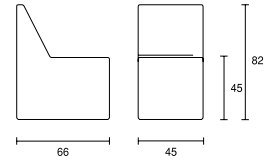

FORM ref. 541

CUBO . betão
 CUBE . concrete
 CUBE . béton . 160Kg.

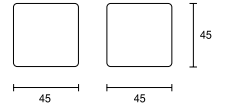

FORM ref. 542

BANCO . betão
 BENCH . concrete
 BANC . béton . 360Kg.

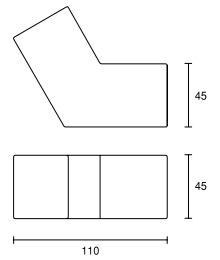

FORM ref. 543

BANCO COM COSTAS . betão
 BENCH WITH BACKREST . concrete
 BANC À DOSSIER . béton . 390Kg.

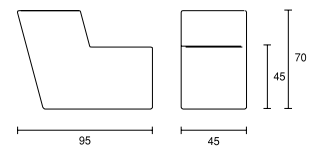

FORM ref. 543.FL

BANCO COM COSTAS E FLOREIRA . betão
 BENCH WITH BACKREST AND PLANTER . concrete
 BANC À DOSSIER ET BAC À FLEURS . béton . 340Kg.

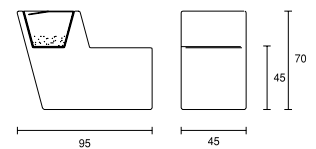

FORM ref. 544

SOFÁ INDIVIDUAL . betão
 INDIVIDUAL SOFA . concrete
 CANAPÉ INDIVIDUEL . béton . 360Kg.

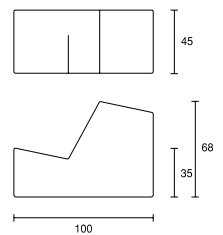

FORM ref. 545

CINZEIRO . betão + metal lacado
 ASHTRAY . concrete + lacquered metal
 CENDRIER . béton + métal laquée . 120Kg.

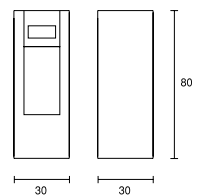

FORM ref. 546

BEBEDOURO . betão
 DRINKING FOUNTAIN . concrete
 ABREUVOIR . béton . 250Kg.

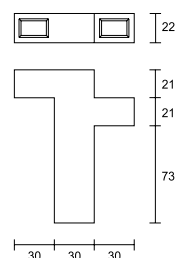

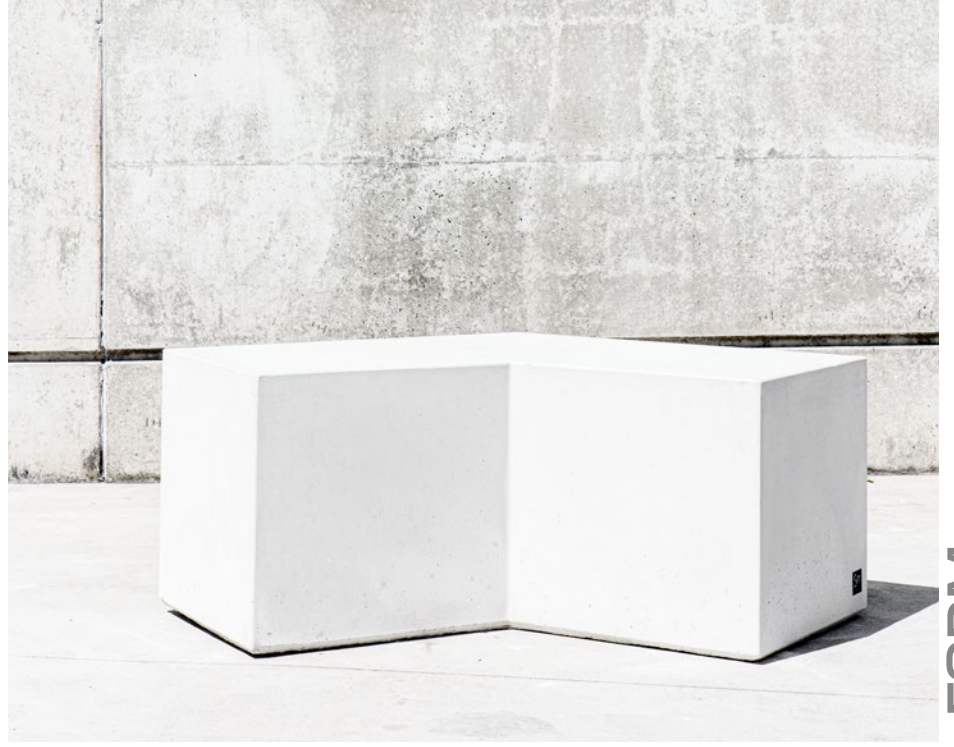

FORM



OUTLINE ref. 530

BANCO . betão + madeira
 BENCH . concrete + wood
 BANC . béton + bois . 265Kg.

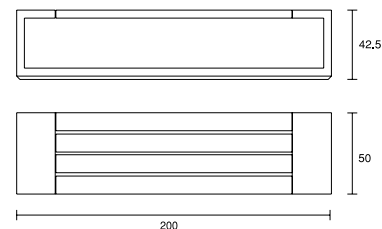

OUTLINE ref. 531

BANCO COM COSTAS . betão + madeira
 BENCH WITH BACKREST . concrete + wood
 BANC À DOSSIER . béton + bois . 285Kg.

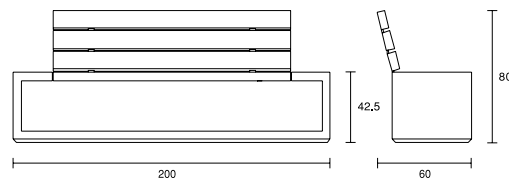

OUTLINE ref. 537

BANCO INDIVIDUAL . betão
 INDIVIDUAL BENCH . concrete
 BANC INDIVIDUEL . béton . 75Kg.

OUTLINE ref. 537.L

BANCO INDIVIDUAL COM ILUMINAÇÃO . betão
 INDIVIDUAL BENCH WITH LIGHT . concrete
 BANC INDIVIDUEL AVEC ÉCLAIRAGE . béton . 75Kg.

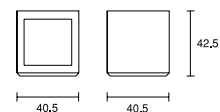

OUTLINE ref. 532.NC

MESA DE APOIO . cortiça natural
 LOW TABLE . natural cork
 TABLE BASSE . liège . 15Kg.

OUTLINE ref. 534.BC

MESA DE APOIO . cortiça escura
 LOW TABLE . black cork
 TABLE BASSE . liège noir . 15Kg.

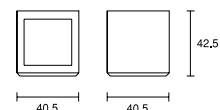

OUTLINE ref. 532.CXLC

PAPELEIRA . betão + caixa metálica lacada
 LITTER BIN . concrete + lacquered metal box
 CORBEILLE . béton + boîte métallique laquée. 130Kg.

OUTLINE ref. 532.CXN304

PAPELEIRA . betão + caixa em inox 304
 LITTER BIN . concrete + 304 stainless steel box
 CORBEILLE . béton + boîte en inox 304 . 130Kg.

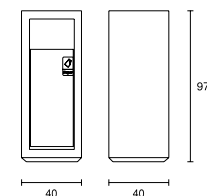

OUTLINE ref. 532.CXMD

PAPELEIRA . betão + caixa de madeira
 LITTER BIN . concrete + wood box
 CORBEILLE . béton + boîte tapissée de bois . 130Kg.

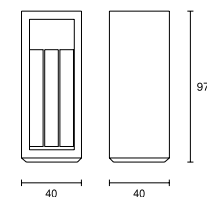

OUTLINE ref. 532.ECO

ECOPONTO . betão + caixa metálica lacada
 RECYCLING BIN . concrete + lacquered metal box
 ÉCOPOINT . béton + boîte métallique laquée . 390Kg.

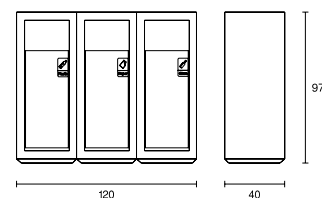

OUTLINE ref. 535

DISSUASOR . betão
 BOLLARD . concrete
 BORN DE DISSUASION . béton . 50Kg.

OUTLINE ref. 535.L

DISSUASOR COM ILUMINAÇÃO . betão
 BOLLARD WITH LIGHT . concrete
 BORN DE DISSUASION AVEC ÉCLAIRAGE . béton . 50Kg.

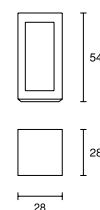



OUTLINE



MASTERLAYER ref. 501

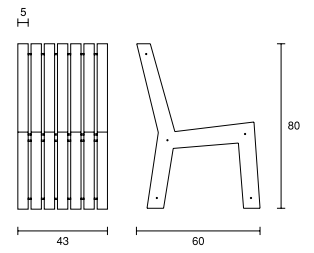

CADEIRA . betão reforçado com fibra
 CHAIR . fibre reinforced concrete
 CHAISE . béton renforcé avec de la fibre . 75Kg.

MASTERLAYER ref. 502

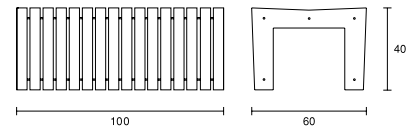

BANCO . betão reforçado com fibra
 BENCH . fibre reinforced concrete
 BANC . béton renforcé avec de la fibre . 145Kg.

MASTERLAYER ref. 503

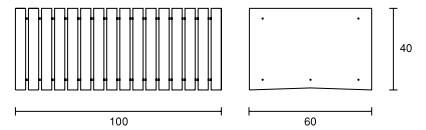

FLOREIRA . betão reforçado com fibra
 PLANTER . fibre reinforced concrete
 BAC À FLEURS . béton renforcé avec de la fibre . 195Kg.

MASTERLAYER ref. 504

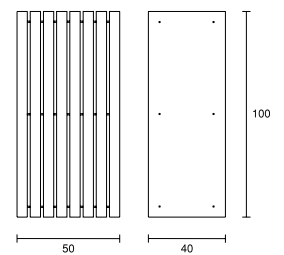

PAPELEIRA . betão reforçado com fibra
 LITTER BIN . fibre reinforced concrete
 CORBEILLE . béton renforcé avec de la fibre . 165Kg.

MASTERLAYER ref. 505

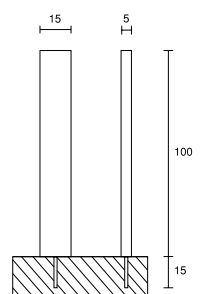

DISSUASOR . betão reforçado com fibra
 BOLLARD . fibre reinforced concrete
 BORNE DE DISSUASION . béton renforcé avec de la fibre . 15Kg.



MASTERLAYER

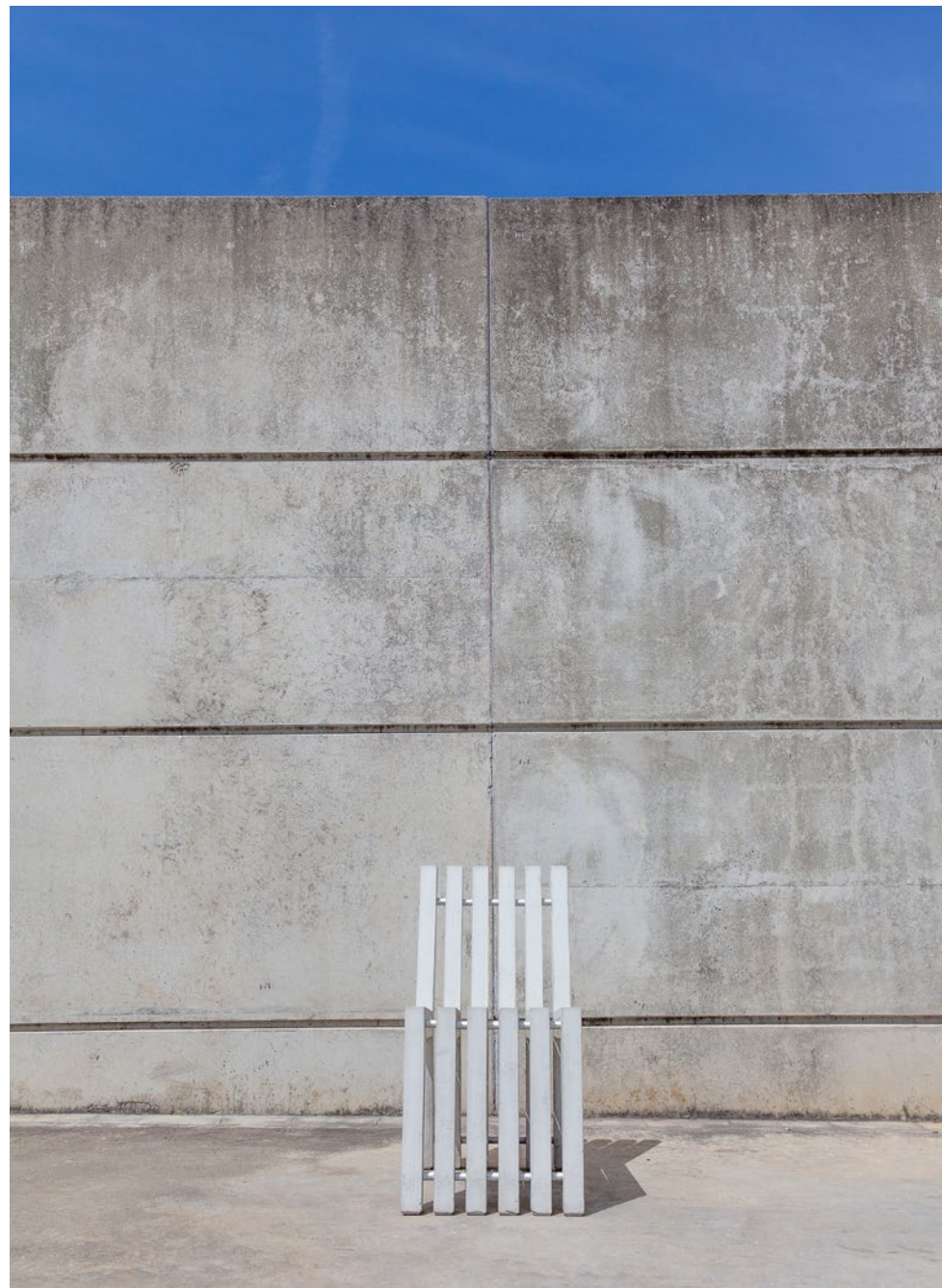

KID ref. 410

MESA . betão
TABLE . concrete
TABLE . béton . 450Kg.

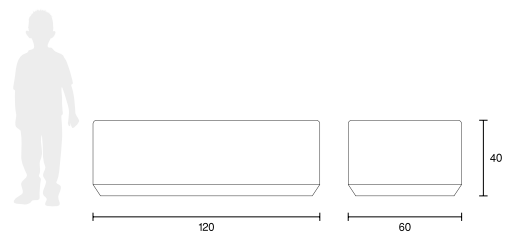

KID ref. 411

BANCO L . betão
L BENCH . concrete
BANC L . béton . 380Kg.

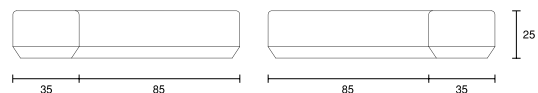

KID ref. 412

BANCO . betão
BENCH . concrete
BANC . béton . 220Kg.

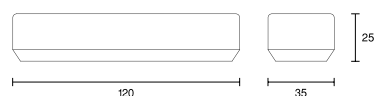

KID ref. 413

BANCO INDIVIDUAL . betão
INDIVIDUAL BENCH . concrete
BANC INDIVIDUEL . béton . 110Kg.

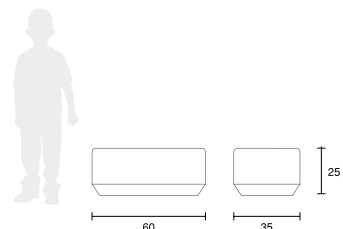

KID ref. 414 - BONE

BANCO . betão
BENCH . concrete
BANC . béton . 250Kg.

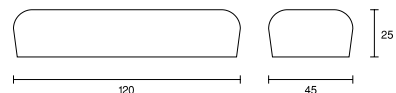

KID ref. 415.CXLC

PAPELEIRA . betão reforçado com fibra + caixa metálica lacada
LITTER BIN . fibre reinforced concrete + lacquered metal box
PAPELERA . béton renforcé avec de la fibre + boîte métallique laquée . 100Kg.

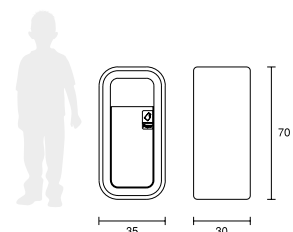

KID ref. 415.ECO

ECOPONTO . betão reforçado com fibra + caixa metálica lacada
RECYCLING BIN . fibre reinforced concrete + lacquered metal box
ÉCOPOINT . béton renforcé avec de la fibre + boîte métallique laquée . 300Kg.

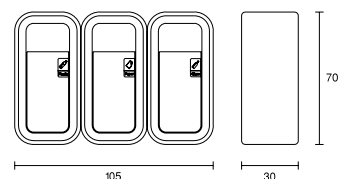

KID ref. 416

BEBEDOURO . betão
DRINKING FOUNTAIN . concrete
ABREUVOIR . béton . 165Kg.

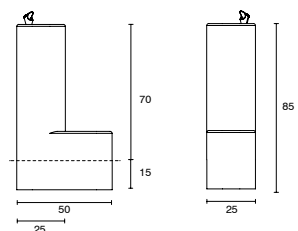



KID



WADE ref. 620

BANCO COM COSTAS . ferro + madeira
 BENCH WITH BACKREST . iron + wood
 BANC À DOSSIER . fer + bois . 76Kg.

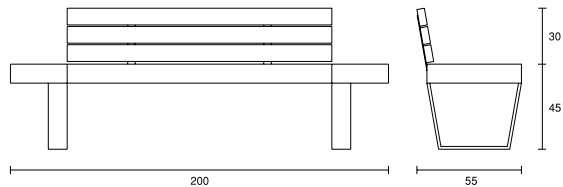

WADE ref. 621

PAPELEIRA . ferro + madeira
 LITTER BIN . iron + wood
 CORBEILLE . fer + bois . 20Kg.

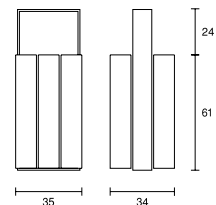

WADE ref. 621.C

PAPELEIRA COBERTA . ferro + madeira
 COVERED LITTER BIN . iron + wood
 CORBEILLE COUVERT . fer + bois . 21Kg.

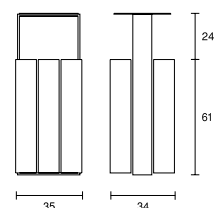

WADE ref. 622

FLOREIRA . ferro + madeira
 PLANTER . iron + wood
 BAC À FLEURS . fer + bois . 46Kg.

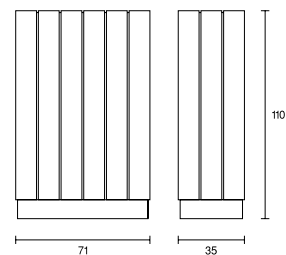

WADE ref. 623

FLOREIRA . ferro + madeira
 PLANTER . iron + wood
 BAC À FLEURS . fer + bois . 39Kg.

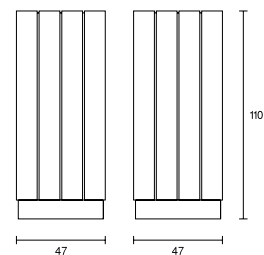

WADE ref. 624

SUPORTE DE BICICLETAS . ferro
 BICYCLE RACK . iron
 PORTE-VÉLOS . fer . 32Kg.

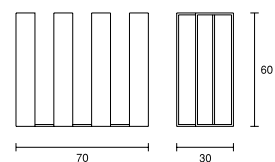

WADE ref. 625

CALDEIRA . ferro
 TREE SURROUNDS . iron
 GRILLE D'ARBRE . fer . 132Kg.

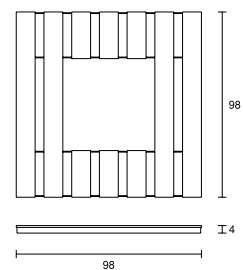



WADE



MOLD ref. 560

BANCO . betão
BENCH . concrete
BANC . béton . 230Kg.

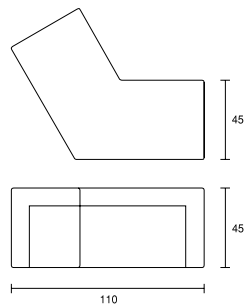

MOLD ref. 561

BANCO FLOREIRA . betão
PLANTER BENCH . concrete
BANC BAC À FLEURS . béton . 290Kg.

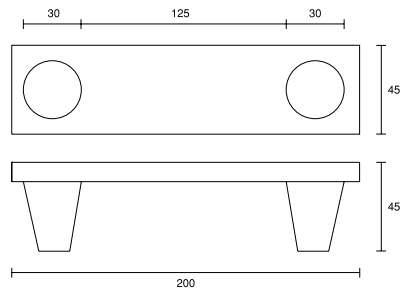

MOLD ref. 562

SOFÁ . betão
SOFA . concrete
CANAPÉ . béton . 240Kg.

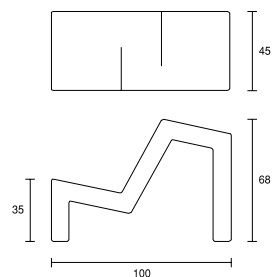



SKEW ref. 610

BANCO . ferro + madeira
 BENCH . iron + wood
 BANC . fer + bois . 92Kg.

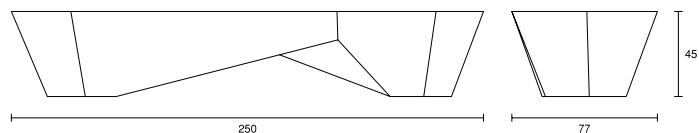

SKEW ref. 611

BANCO INDIVIDUAL . ferro + madeira
 INDIVIDUAL BENCH . iron + wood
 BANC INDIVIDUEL . fer + bois . 36Kg.

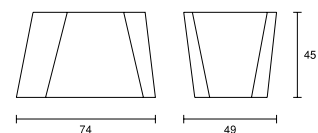

SKEW ref. 612

PAPELEIRA . ferro + madeira
 LITTER BIN . iron + wood
 CORBEILLE . fer + bois . 52Kg.

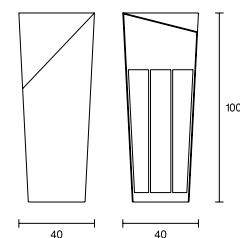

SKEW ref. 613

FLOREIRA . ferro
 PLANTER . iron
 BAC À FLEURS . fer . 48Kg.

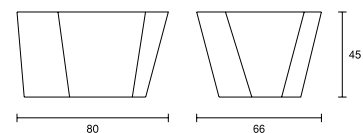

SKEW ref. 614

FLOREIRA . ferro
 PLANTER . iron
 BAC À FLEURS . fer . 39Kg.

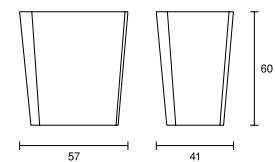

SKEW ref. 615

CALDEIRA . ferro
 TREE SURROUNDS . iron
 GRILLE D'ARBRE . fer . 32Kg.

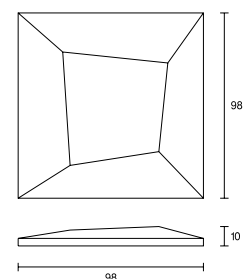



SKEW



VIDA ref. 570

BANCO INDIVIDUAL . betão
 INDIVIDUAL BENCH . concrete
 BANC INDIVIDUEL . béton . 95Kg.

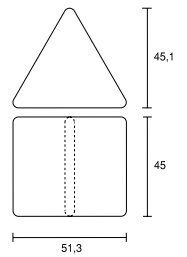

VIDA ref. 570.L

BANCO INDIVIDUAL COM ILUMINAÇÃO . betão
 INDIVIDUAL BENCH WITH LIGHT . concrete
 BANC INDIVIDUEL AVEC ÉCLAIRAGE . béton . 95Kg.

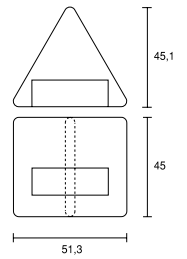

VIDA ref. 571

FLOREIRA . betão
 PLANTER . concrete
 BAC À FLEURS . béton . 95Kg.

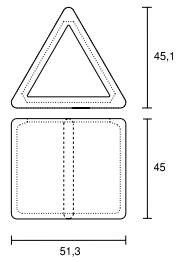

VIDA ref. 572

MESA . betão
 TABLE . concrete
 TABLE . béton . 170Kg.

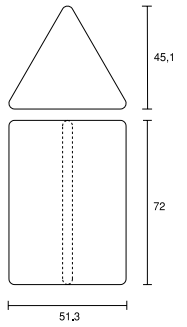

VIDA ref. 573

FLOREIRA . betão
 PLANTER . concrete
 BAC À FLEURS . béton . 170Kg.

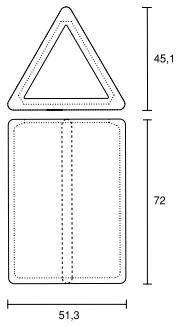

VIDA ref. 574

FLOREIRA . betão
 PLANTER . concrete
 BAC À FLEURS . béton . 225Kg.

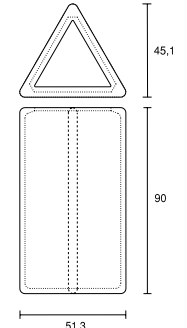

VIDA ref. 575

PAPELEIRA . betão + metal lacado
 LITTER BIN . concrete + lacquered metal
 CORBEILLE . béton + métal laquée . 125Kg.

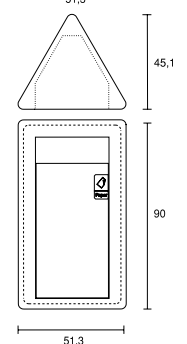



VIDA



VIDA ref. 576

DISSUASOR . betão
 BOLLARD . concrete
 BORNE DE DISSUASION . béton . 30Kg.

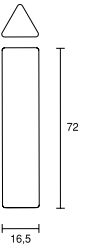

VIDA ref. 576.L

DISSUASOR COM ILUMINAÇÃO . betão
 BOLLARD WITH LIGHT . concrete
 BORNE DE DISSUASION AVEC ÉCLAIRAGE . béton . 30Kg.

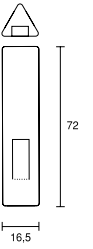

VIDA ref. 577

CINZEIRO . betão + metal lacado
 ASHTRAY . concrete + lacquered metal
 CENDRIER . béton + métal laquée . 210Kg.

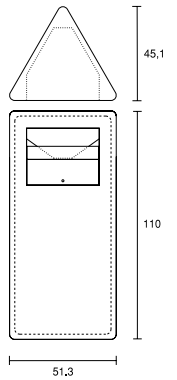

VIDA ref. 578

FLOREIRA WEDGE . betão
 WEDGE PLANTER . concrete
 BAC À FLEURS WEDGE . béton . 250Kg.

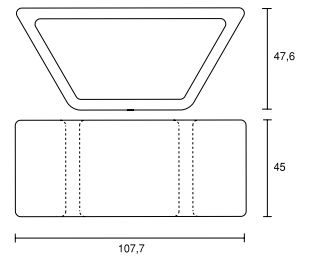

VIDA ref. 579

FLOREIRA HEXAGON . betão
 HEXAGON PLANTER . concrete
 BAC À FLEURS HEXAGON . béton . 350Kg.

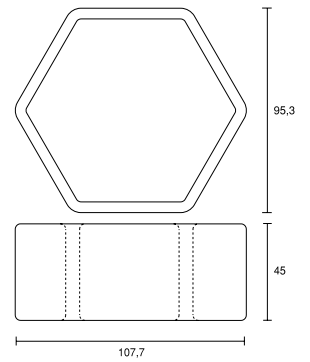

VIDA ref. 580

SINAL . betão
 SIGNAL . concrete
 SIGNAL . béton . 30Kg.

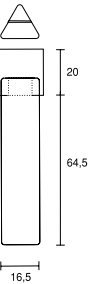

VIDA ref. 580.L

SINAL COM ILUMINAÇÃO . betão
 SIGNAL WITH LIGHT . concrete
 SIGNAL AVEC ÉCLAIRAGE . béton . 30Kg.

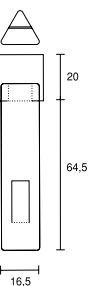



VIDA



BERG ref. 510.NX304

CADEIRA . betão reforçado com fibra + inox 304
 CHAIR . fibre reinforced concrete + 304 stainless steel
 CHAISE . béton renforcé avec de la fibre + inox 304 . 25Kg.

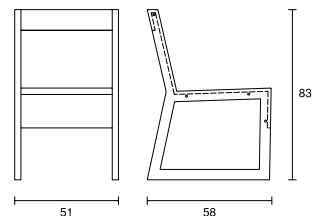

BERG ref. 511.NX304

BANCO INDIVIDUAL . betão reforçado com fibra + inox 304
 INDIVIDUAL BENCH . fibre reinforced concrete + 304 stainless steel
 BANC INDIVIDUEL . béton renforcé avec de la fibre + inox 304 . 25Kg.

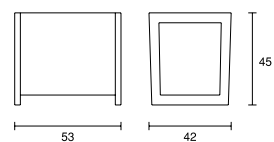

BERG ref. 513.NX304

FLOREIRA . betão reforçado com fibra + inox 304
 PLANTER . fibre reinforced concrete + 304 stainless steel
 BAC À FLEURS . béton renforcé avec de la fibre + inox 304 . 45Kg.

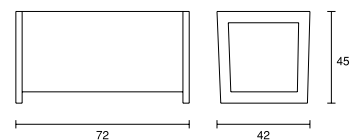

BERG ref. 514.NX304

PAPELEIRA . betão reforçado com fibra + inox 304
 LITTER BIN . fibre reinforced concrete + 304 stainless steel
 CORBEILLE . béton renforcé avec de la fibre + inox 304 . 45Kg.

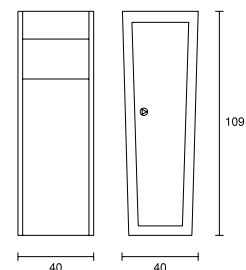

BERG ref. 512.NX304

MESA . betão reforçado com fibra + inox 304
 TABLE . fibre reinforced concrete + 304 stainless steel
 TABLE . béton renforcé avec de la fibre + inox 304 . 55Kg.

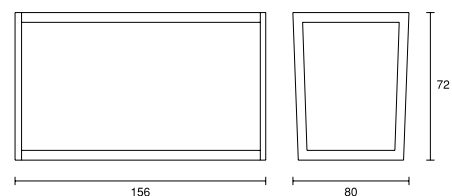

BERG ref. 515.NX304

DISSUASOR . betão reforçado com fibra + inox 304
 BOLLARD . fibre reinforced concrete + 304 stainless steel
 BORNE DE DISSUASION . béton renforcé avec de la fibre + inox 304 . 15Kg.

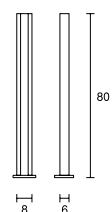

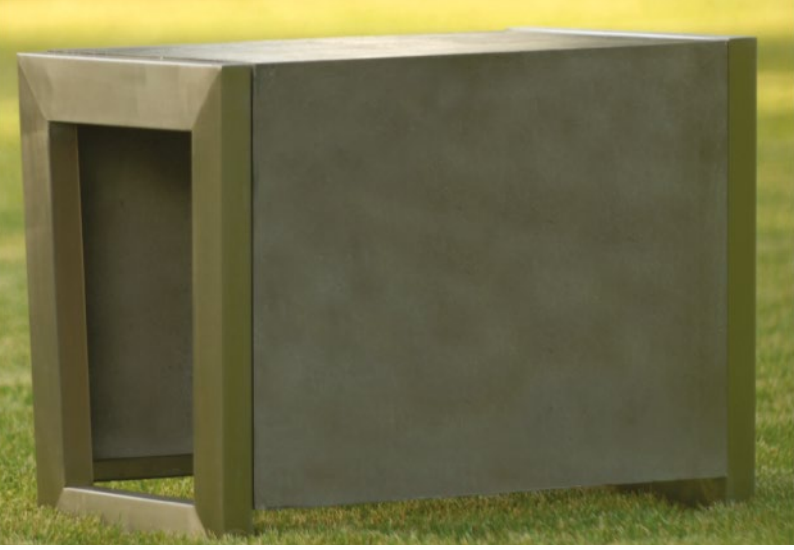

SIT
S
I
T



softshapes ref. 520

BANCO . betão reforçado com fibra
 BENCH . fibre reinforced concrete
 BANC . béton renforcé avec de la fibre . 170Kg.

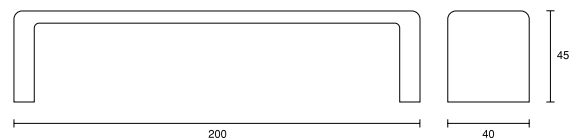

softshapes ref. 521

BANCO . betão reforçado com fibra
 BENCH . fibre reinforced concrete
 BANC . béton renforcé avec de la fibre . 85Kg.

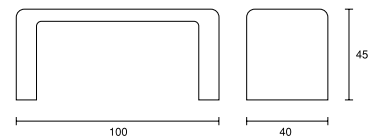

softshapes ref. 522

BANCO . betão reforçado com fibra
 BENCH . fibre reinforced concrete
 BANC . béton renforcé avec de la fibre . 60Kg.

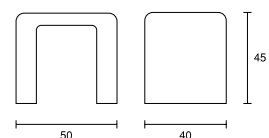

softshapes ref. 523

FLOREIRA . betão reforçado com fibra
 PLANTER . fibre reinforced concrete
 BAC À FLEURS . béton renforcé avec de la fibre . 70Kg.

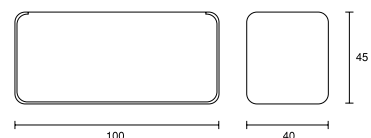

softshapes ref. 524.NX304

PAPELEIRA . betão reforçado com fibra + inox 304
 LITTER BIN . fibre reinforced concrete + 304 stainless
 CORBEILLE . béton renforcé avec de la fibre + inox 304 . 85Kg.

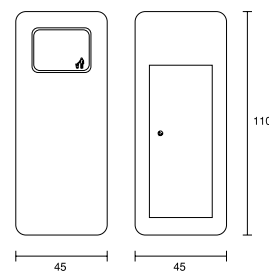

softshapes ref. 525

DISSUASOR . betão reforçado com fibra
 BOLLARD . fibre reinforced concrete
 BORNE DE DISSUASION . béton renforcé avec de la fibre . 30Kg.

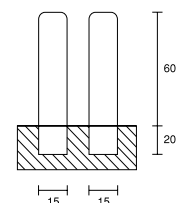

softshapes ref. 525.L

DISSUASOR COM ILUMINAÇÃO . betão reforçado com fibra
 BOLLARD WITH LIGHT . fibre reinforced concrete
 BORNE DE DISSUASION AVEC ÉCLAIRAGE . béton renforcé avec de la fibre . 30Kg.

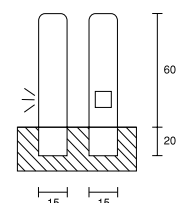



softshapes



STREET sofa ref. 550

SOFÁ INDIVIDUAL . betão reforçado com fibra
 INDIVIDUAL SOFA . fibre reinforced concrete
 CANAPÉ INDIVIDUEL . béton renforcé avec de la fibre . 145Kg.

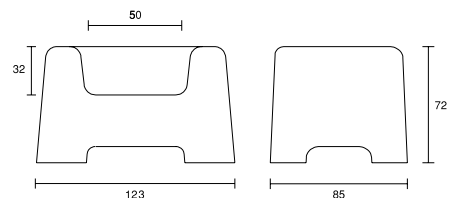

STREET sofa ref. 551

SOFÁ DUPLO . betão reforçado com fibra
 DOUBLE SOFA . fibre reinforced concrete
 CANAPÉ DOUBLE . béton renforcé avec de la fibre . 200Kg.

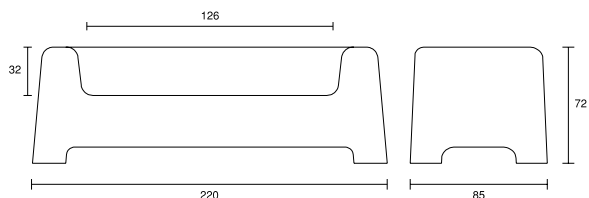

STREET sofa

WAVE ref. 104

BANCO . betão reforçado com fibra
 BENCH . fibre reinforced concrete
 BANC . béton renforcé avec de la fibre . 540Kg.

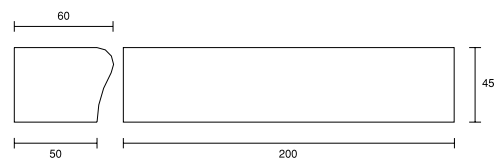

WAVE ref. 105

BANCO . betão reforçado com fibra
 BENCH . fibre reinforced concrete
 BANC . béton renforcé avec de la fibre . 350Kg.

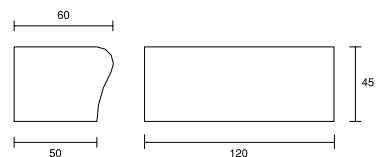

WAVE ref. 106

BANCO . betão reforçado com fibra
 BENCH . fibre reinforced concrete
 BANC . béton renforcé avec de la fibre . 300Kg.

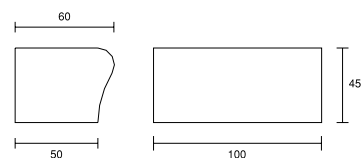

WAVE



STREET sofa



WAVE

LAY ref. 400

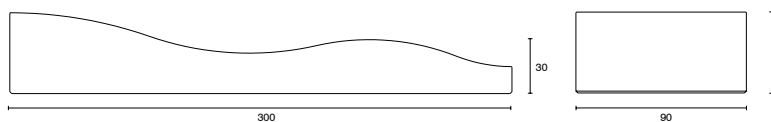

ESPREGUIÇADEIRA | BANCO . betão
SUN LOUNGER / BENCH . concrete
CHAISE LONGUE / BANC . béton . 1600Kg.

LAY ref. 401

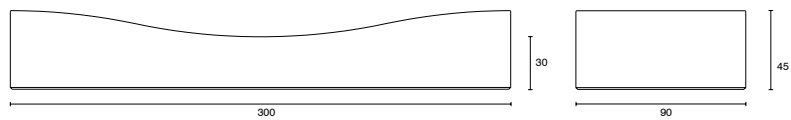

ESPREGUIÇADEIRA | BANCO . betão
SUN LOUNGER / BENCH . concrete
CHAISE LONGUE / BANC . béton . 1700Kg.



LAY



SUN ref. 800.C

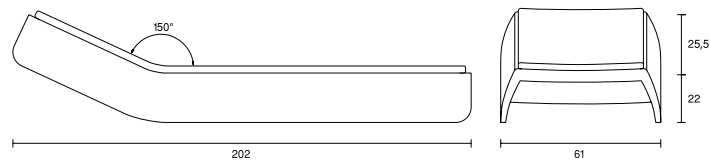

ESPREGUIÇADEIRA COM COLCHÃO . polietileno de alta densidade + colchão em carbon fibre ignifugo
 SUN LOUNGER WITH MATTRESS . high density polyethylene + carbon fibre mattress
 CHAISE LONGUE AVEC MATELAS . polyéthylène haute densité + matelas carbon fibre . 30Kg.

SUN ref. 800

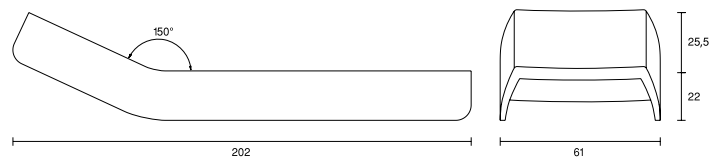

ESPREGUIÇADEIRA . polietileno de alta densidade
 SUN LOUNGER . high density polyethylene
 CHAISE LONGUE . polyéthylène haute densité . 30Kg.

SUN ref. 801

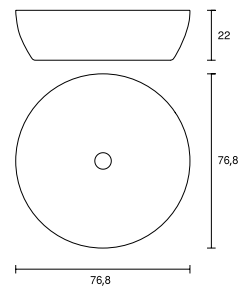

MESA . polietileno de alta densidade
 TABLE . high density polyethylene
 TABLE . polyéthylène haute densité . 10Kg.

SUN ref. 802

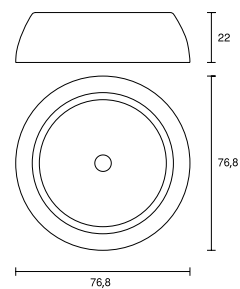

FLOREIRA . polietileno de alta densidade
 PLANTER . high density polyethylene
 BAC À FLEURS . polyéthylène haute densité . 10Kg.

SUN

PUFF ref. 810

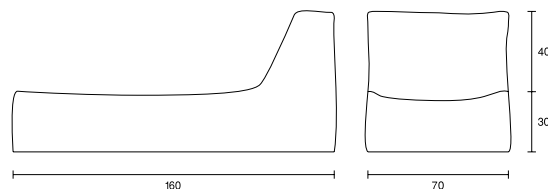

ESPREGUIÇADEIRA PUFF . fibra de carbono ignifugo
 SUN LOUNGER . carbon fibre
 CHAISE LONGUE . matelas carbon fibre. 15kg

PUFF



SUN

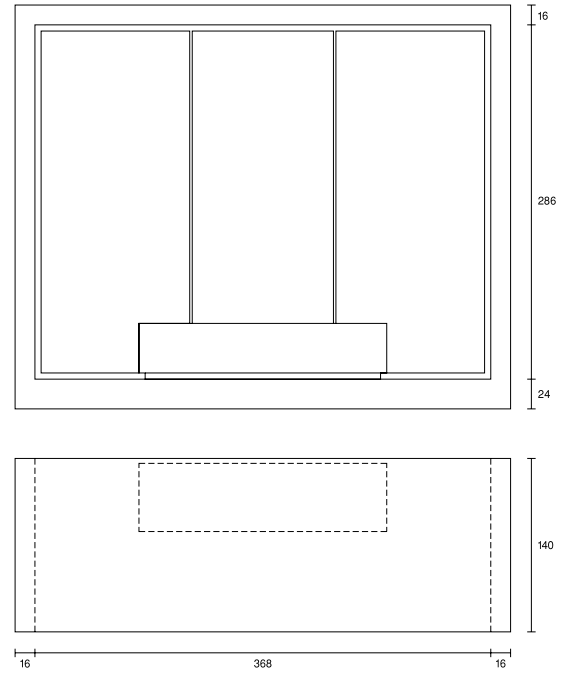

PUFF

BASIC ref. 390.B - BOX B

ABRIGO DE PASSAGEIROS + BANCO BOX . betão + vidro temperado
 BUS SHELTER + BOX BENCH. concrete + tempered glass
 ABRI POUR PASSAGERS + BANC BOX . béton + verre trempé . 7400Kg.

BASIC ref. 350 - B PARK

BOX
TO
BOX

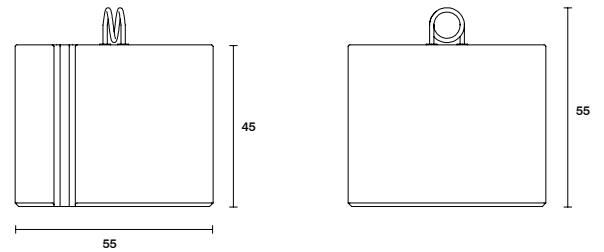

SUPORE DE BICICLETAS . betão + metal lacado
 BYCICLE RACK . concrete + lacquered metal
 FONTAINE . béton + métal laquée . 310Kg.

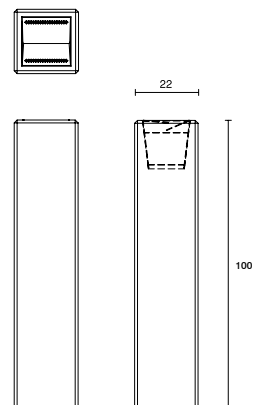
BASIC ref. 372 - CINZEIRO C

CINZEIRO . betão + metal lacado
 ASHTRAY. concrete + lacquered metal
 CENDRIER . béton + métal laquée . 110Kg.



BASIC



SIT



SIT

BASIC ref. 341.C - QC

PAPELEIRA+CINZEIRO . betão + metal lacado
 LITTER BIN+ASHTRAY. concrete + lacquered metal
 CORBEILLE+CENDRIER . béton + métal laquée . 165Kg.

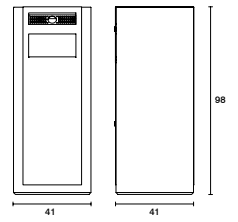
**BASIC** ref. 341 - Q

PAPELEIRA . betão + metal lacado
 LITTER BIN . concrete + lacquered metal
 CORBEILLE . béton + métal laquée . 165Kg.

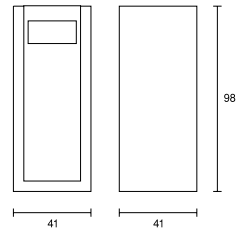
**BASIC** ref. 375 - BLOCK

PAPELEIRA . betão
 LITTER BIN . concrete
 CORBEILLE . béton . 250Kg.

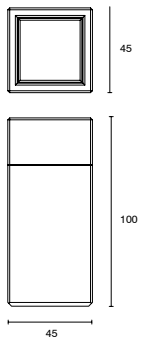
**BASIC** ref. 375.ECO - ECO-BLOCK

ECOPONTO . betão
 RECYCLING . concrete
 ECO POINT . béton . 750Kg.

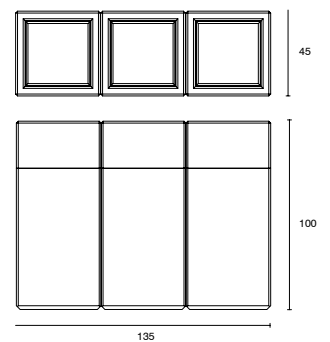



BASIC



BASIC ref. 342 - SPLIT

PAPELEIRA . ferro
LITTER BIN . iron
CORBEILLE . fer . 45Kg.

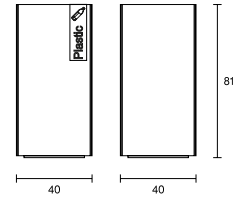

BASIC ref. 343 - SPLIT

PAPELEIRA . ferro
LITTER BIN . iron
CORBEILLE . fer . 35Kg.

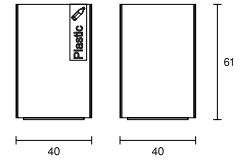

BASIC ref. 340.C - CY

PAPELEIRA . ferro
LITTER BIN . iron
CORBEILLE . fer . 27Kg.

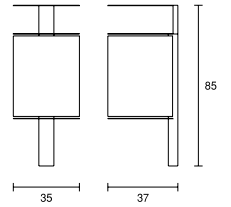

BASIC ref. 340 - CY

PAPELEIRA . ferro
LITTER BIN . iron
CORBEILLE . fer . 24Kg.

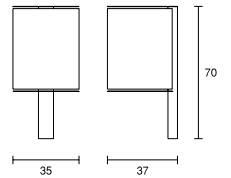

BASIC ref. 380 - FIT

CALDEIRA . ferro
TREE SURROUNDS . iron
GRILLE D'ARBRE . fer . 122Kg.

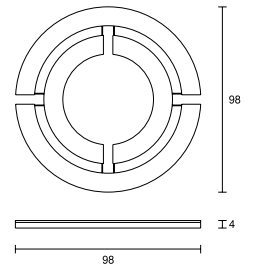

BASIC ref. 381 - ROUND

CALDEIRA . ferro
TREE SURROUNDS . iron
GRILLE D'ARBRE . fer . 124Kg.

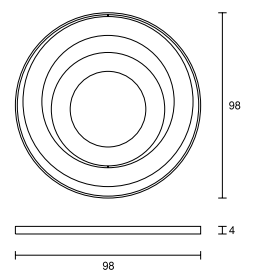



BASIC



BASIC ref. 371 - FONTANÁRIO

FONTANÁRIO . betão + inox 304
FOUNTAIN . concrete + 304 stainless steel
FONTAINE . béton + inox 304 . 250Kg.

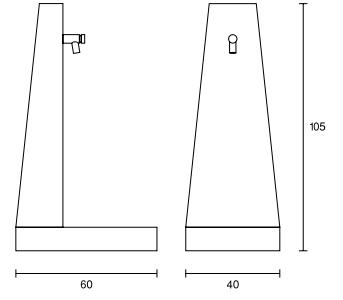

BASIC ref. 370 - COLUNA

BEBEDOURO . betão
DRINKING FOUNTAIN . concrete
ABREUVOIR . béton . 120Kg.

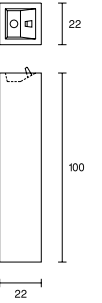

BASIC ref. 373 - COLUNA R

BEBEDOURO . betão
DRINKING FOUNTAIN . concrete
ABREUVOIR . béton . 110Kg.

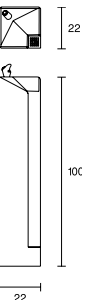



BASIC



BASIC ref. 100 - OMEGA

BANCO . betão
 BENCH . concrete
 BANC . béton . 460Kg.

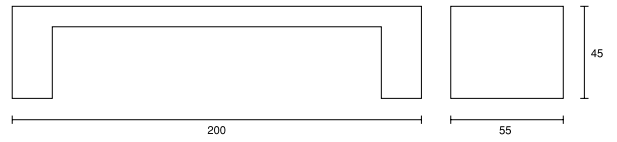

BASIC ref. 101 - TT

BANCO . betão
 BENCH . concrete
 BANC . béton . 460Kg.

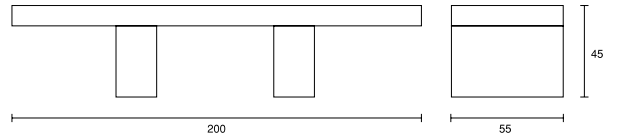

BASIC ref. 111 - BOX

BANCO . betão
 BENCH . concrete
 BANC . béton . 1100Kg.

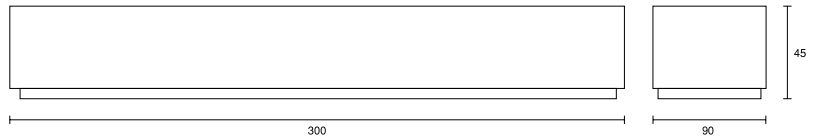

BASIC ref. 102 - BOX

BOX
 TO
 BOX

BANCO . betão
 BENCH . concrete
 BANC . béton . 590Kg.

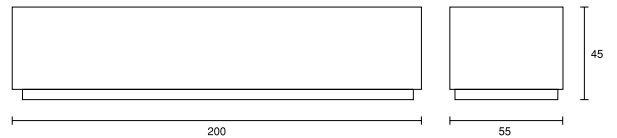

BASIC ref. 112 - BOX

BOX
 TO
 BOX

BANCO . betão
 BENCH . concrete
 BANC . béton . 330Kg.

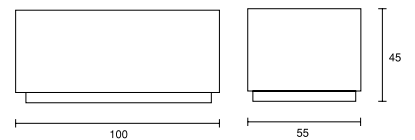

BASIC ref. 109 - CUBO

BANCO INDIVIDUAL . betão
 INDIVIDUAL BENCH . concrete
 BANC INDIVIDUEL . béton . 240Kg.

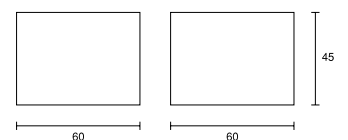



BASIC



**BOX
TO
BOX**



BASIC ref. 102.WB - BOX WB

BOX
TO
BOX

BANCO . betão + madeira
BENCH . fibre + wood
BANC . béton + bois . 620Kg

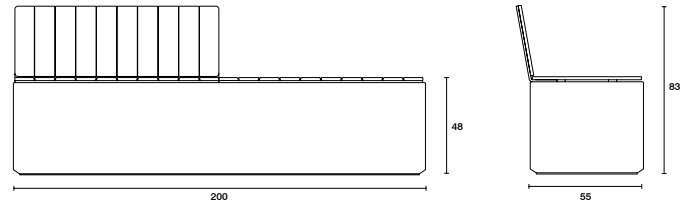

BASIC ref. 102.WBH - BOX WBH

BOX
TO
BOX

BANCO . betão + madeira
BENCH . fibre + wood
BANC . béton + bois . 610Kg

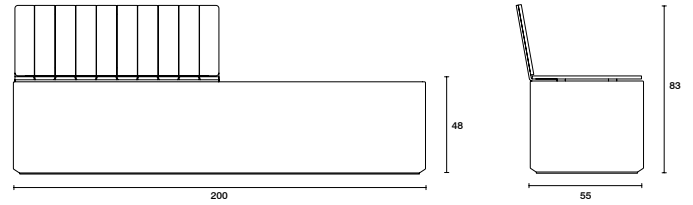

BASIC ref. 102.W - BOX W

BOX
TO
BOX

BANCO . betão + madeira
BENCH . fibre + wood
BANC . béton + bois . 610Kg

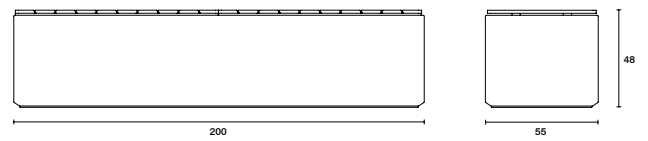

BASIC ref. 102.WH - BOX WH

BOX
TO
BOX

BANCO . betão + madeira
BENCH . fibre + wood
BANC . béton + bois . 600Kg

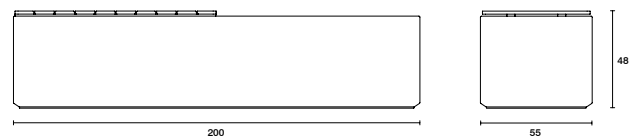

BASIC

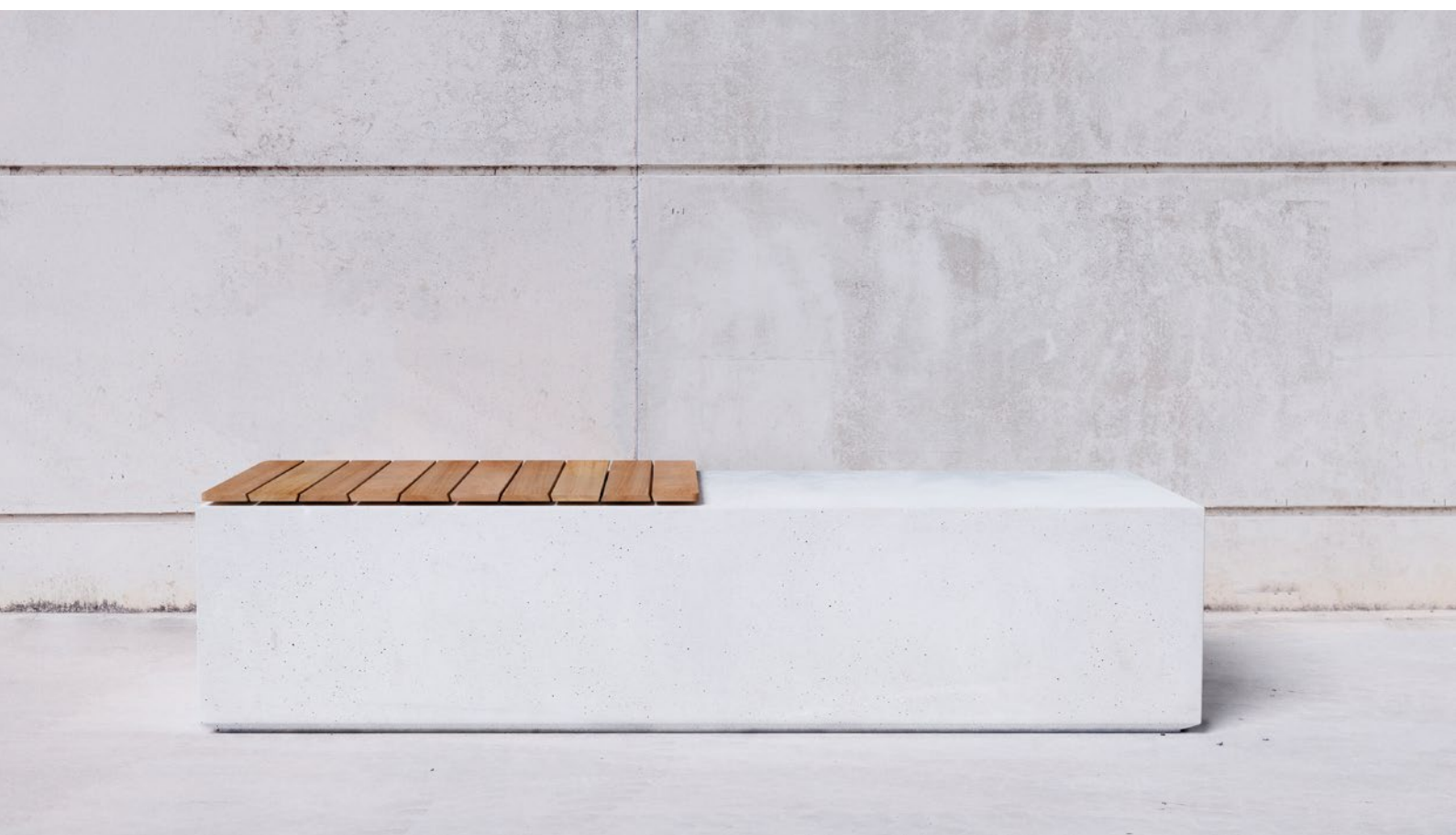
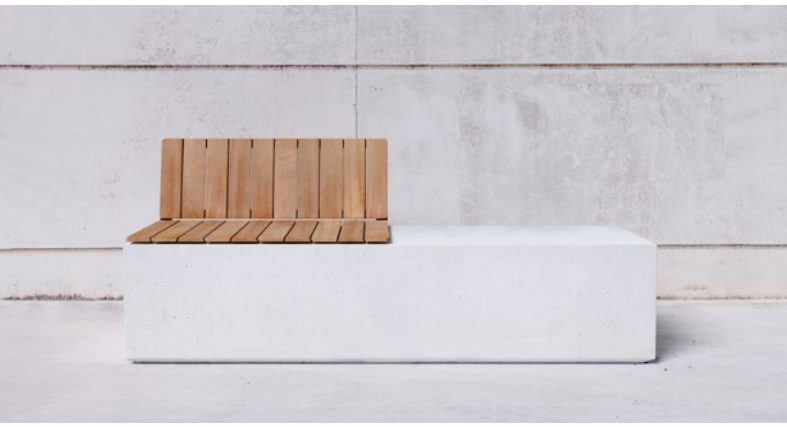

BASIC ref. 103 - ROUND B

BOX
TO
BOX

BANCO . betão
BENCH . concrete
BANC . béton . 750Kg

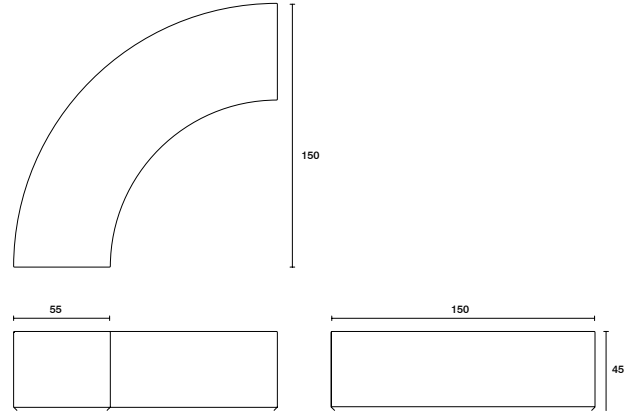

BASIC ref. 108 - CUBO B

BOX
TO
BOX

BANCO . betão
BENCH . concrete
BANC . béton . 220Kg

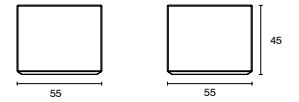

BASIC ref. 116 -BOX Y

BOX
TO
BOX

BANCO . betão
BENCH . concrete
BANC . béton . 600Kg

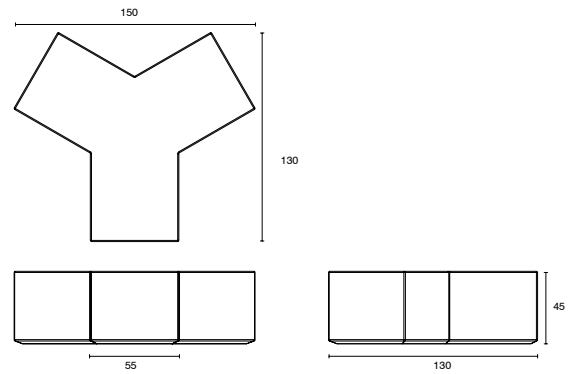

BASIC ref. 115 - CUBO 90

BANCO . betão
BENCH . concrete
BANC . béton . 450Kg

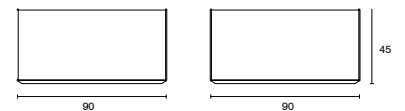



BASIC

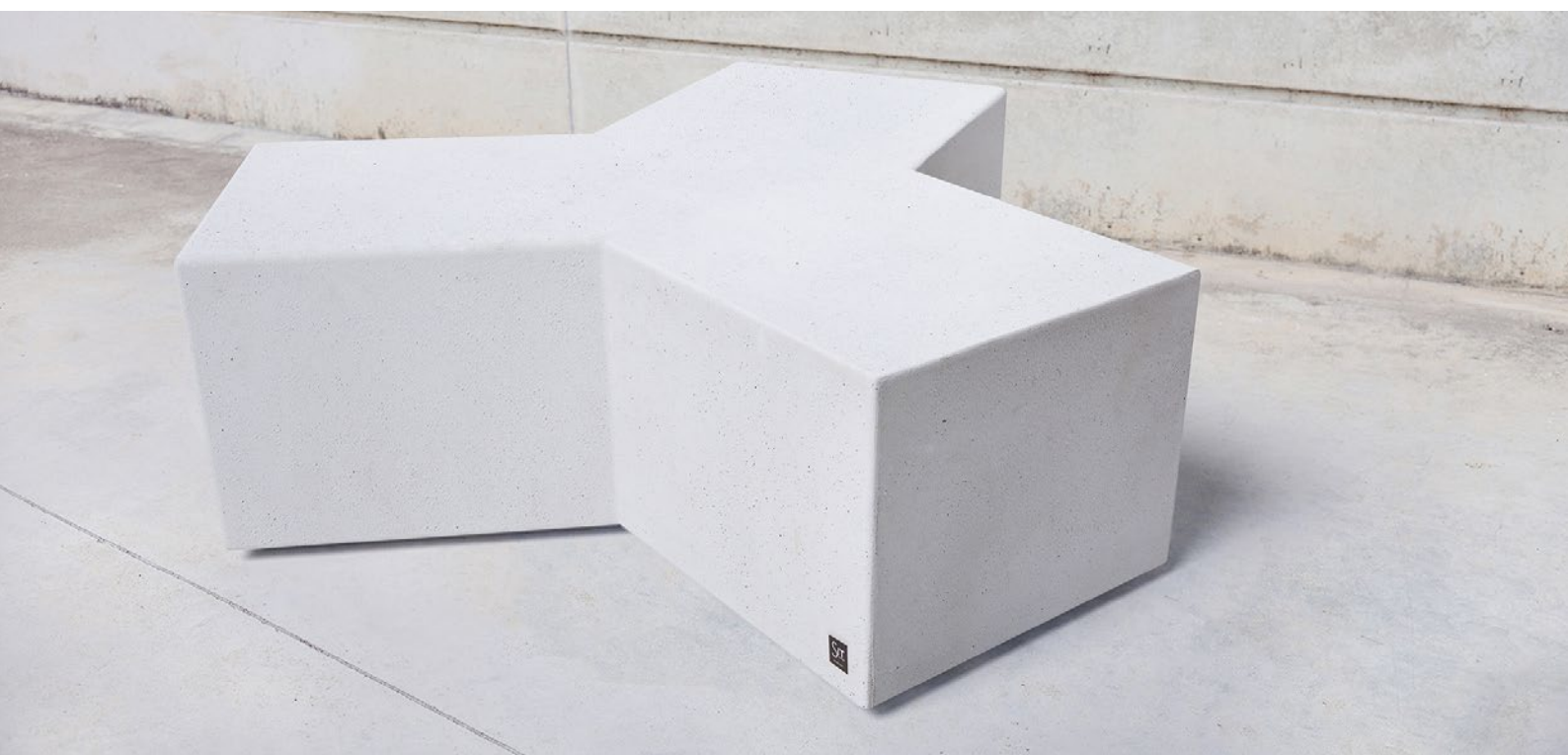

BASIC ref. 102.VL - BOX V - L

**BOX
TO
BOX**

BANCO . betão
BENCH . concrete
BANC . béton . 490Kg

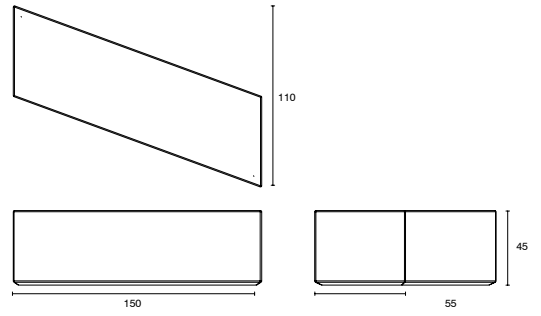

BASIC ref. 102.VR - BOX V - R

**BOX
TO
BOX**

BANCO . betão
BENCH . concrete
BANC . béton . 490Kg

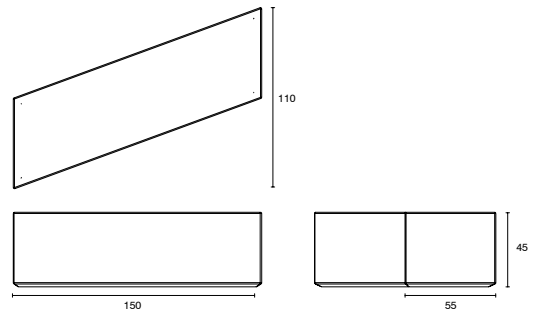

BASIC ref. 205.VL - BOX V - L

**BOX
TO
BOX**

FLOREIRA . betão
PLANTER . concrete
BAC À FLEURS . béton . 410Kg

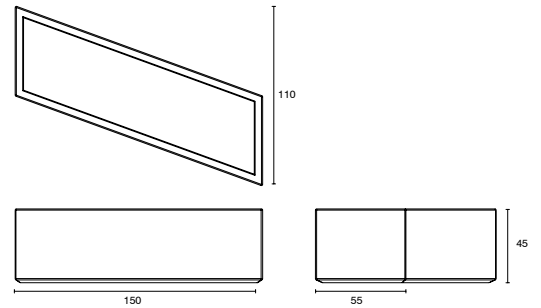

BASIC ref. 205.VR - BOX V - R

**BOX
TO
BOX**

FLOREIRA . betão
PLANTER . concrete
BAC À FLEURS . béton . 410Kg

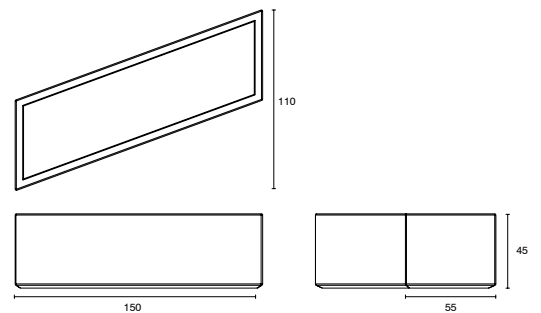



BASIC



BASIC ref. 201.B - BIG BOX B

**BOX
TO
BOX**

FLOREIRA . betão
PLANTER . concrete
BAC À FLEURS . béton . 490Kg

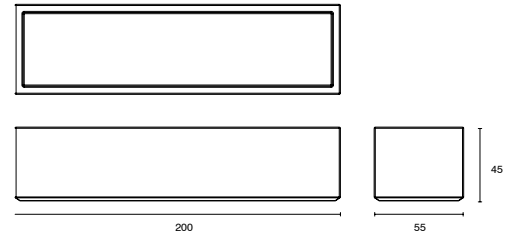

BASIC ref. 205.B - BOX B

**BOX
TO
BOX**

FLOREIRA . betão
PLANTER . concrete
BAC À FLEURS . béton . 300Kg

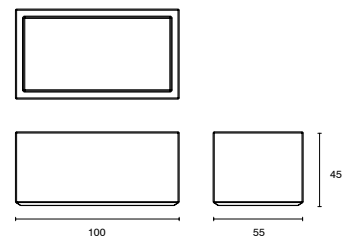

BASIC ref. 212.B - CUBIC B

**BOX
TO
BOX**

FLOREIRA . betão
PLANTER . concrete
BAC À FLEURS . béton . 190Kg

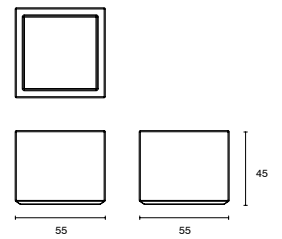

BASIC ref. 361 - LINE

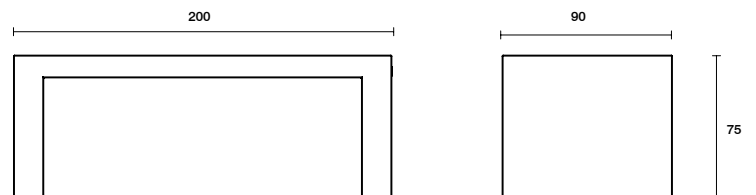

MESA . betão
TABLE . concrete
TABLEA . béton . 990Kg



BASIC



BASIC ref. 330 - FEST

VEDAÇÃO . betão + pvc
 FENCE . concrete + pvc
 CLÔTURE . béton + pvc . 300Kg.

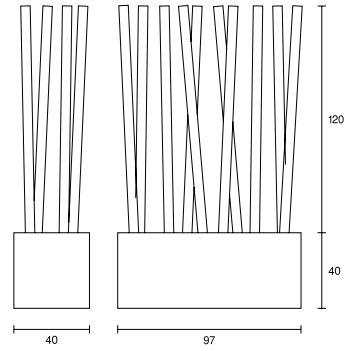
**BASIC** ref. 205.MCFM - FENCE M

FLOREIRA COM DIVISÓRIA . betão + metal
 PLANTER WITH DIVIDER . concrete + metal
 JARDINIÈRE AVEC DIVISEUR . béton + fer . 330Kg

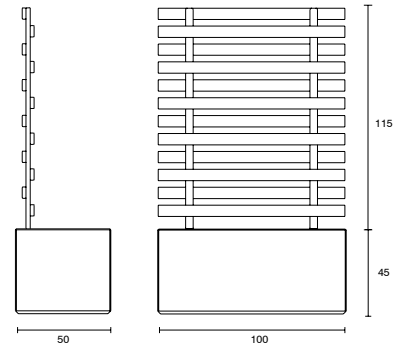
**BASIC** ref. 205.MCFM - FENCE W

FLOREIRA COM DIVISÓRIA . betão + aço inoxidável + madeira
 PLANTER WITH DIVIDER . concrete + stainless steel + wood
 JARDINIÈRE AVEC DIVISEUR . béton + acier inoxydable + bois . 320Kg

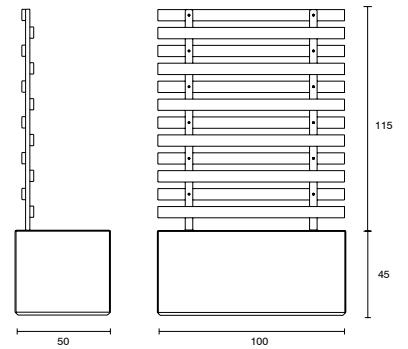



BASIC



BASIC ref. 233 - SLIM

FLOREIRA . betão
PLANTER . concrete
BAC À FLEURS . béton . 150Kg

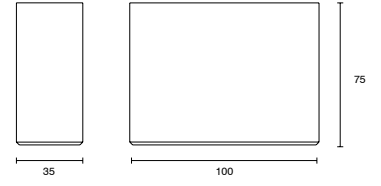

BASIC ref. 230 - VASO S

FLOREIRA . betão
PLANTER . concrete
BAC À FLEURS . béton . 75Kg

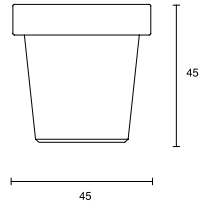

BASIC ref. 231 - VASO M

FLOREIRA . betão
PLANTER . concrete
BAC À FLEURS . béton . 210Kg

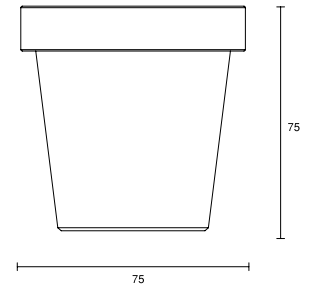

BASIC ref. 232 - VASO L

FLOREIRA . betão
PLANTER . concrete
BAC À FLEURS . béton . 570Kg

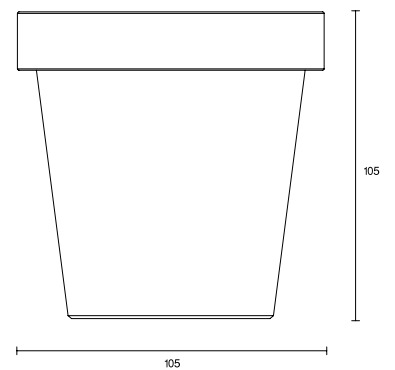



BASIC



BASIC ref. 201 - BIG BOX

FLOREIRA . betão reforçado com fibra

PLANTER . fibre reinforced concrete

BAC À FLEURS . béton renforcé avec de la fibre . 195Kg.

BASIC ref. 201.MC - BIG BOX

FLOREIRA . betão

PLANTER . concrete

BAC À FLEURS . béton . 510Kg.

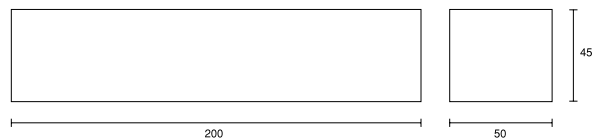
**BASIC** ref. 203 - BIG BOX

FLOREIRA . betão reforçado com fibra

PLANTER . fibre reinforced concrete

BAC À FLEURS . béton renforcé avec de la fibre . 115Kg.

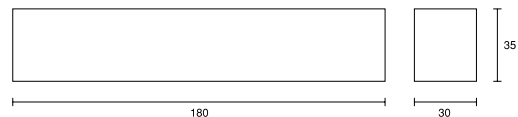
**BASIC** ref. 205 - BOX

FLOREIRA . betão reforçado com fibra

PLANTER . fibre reinforced concrete

BAC À FLEURS . béton renforcé avec de la fibre . 105Kg.

BASIC ref. 205.MC - BOX

FLOREIRA . betão

PLANTER . concrete

BAC À FLEURS . béton . 295Kg.

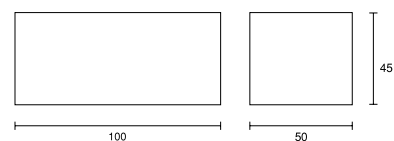
**BASIC** ref. 207 - BOX

FLOREIRA . betão reforçado com fibra

PLANTER . fibre reinforced concrete

BAC À FLEURS . béton renforcé avec de la fibre . 55Kg.

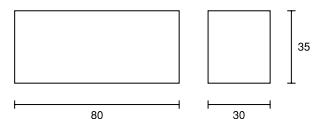
**BASIC** ref. 213 - IOTA

FLOREIRA . betão reforçado com fibra

PLANTER . fibre reinforced concrete

BAC À FLEURS . béton renforcé avec de la fibre . 155Kg.

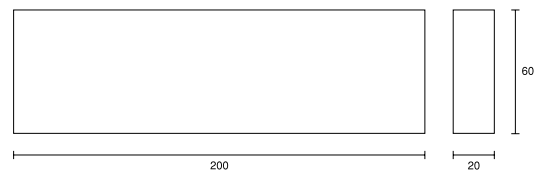
**BASIC** ref. 214 - IOTA

FLOREIRA . betão reforçado com fibra

PLANTER . fibre reinforced concrete

BAC À FLEURS . béton renforcé avec de la fibre . 80Kg.

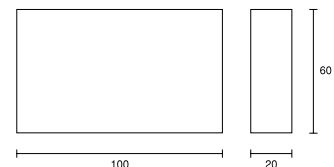
**BASIC** ref. 218 - IOTA

FLOREIRA . betão reforçado com fibra

PLANTER . fibre reinforced concrete

BAC À FLEURS . béton renforcé avec de la fibre . 45Kg.

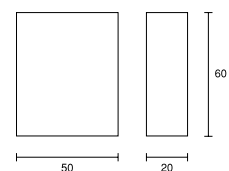



BASIC



BASIC ref. 221.MC - CUBIK

FLOREIRA . betão
 PLANTER . concrete
 BAC À FLEURS . béton . 970Kg.

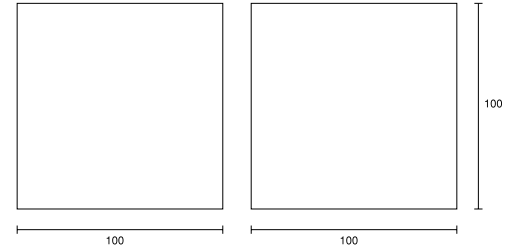
**BASIC** ref. 209 - CUBIK

FLOREIRA . betão reforçado com fibra
 PLANTER . fibre reinforced concrete
 BAC À FLEURS . béton renforcé avec de la fibre . 220Kg.

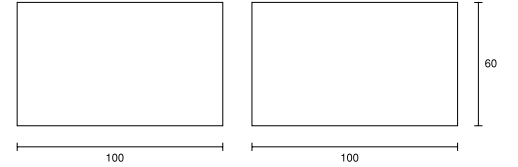
**BASIC** ref. 209.MC - CUBIK

FLOREIRA . betão
 PLANTER . concrete
 BAC À FLEURS . béton . 530Kg.

BASIC ref. 211 - CUBIK

FLOREIRA . betão reforçado com fibra
 PLANTER . fibre reinforced concrete
 BAC À FLEURS . béton renforcé avec de la fibre . 60Kg.

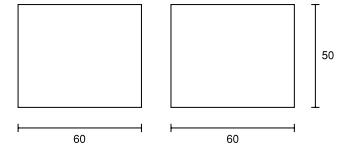
**BASIC** ref. 211.MC - CUBIK

FLOREIRA . betão
 PLANTER . concrete
 BAC À FLEURS . béton . 215Kg.

BASIC ref. 212 - CUBIK

FLOREIRA . betão reforçado com fibra
 PLANTER . fibre reinforced concrete
 BAC À FLEURS . béton renforcé avec de la fibre . 50Kg.

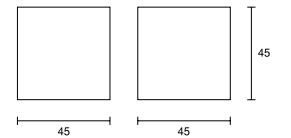
**BASIC** ref. 351.RDF

DISSUASOR . ferro
 BOLLARD . iron
 BORNE DE DISSUASION . fer . 5Kg.

BASIC ref. 351.RDNX304

DISSUASOR . inox 304
 BOLLARD . 304 stainless steel
 BORNE DE DISSUASION . inox 304 . 5Kg.

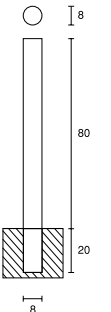
**BASIC** ref. 352.QDF

DISSUASOR . ferro
 BOLLARD . iron
 BORNE DE DISSUASION . fer . 5Kg.

BASIC ref. 352.QDNX304

DISSUASOR . inox 304
 BOLLARD . 304 stainless steel
 BORNE DE DISSUASION . inox 304 . 5Kg.

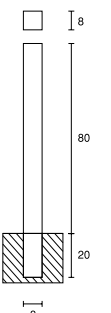



BASIC ref. 217 - SQUARE

FLOREIRA . betão reforçado com fibra
PLANTER . fibre reinforced concrete
BAC À FLEURS . béton renforcé avec de la fibre . 295Kg.

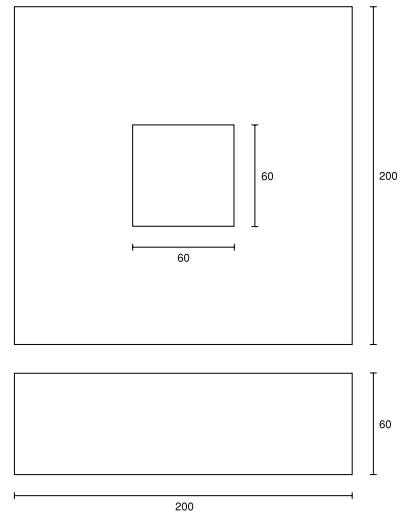

BASIC ref. 216 - SQUARE

FLOREIRA . betão reforçado com fibra
PLANTER . fibre reinforced concrete
BAC À FLEURS . béton renforcé avec de la fibre . 155Kg.

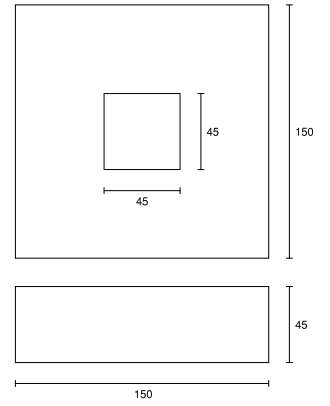

BASIC ref. 215 - SQUARE

FLOREIRA . betão reforçado com fibra
PLANTER . fibre reinforced concrete
BAC À FLEURS . béton renforcé avec de la fibre . 75Kg.

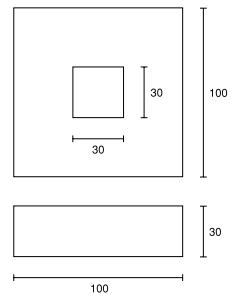



BASIC ref. 222 - STILL

FLOREIRA . ferro
 PLANTER . iron
 BAC À FLEURS . fer . 45Kg.

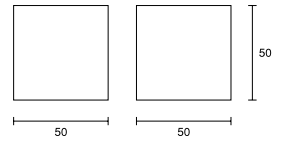
**BASIC** ref. 223 - STILL

FLOREIRA . ferro
 PLANTER . iron
 BAC À FLEURS . fer . 70Kg.

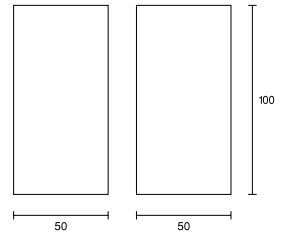
**BASIC** ref. 224 - STILL

FLOREIRA . ferro
 PLANTER . iron
 BAC À FLEURS . fer . 65Kg.

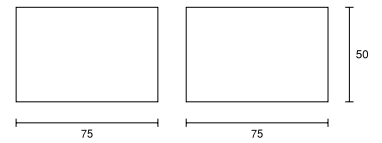
**BASIC** ref. 225 - STILL

FLOREIRA . ferro
 PLANTER . iron
 BAC À FLEURS . fer . 110Kg.

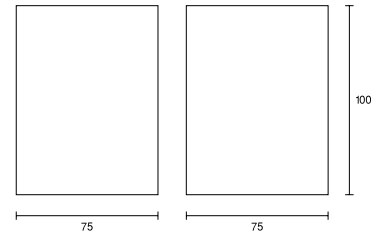
**BASIC** ref. 226 - STILL

FLOREIRA . ferro
 PLANTER . iron
 BAC À FLEURS . fer . 60Kg.

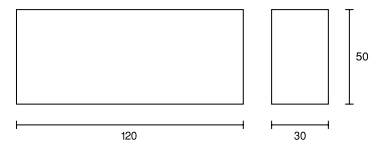
**BASIC** ref. 227 - STILL

FLOREIRA . ferro
 PLANTER . iron
 BAC À FLEURS . fer . 80Kg.

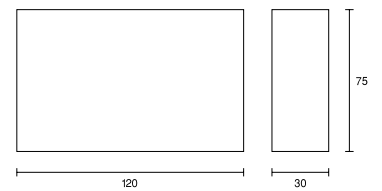
**BASIC** ref. 228 - STILL

FLOREIRA . ferro
 PLANTER . iron
 BAC À FLEURS . fer . 45Kg.

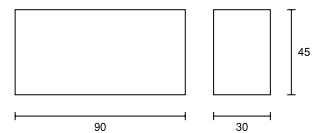
**BASIC** ref. 229 - STILL

FLOREIRA . ferro
 PLANTER . iron
 BAC À FLEURS . fer . 85Kg.

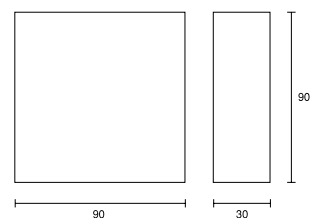



BASIC





SIT URBAN DESIGN

Av. Nossa Sra. da Vitória, 8 . S. Jorge

2480-062 Porto de Mós . Portugal

tel. +351 244 482 525 . fax +351 244 481 385

www.aboutsit.com . info@aboutsit.com

GPS: 39°37'50.71"N . 8°51'10.44"W
