



MACCHINE AGRICOLE

BADALINI



FOR YOUR SOILS AND YOUR HEALTH

MULTIFRESE MULTI-ROW ROTOTILLERES

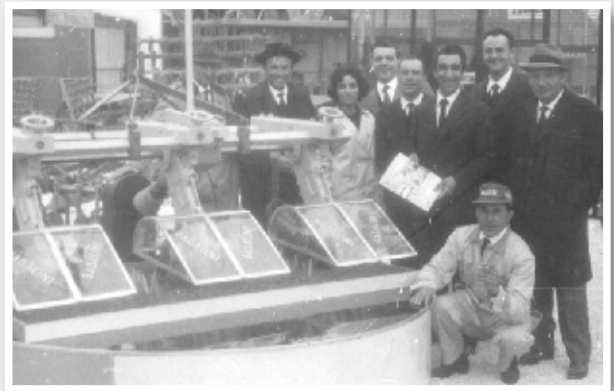





CERES MULTIFRESA

La vasta gamma di accessori per completare questo modello come spandiconcime, guida, rincalzatori, telaio pieghevole per il trasporto stradale, rendono possibile l'allestimento personalizzato per ogni cliente.

In pratica produciamo la macchina su misura e specifica del cliente. Non è più l'utilizzatore che acquista la macchina che trova in commercio, ma è la ditta costruttrice che plasma la macchina a misura dell'acquirente.



The vast range of accessories to complete this model as fertilizer distributor, ridging units, steering unit, kit for closing for the road transport, allow to manufacture the personalized equipment to every customer. In practice we manufacture the machine according to the specifics of our customer.

So the farmer has not to purchases the machine he finds in commerce, but it is the manufacturing firm that moulds the equipment to his measure.



CERES



DOTAZIONE DI SERIE / STANDARD EQUIPMENT:

- Normativa CE / CE Regulations equipments
- Carter oscillanti / Oscillant protections
- Catene ASA 60-H / Chain ASA 60-H
- Telaio in fusione di acciaio / Frame in cast steel
- Zappe e bulloni alta resistenza / High resistant blades and bolts
- Albero cardanico con vite di sicurezza / Cardan shaft with safety bolt
- Albero trasmissione quadrato 30 mm / Square transmission shaft 30 mm
- Coppia ruote con cuscinetti D=360 mm / Couple wheels with bearings D=360 mm
- Scatola catena in fusione con finestra laterale per ispezione / Chain box in cast steel with side window for inspection

SEZIONE TELAIO FRAME SECTION

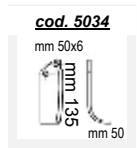
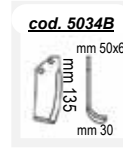
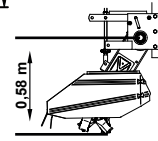

CV / HP	MODELLO / MODEL	N. CORPI / UNITS NR.	N. FILARI / ROWS NR.	TELAIO metri / FRAME meters	PESO / WEIGHT Kg
MOD. "STANDARD" (SS) PER FILARI DA mm 300-350 LAVORO mm 185-220 (COFANO) / FOR ROWS OF mm 300-350 WORK mm 185-220 (BONNET)					
40-45	MCn/2SS	2	1	1,60	330
40-50	MCn/3SS	2	2	1,80	380
45-50	MCn/4SS	4	3	2,00	430
45-50	MCn/5SS	5	4	2,40	490
50-60	MCn/6SS	6	5	2,40	580
50-60	MCn/7SS	7	6	3,00	640
MOD. "STANDARD" (ST) PER FILARI DA mm 450-500 LAVORO mm 290-340 (COFANO) / FOR ROWS OF mm 450-500 WORK mm 290-340 (BONNET)					
40-45	MCn/4ST	4	4	2,00	450
40-50	MCn/5ST (3+2)	5	4	2,40	530
45-50	MCn/6ST (4+2)	6	5	3,30	600
45-50	MCnR/6ST (4+2)	6	5	3,30/2,50	640
50-60	MCn/7ST (5+2)	7	6	3,30	670
50-60	MCnR/7ST (5+2)	7	6	3,30/2,50	700
MOD. "MEDIO LARGO" (ML) PER FILARI DA mm 600-650-700 LAVORO mm 390-440-490 (COFANO) / FOR ROWS OF mm 600-650-700 WORK mm 390-440-490 (BONNET)					
40-45	MCn/3 ML	3	-	2,00	330
50-60	MCn/5ML (3+2)	5	4	3,30	550
50-60	MCnR/5ML (3+2)	5	4	3,30/2,50	620
MOD. "LARGO" (L) PER FILARI DA mm 700-750-800 LAVORO mm 540-590-650 (COFANO) / FOR ROWS OF mm 700-750-800 WORK mm 540-590-650 (BONNET)					
30-45	MCn/2L	2	-	2,00	360
45-55	MCn/3L	3	-	2,40	460
50-60	MCn/5L (3+2)	5	4	3,30	580
50-60	MCn/5L (3+2)	5	4	3,30/2,50	610

MCn/ = telaio fisso / fixed frame

MCnR/ = telaio pieghevole manuale / mechanical folding frame

MCnI/ = telaio pieghevole idraulico / hydraulic folding frame

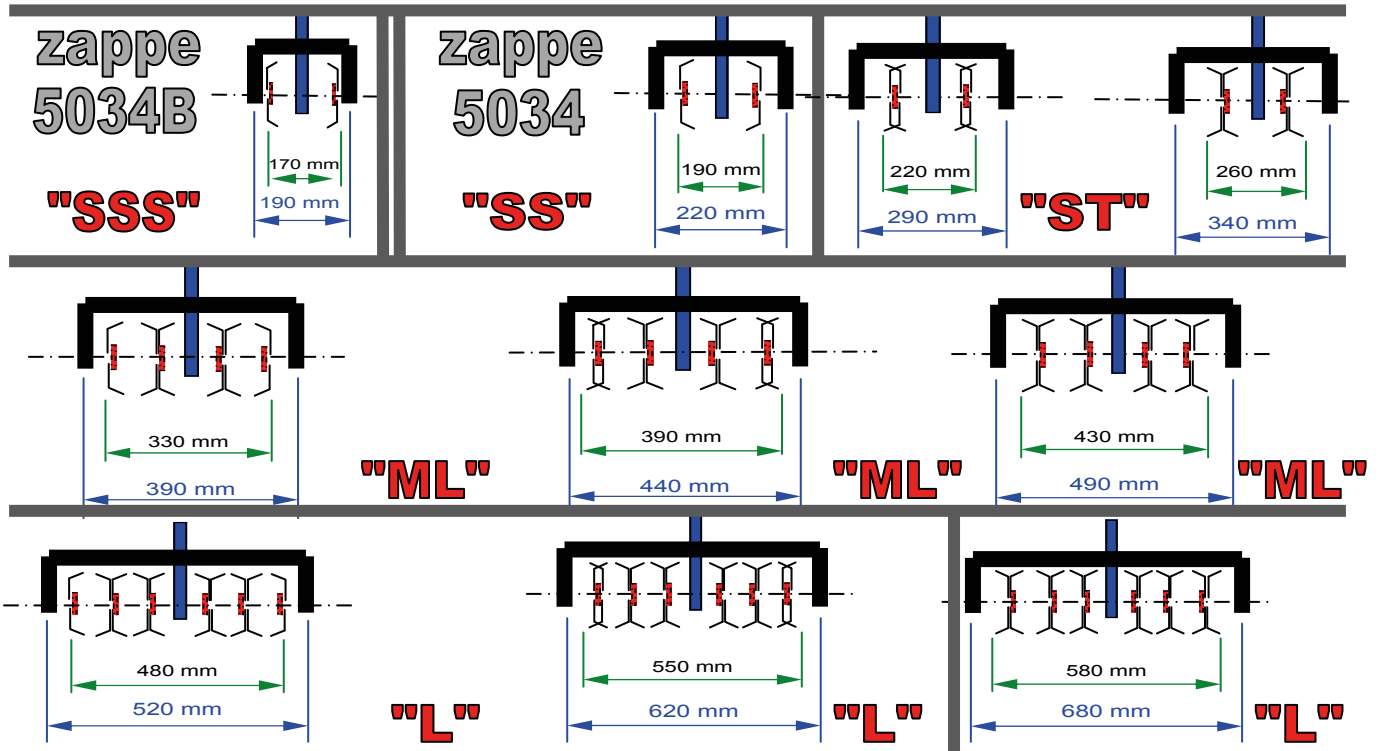





ERMES MULTIFRESA

MEn/

Caratteristiche / Features

Telaio in fusione di acciaio / *Frame in structural tubular*

Catena asa **80 H** rinforzata / *Asa 80 H strenghtened chain*

Altezza sotto l'albero mm 630 / *Clearance under the shaft mm 630*

Albero di trasmissione esagonale 41 mm / *Hexagonal transmission on shaft 41 mm*

Carter oscillanti / *Oscillant protections*

Zappe e bulloni ad alta resistenza / *High resistant hoes and bolts*

Scatola catena in fusione con finestra laterale per ispezione coppia ruote con cuscinetti su telaio / *Chain box in steel with side window for inspection couple of wheels with bearings on frame*

Albero cardanico con vite di sicurezza / *Cardan shaft with safety bolt*

Optional a richiesta

Protezioni albero rotante / *rotating shaft protections*

Ancora a molla anteriore / *Front tine*

Guida manuale o idraulica / *Manual or hydraulic steering unit*

Corpi rinalzatori / *Ridging units*

Spandiconcime con diverse capacità / *Fertilizer spreader with different capacity*

Sistema di chiusura per il trasporto su strada / *Closing system of the frame for the transport on road*



Le sue caratteristiche rendono la multifresa modello MEn/ particolarmente adatta al lavoro su colture con filari da 450 a 700 mm.

La tradizionale. Il modello MEn/ è l'erede della prima multifresa al mondo. Si adatta un po' a tutte le coltivazioni, dal finocchio alla barbabietola. Nonostante non sia troppo massiccia, garantisce un'eccezionale robustezza. Si conoscono macchine di questo tipo che lavorano da 30 anni senza aver dato il minimo problema.

*Its characteristics make the multi-row rototiller model Ermes MEn/ particularly proper for work on crops with rows from 45 to 70 cm. **The traditional one.** The model MEn/ is the heir of the first multi-row rototiller in the world. It adapts itself to all the cultivations, from fennel to beet. Despite it is not too much thick, it guarantees a great sturdiness. Machines of this type are known to have been working for 30 years, without having the minumum problem.*

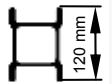

DOTAZIONE DI SERIE / STANDARD EQUIPMENT:

Normativa CE / CE Regulations equipments

Carter oscillanti / Oscillant protections

Catene ASA 80-H / Chain ASA 80-H

Telaio in fusione di acciaio / Frame in cast steel

Zappe e bulloni alta resistenza / High resistant blades and bolts

Albero cardanico con vite di sicurezza / Cardan shaft with safety bolt

Albero trasmissione esagonale 41 mm / Hexagonal transmission shaft 41 mm

Coppia ruote con cuscinetti D=360 mm / Couple wheels with bearings D=360 mm

Scatola catena in fusione con finestra laterale per ispezione / Chain box in cast steel with side window for inspection

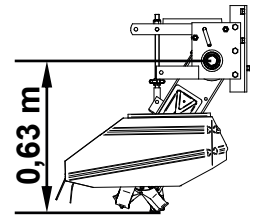

cod. 5145B

mm 50x8



mm 50

MOD. "STANDARD" (ST) PER FILARI DA mm 450-500 LAVORO mm 290-340 (COFANO) / FOR ROWS OF mm 450-500 WORK mm 290-340 (BONNET)

CV / HP	MODELLO / MODEL	N. CORPI / UNITS NR.	N. FILARI / ROWS NR.	TELAIO metri / FRAME meters	PESO Kg / WEIGHT Kg
35-45	MEn/4ST	4	4	2,20	790
40-55	MEn/5ST (3+2)	5	4	2,40	930
50-70	MEn/6ST (4+2)	6	5	3,00	1050
50-70	MEnR/6ST (4+2)	6	5	3,20/2,50	1100
60-80	MEn/7ST (5+2)	7	6	3,20	1000
60-80	MEnR/7ST (5+2)	7	6	3,20/2,50	1050

MOD. "MEDIO LARGO" (ML) PER FILARI DA mm 600-650-700 LAVORO mm 390-440-490 (COFANO) / FOR ROWS mm 600-650-700 WORK mm 410-460-510 (BONNET)

30-40	MEn/2ML	2	3	2,00	470
30-40	MEn/3ML	3	-	2,00	670
50-70	MEn/5ML (3+2)	5	4	3,00	970
50-70	MEnR/5ML (3+2)	5	4	3,20/2,50	1030

MOD. "LARGO" (L) PER FILARI DA mm 700-750-800 LAVORO mm 510-570-620 (COFANO) / FOR ROWS OF mm 700-750-800 WORK mm 510-560-610 (BONNET)

30-45	MEn/2L	2	-	2,20	480
40-60	MEn/3L	3	-	2,20	680
60-80	MEn/5L (3+2)	5	4	3,20	980
60-80	MEn/5L (3+2)	5	4	3,20/2,50	1040
70-100	MEn/7L (5+2)	7	6	4,60	1250

MOD. "SUPER LARGO" (SL) PER FILARI DA mm 900-950-1000 LAVORO mm 670-720-770 (COFANO) / FOR ROWS OF mm 900-950-1000 WORK mm 670-720-770 (BONNET)

40-60	MEn/2SL	2	2	2,00	550
60-75	MEn/3SL (1+2)	3	3	2,40	750

MEn/ = telaio fisso / fixed frame

MEnR/ = telaio pieghevole manuale / mechanical folding frame

MEnI/ = telaio pieghevole idraulico / hydraulic folding frame

OPTIONAL



ME_n/

**zappe
5145B**

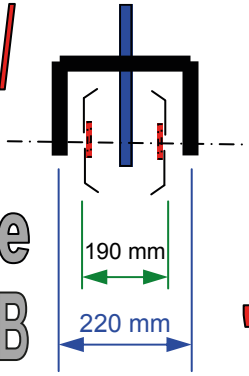

"SS"

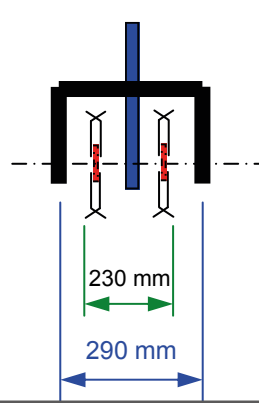

"ST"

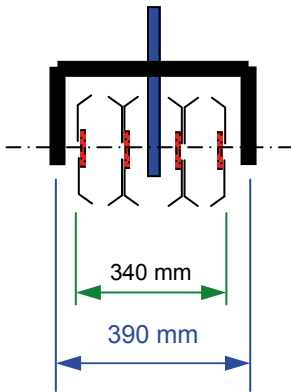
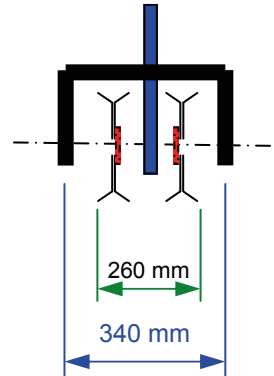

"ML"

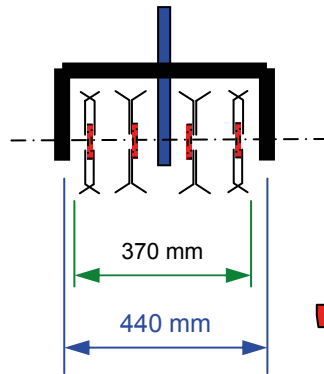

"ML"

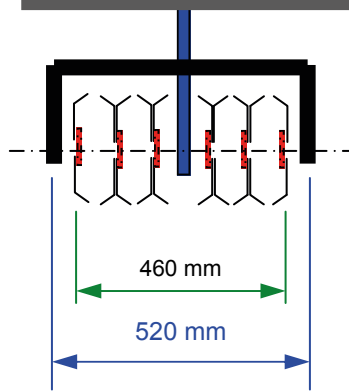
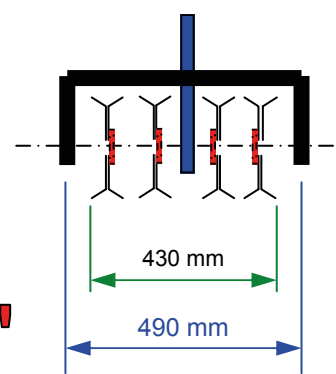

"L"

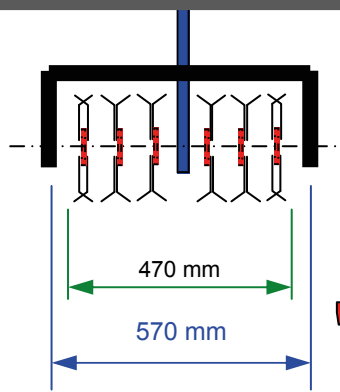

"L"

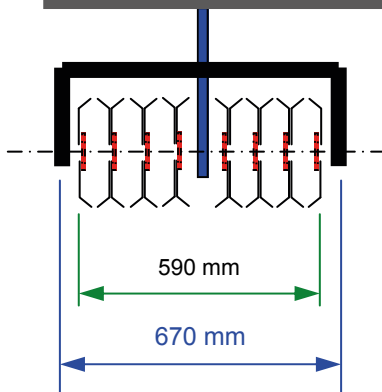
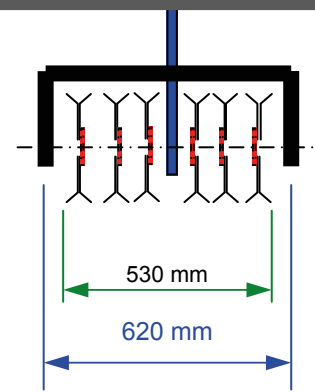

"SL"

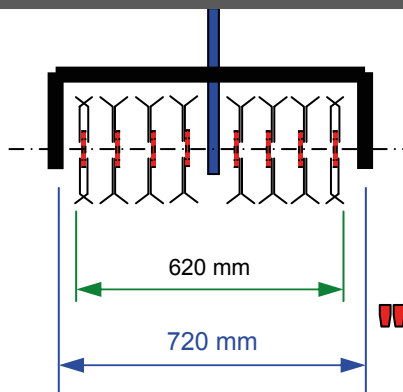

"SL"

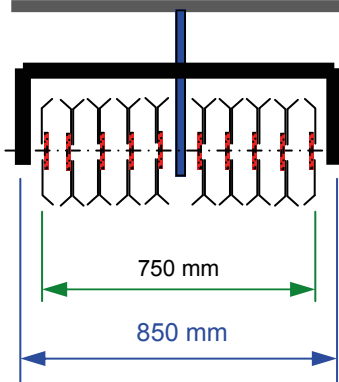
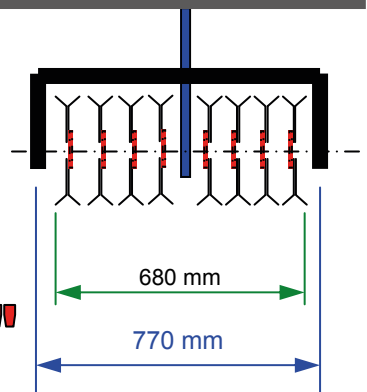

"XL"

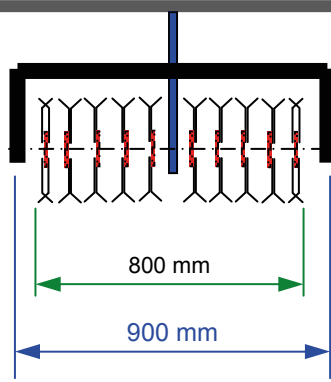

"XL"

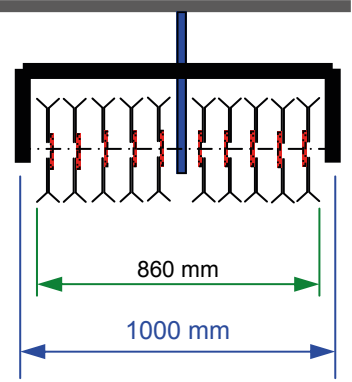





SIRIO

SEZIONE TELAIO FRAME SECTION

DOTAZIONE DI SERIE / STANDARD EQUIPMENT:

Normativa CE / CE Regulations equipments

Albero cardanico con vite di sicurezza / Cardan shaft with safety bolt

Zappe e bulloni alta resistenza / High resistant blades and bolts

Albero trasmissione esagonale 41 mm / Hexagonal transmission shaft = 41 mm

Catene ASA 80-H / Chain ASA 80-H

Telaio in fusione di acciaio / Frame in cast steel

Carter oscillanti / Oscillant protections

Ancora rompitraccia anteriore (optional) / Front tine on each tilling unit (optional)

Scatola catena in fusione con finestra laterale per ispezione / Chain box in cast steel with side window for inspection

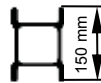

cod. 5145B

mm 50x8

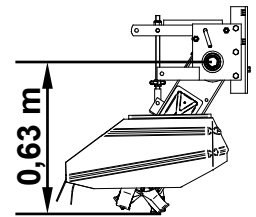

MOD. "STANDARD" (ST) PER FILARI DA mm 450-500 LAVORO mm 290-340 (COFANO) / FOR ROWS OF mm 450-500 WORK mm 290-340 (BONNET)

CV / HP	MODELLO / MODEL	N. CORPI / UNITS NR.	COFANO mm / BONNET mm	TELAIO metri / FRAME meters	PESO Kg / WEIGHT Kg
70-90	MSn/6ST (4+2)	5	4	3,00	900
60-90	MSn/7ST (5+2)	7	6	3,20	1020
60-90	MSnR/7ST (5+2)	7	6	3,20/2,50	1070
80-120	MSn/13ST (11+2)	13	12	6,00	1450
90-120	MSnI/13ST (11+2)	13	12	6,00/3,00	2150

MOD. "MEDIO LARGO" (ML) PER FILARI DA mm 600-650-700 LAVORO mm 400-450-500 (COFANO) / FOR ROWS OF mm 600-650-700 WORK mm 400-450-500 (BONNET)

50-60	MSn/3ML	3	-	2,20	620
70-80	MSn/5ML (3+2)	5	4	3,00	900
70-80	MSnR/5ML (3+2)	5	4	3,20/2,50	1000

MOD. "LARGO" (L) PER FILARI DA mm 700-750-800 LAVORO mm 510-570-620 (COFANO) / FOR ROWS OF mm 700-750-800 WORK mm 510-570-620 (BONNET)

70-90	MSn/5L (3+2)	5	4	3,20	950
70-90	MSnR/5L (3+2)	5	4	3,20/2,50	1050
90-120	MSn/7L (5+2)	7	6	4,60	1250
90-120	MSnI/7L (6+2)	7	6	4,60/2,50	1300
90-120	MSnI/SL (7+2)	9	8	6,00/3,00	1950

MOD. "SUPER LARGO" (SL) PER FILARI DA mm 900-950-1000 LAVORO mm 670-720-770 (COFANO) / FOR ROWS OF mm 900-950-1000 WORK mm 670-720-770 (BONNET)

50-70	MSn/2SL	2	2	2,00	530
60-75	MSn/3SL (1+2)	3	3	2,40	710

MOD. "EXTRA LARGO" (XXL) PER FILARI DA mm 1200-1300 LAVORO mm 1000 (COFANO) / FOR ROWS OF mm 1200-1300 WORK mm 1000 (BONNET)

60-75	MSn/2XL	2	2	2,00	570
-------	---------	---	---	------	-----

MSn/ = telaio fisso / fixed frame

MSnR/ = telaio pieghevole manuale / mechanical folding frame

MSnI/ = telaio pieghevole idraulico / hydraulic folding frame

MSn/

zappe
5145B

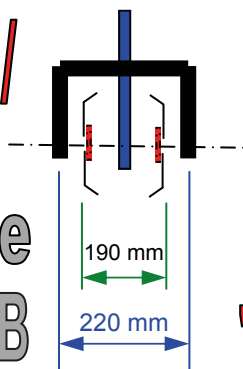

"SS"

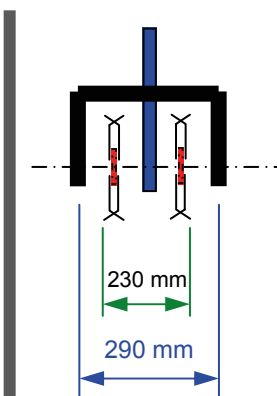

"ST"

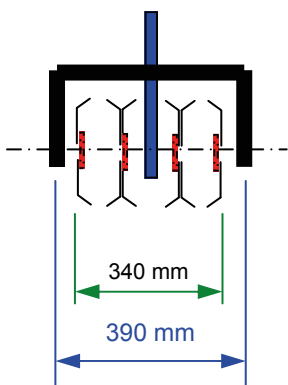
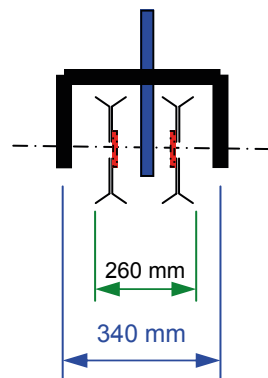

"ML"

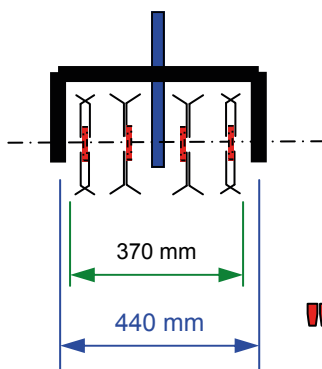

"ML"

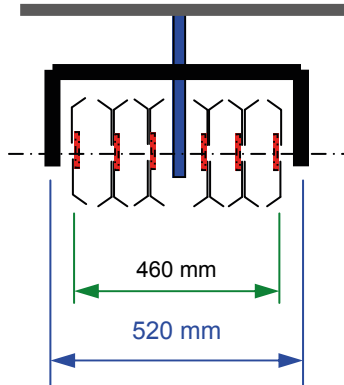
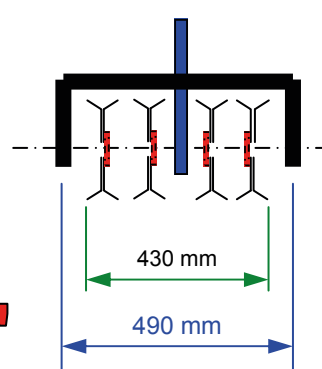

"L"

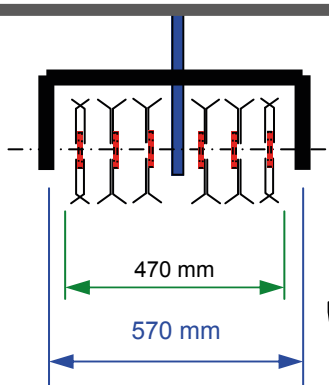

"L"

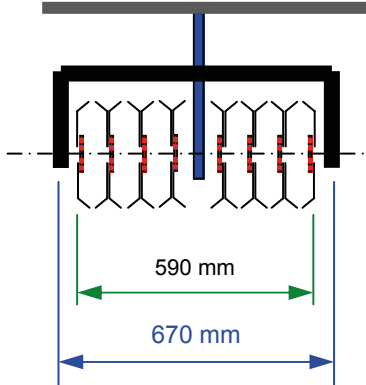
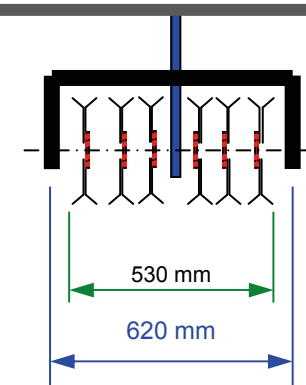

"SL"

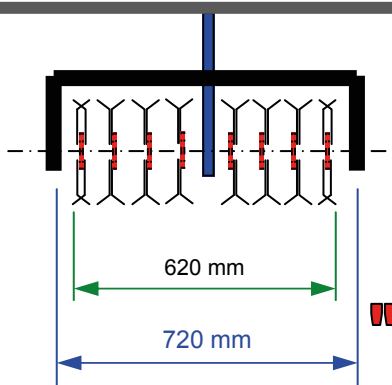

"SL"

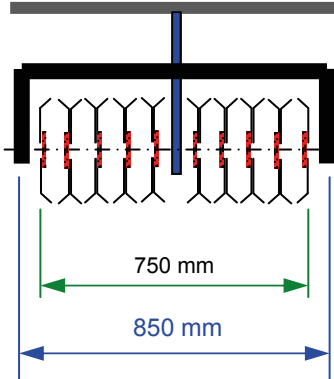
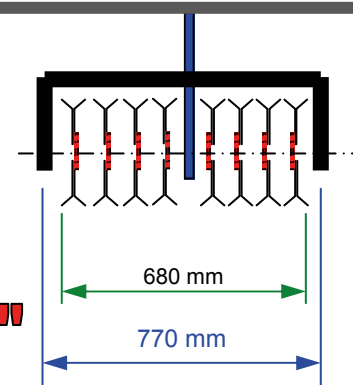

"XL"

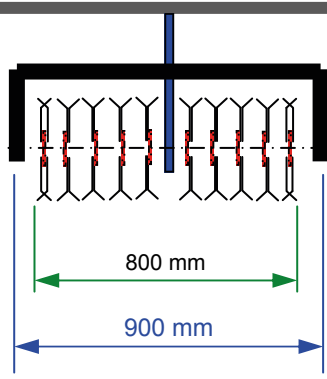

"XL"

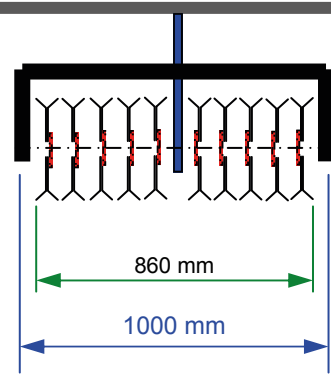

SIRIO





ZEUS



- modelli indicati per settore vivaistico, orticolo, agricolo. Per esempio salici, piccoli alberi, rose, carciofi, fragole, pomodori e qualsiasi altra coltivazione in filari.
 - catene rinforzate, altissima qualità, tipo asa 100h.
 - zappe adatte per affinare, sminuzzare il terreno e renderlo piano per facilitare il lavoro delle macchine raccogliatrici; sono pertanto indicate per colture come pomodori e ortaggi
 - bulloni delle zappe da 12mm, alta resistenza.
 - telaio in estruso, indeformabile, anche in modelli lunghi fino a 6 metri. Facile spostamento dei corpi che scorrono sul telaio come su una rotaia.
 - ancora anteriore su ogni corpo per smuovere il terreno dove non viene lavorato dalle zappe, anche in suoli compatti e duri.
- models suitable for nurseries, vegetables and for agricultural products. For example willows, little trees, roses, artichokes, strawberries, tomatoes and all other cultivation in rows.
 - reinforced high quality chains asa 100h.
 - blades suitable to mince the soil and to make it thin and plain to facilitate the work of harvesting machines; they are proper for cultivations like tomatoes and vegetables.
 - High resistant bolts 12 mm for blades.
 - frame in cast steel that does not bend, also in long models until 6 meters. Easy move of the working units which slide on the frame as on a rail.
 - front tine on each unit to move the soil where it is not worked by the blades, also in compact and hard soils.

DOTAZIONE DI SERIE / STANDARD EQUIPMENT:

Normativa CE / CE Regulations equipments
 Carter oscillanti / Cardan shaft with safety bolt
 Catena ASA 100-H / High resistant blades and bolts
 Zappe e bulloni maggiorati / Hexagonal transmission shaft 50 mm
 Ancora anteriore rinforzata / ASA 100 H Chain
 Albero trasmissione esagonale 50 mm / Hexagonal drive shaft 50 mm
 Albero cardanico con vite di sicurezza / Cardan shaft with safety screw
 Coppia ruote con cuscinetti D=360 mm / Pair of wheels with bearings D = 360 mm
 Scatola catena in fusione con finestra laterale / Chain box in fusion with side window
 Telaio in fusione di acciaio / Frame in cast steel

SEZIONE TELAIO
FRAME SECTION

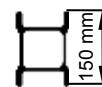

ZEUS
SUPER

MOD. "LARGO" (L) PER FILARI DA mm 300-350 LAVORO mm 185-220 (COFANO) / FOR ROWS OF mm 300-350 WORK mm 185-220 (BONNET)						
CV / HP	MODELLO / MODEL	N. CORPI / UNITS NR.	N. FILARI / ROWS NR.	COFANO / HOOD mm	TELAIO metri / FRAME meters	PESO Kg / WEIGHT Kg
60-80	MZsa/2L	2	2	520-620-670	2,20	360
70-90	MZsa/3L	3	3	520-620-670	2,40	470
80-100	MZsa/5L	5	4	520-620-670	3,00	560
MOD. "SUPER LARGO" (SL) PER FILARI DA mm 450-500 LAVORO mm 290-340 (COFANO) / FOR ROWS OF mm 450-500 WORK mm 290-340 (BONNET)						
60-80	MZsa/2sL	2	2	700-800-850	2,00	360
70-90	MZsa/3sL	3	3	700-800-850	2,40	470
80-120	MZsa/5 (3SL+2L)	5	4	700-800-850	4,50	560
MOD. "EXTRA LARGO" (XL) PER FILARI DA mm 600-650-700 LAVORO mm 390-440-490 (COFANO) / FOR ROWS OF mm 600-650-700 WORK mm 390-440-490 (BONNET)						
60-80	MZsa/2XL	2	2	900-1050-1100	2,00	740
70-100	MZsa/3XL	3	3	900-1050-1100	2,40	930
80-120	MZsa/4 (2XL+2SL)	5	3	900-1050-1100	IDRAULICO / HYDRAULIC	1400
80-120	MZsa/5 (3XL+2L)	5	4	900-1050-1100	4,50	1450
MOD. "EXT.EXT.LARGO" (XXL) PER FILARI DA mm 700-750-800 LAVORO mm 540-590-650 (COFANO) / FOR ROWS OF mm 700-750-800 WORK mm 540-590-650 (BONNET)						
60-80	MZsa/2XXL	2	2	1120-1220-1320	2,40	740
70-100	MZsa/3XXL	3	3	1120-1220-1320	2,40	950

MZsa/es 50

zappe
5802

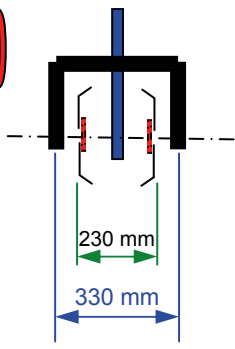

"ST"

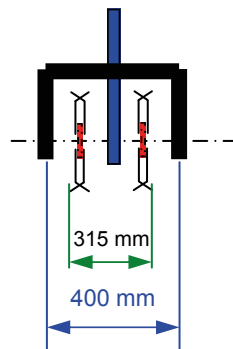

"ML"

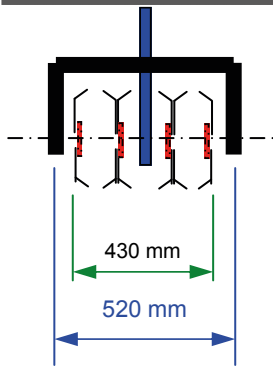
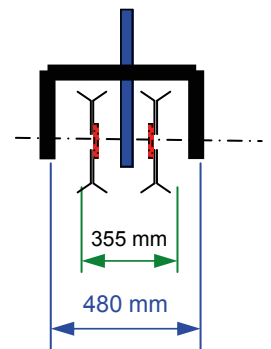

"L"

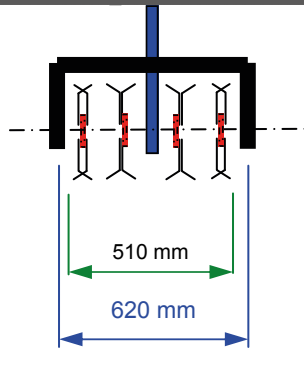

"L"

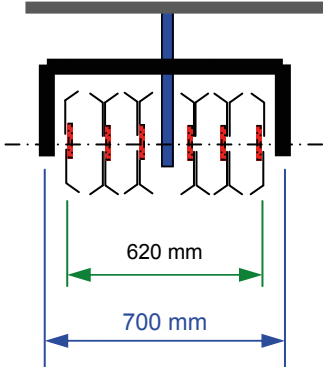
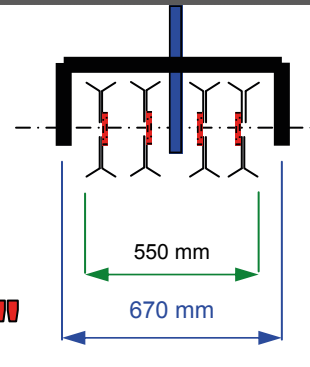

"SL"

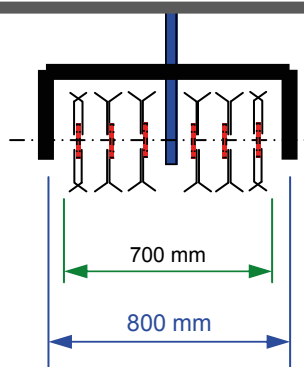

"SL"

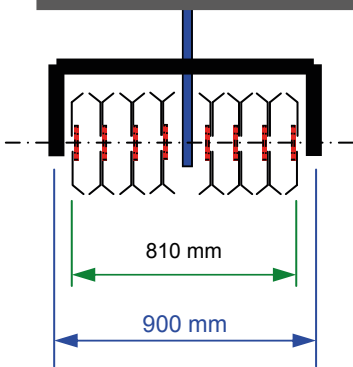
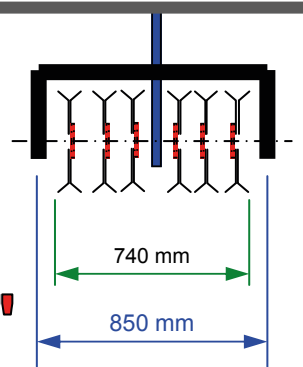

"XL"

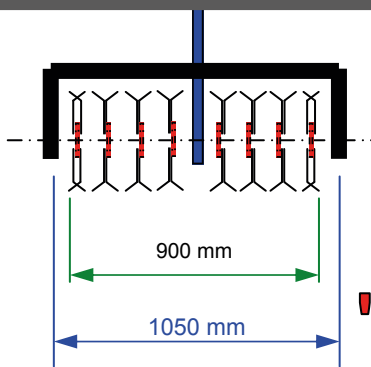

"XL"

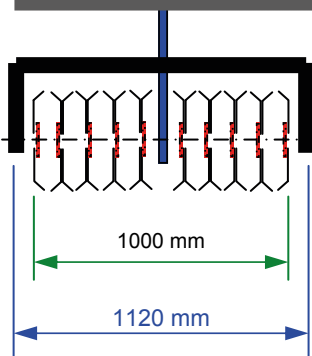
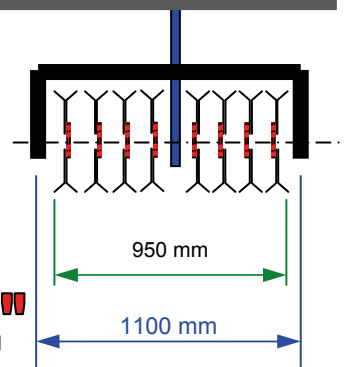

"XXL"

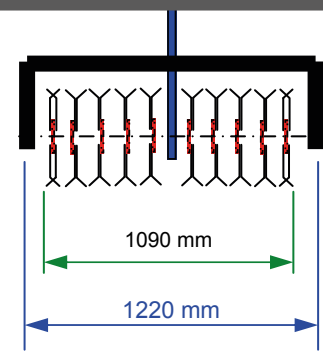

"XXL"

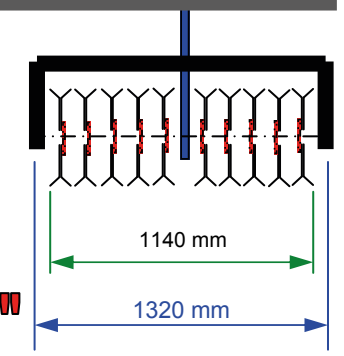

ZEUS

SUPER 5802

MULTIFRESA SPECIALE



ZEUS

SUPER 8914

MULTIFRESA SPECIALE



MZs/

- Modelli indicati per settore **vivaistico, orticolo, agricolo**. Per esempio salici, piccoli alberi, rose, carciofi, fragole, pomodori e qualsiasi altra coltivazione in filari.
 - **catene** rinforzate, altissima qualità, tipo asa 100 H.
 - **zappe** maggiorate con bulloni alta resistenza di 12mm per lavori pesanti anche in profondità e in terreni duri, argillosi, pietrosi..
 - **telaio in estruso, indeformabile**, anche in modelli lunghi fino a 6 metri. Facile spostamento dei corpi che scorrono sul telaio come su una rotaia.
 - **ancora anteriore** su ogni corpo per smuovere il terreno dove non viene lavorato dalle zappe, anche in suoli compatti e duri.
 - **differenze:**
- *models suitable for nurseries, vegetables and for agricultural products. For example willows, little trees, roses, artichokes, strawberries, tomatoes and all other cultivation in rows.*
 - *reinforced high quality chains asa 100 H.*
 - *stiffened blades with high resistant bolts of 12mm for heavy work also in depth and for hard, clayey and stony soils.*
 - *Frame in cast steel that does not bend, also in long models until 6 meters. Easy move of the working units which slide on the frame as on a rail.*
 - *Front tine on each unit to move the soil where it is not worked by the blades, also in compact and hard soils.*
 - *Differences:*

DOTAZIONE DI SERIE / STANDARD EQUIPMENT:

Normativa CE / CE Regulations equipments

Carter oscillanti / Cardan shaft with safety bolt

Catena ASA 100-H / High resistant blades and bolts

Zappe e bulloni maggiorati / Hexagonal transmission shaft 50 mm

Ancora anteriore rinforzata / ASA 100 H Chain

Albero trasmissione esagonale 50 mm / Strengthened front tine

Albero cardanico con vite di sicurezza / Oscillat protections

Coppia ruote con cuscinetti D=360 mm / Couple wheels with bearings D=360 mm

Scatola catena in fusione con finestra laterale / Chain box in cast steel with side window

Telaio in fusione di acciaio / Frame in cast steel

**SEZIONE TELAIO
FRAME SECTION**



**ZEUS
SUPER**

MOD. "LARGO" (L) PER FILARI DA mm 700-750-800 LAVORO mm 480-520 (COFANO) / FOR ROWS OF mm 700-750-800 WORK mm 480-520 (BONNET)						
CV / HP	MODELLO / MODEL	N. CORPI / UNITS NR.	N. FILARI / ROWS NR.	COFANO / HOOD mm	TELAIO metri / FRAME meters	PESO Kg / WEIGHT Kg
60-80	MZs/2L	2	2	480-520	2,00	560
70-90	MZs/3L	3	3	480-520	2,40	710
80-100	MZs/5L	5	4	480-520	3,00	1150
MOD. "SUPER LARGO" (SL) PER FILARI DA mm 900-950-1000 LAVORO mm 670-850 (COFANO) / FOR ROWS OF mm 900-950-1000 WORK mm 670-850 (BONNET)						
60-80	MZs/2sL	2	2	670-780-850	2,00	680
70-90	MZs/3sL	3	3	670-780-850	2,40	850
80-120	MZs/5 (3SL+2L)	5	4	670-780-850	4,50	1350
MOD. "EXTRA LARGO" (XL) PER FILARI DA mm 1200-1300 LAVORO mm 1000-1160 (COFANO) / FOR ROWS OF mm 1200-1300 WORK mm 1000-1160 (BONNET)						
60-80	MZs/2XL	2	2	1000-1100-1160	2,00	740
70-100	MZs/3XL	3	3	1000-1100-1160	2,40	930
80-120	MZs/5 (3XL+2L)	5	3	1000-1100-1160	4,50	1450
MOD. "EXT.EXT.LARGO" (XXL) PER FILARI DA mm 1300-1600 LAVORO mm 1300-1550 (COFANO) / FOR ROWS OF mm 1300-1600 WORK mm 1300-1550 (BONNET)						
80-120	MZs/2XXL	2	2	1300-1400-1550	2,40	740
60-80	MZs/3XXL	3	3	1300-1400-1550	2,40	950
70-100	MZs/4 (2XXL/2SL)	5	3	1300-1400-1550	IDRAULICO / HYDRAULIC	1400

MZs/ es 50

zappe
8914

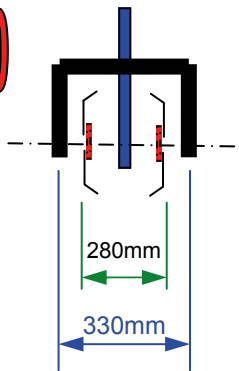

"ML"

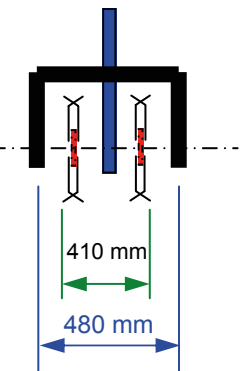

"L"

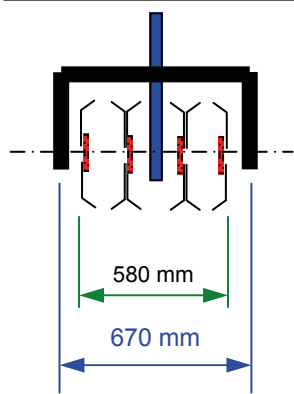
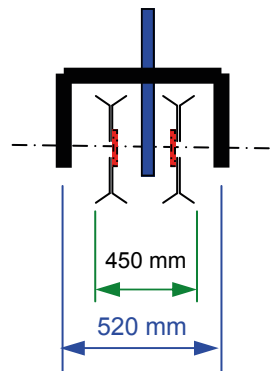

"SL"

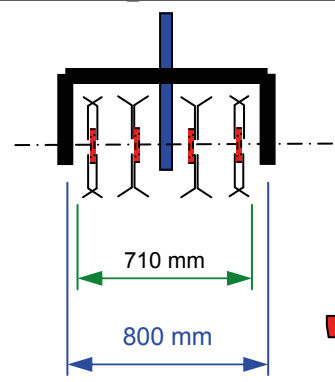

"SL"

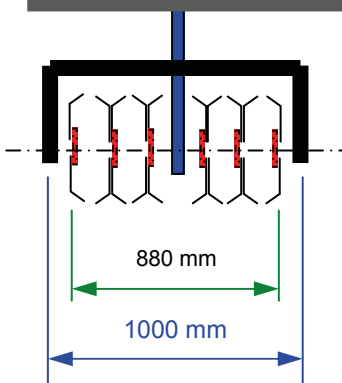
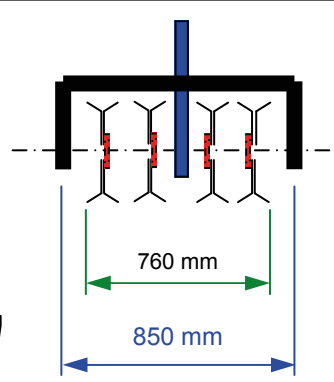

"XL"

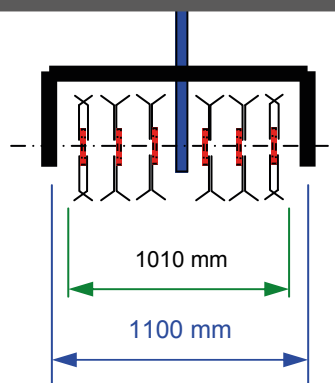

"XL"

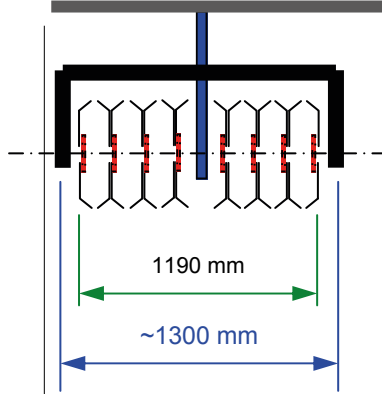
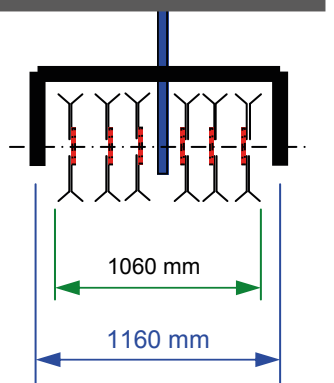

"XXL"

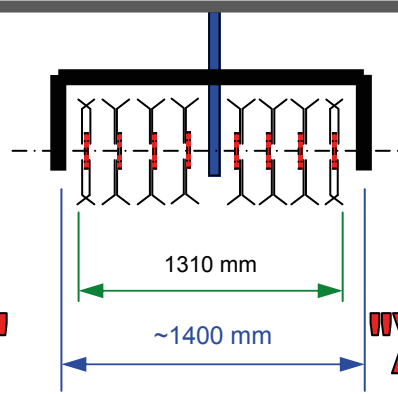

"XXL"

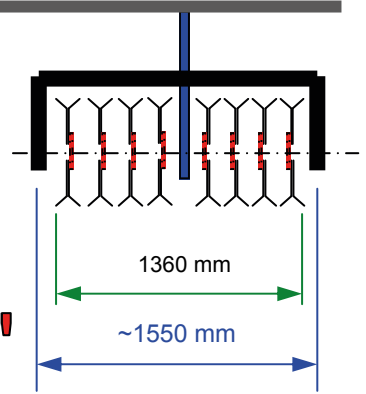



ZEUS





TITANO



MTs/

CATENA: ASA 120 ALBERO: 50 mm

DOTAZIONE DI SERIE / STANDARD EQUIPMENT:

Normativa CE / *CE Regulations equipments*

Albero cardanico con vite di sicurezza / *Cardan shaft with safety bolt*

Zappe e bulloni alta resistenza / *High resistant blades and bolts*

Albero trasmissione esagonale 50 mm / *Hexagonal transmission shaft = 50 mm*

Catene ASA 120-H / *hain ASA 120-H*

Coppia ruote con cuscinetti D=360 mm / *Couple wheels with bearings D=360 mm*

Scatola catena in fusione con finestra laterale per ispezione / *Chain box in cast steel with side window for inspection*

Ancora anteriore rinforzata / *Strengthened front tine*

Telaio in fusione di acciaio / *Frame in cast steel*

SEZIONE TELAIO FRAME SECTION



MOD. "LARGO" (L) PER FILARI DA mm 750-800 LAVORO mm 580 (COFANO) / FOR ROWS OF mm 750-800 WORK mm 580 (BONNET)					
CV / HP	MODELLO / MODEL	N. CORPI / UNITS NR.	COFANO mm / BONNET mm	TELAIO metri / FRAME meters	PESO Kg / WEIGHT Kg
70-100	MTs/2L	2	580	2,00	850
MOD. "SUPER LARGO" (SL) PER FILARI DA mm 900-1000 LAVORO mm 660-740-810 (COFANO) / FOR ROWS OF mm 900-1000 WORK mm 660-740-810 (BONNET)					
70-100	MTs/2SL	2	660-740-810	2,00	900
70-100	MTs/2SL	2	660-740-810	2,40	900
MOD. "EXTRA LARGO" (XL) PER FILARI DA mm 1000-1200 LAVORO mm 810-890-1080 (COFANO)					
70-110	MTs/2XL	2	810-890-1040	2,40	920
MOD. "EXTRA EXTRA LARGO" (XXL) PER FILARI DA mm 1400-1800 LAVORO mm 1200-1500 (COFANO) / FOR ROWS OF mm 1400-1800 WORK mm 1200-1500 (BONNET)					
70-110	MTs/2XXL	2	1200-1500	2,40	960
100-130	MTs/3 (2XXL+2L)	3	1200-1500	3,80	1200
100-130	MTs/3 (2XXL+2L)	3	1200-1500	IDRAULICO / HYDRAULIC	1500
100-130	MTs/4 (2XXL+2SL)	4	1200-1500	IDRAULICO / HYDRAULIC	1700

cod. 5261

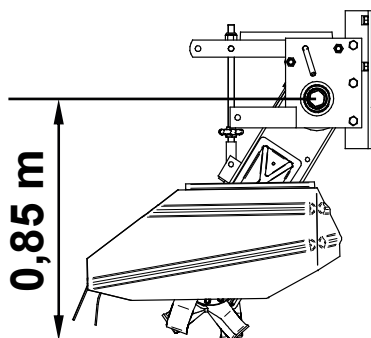
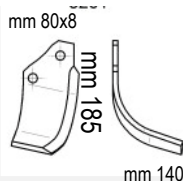

MTs/ es 50

**zappe
5261**

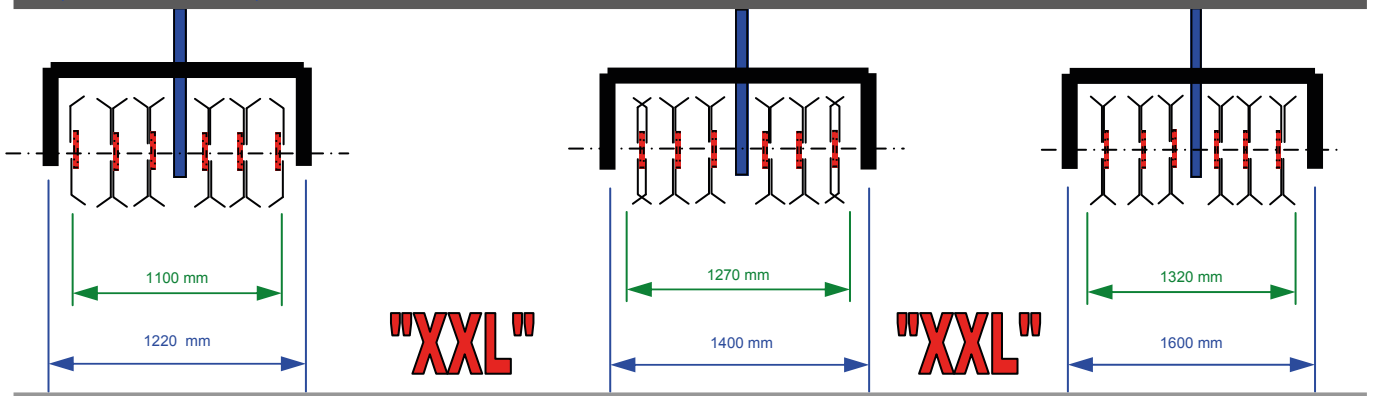
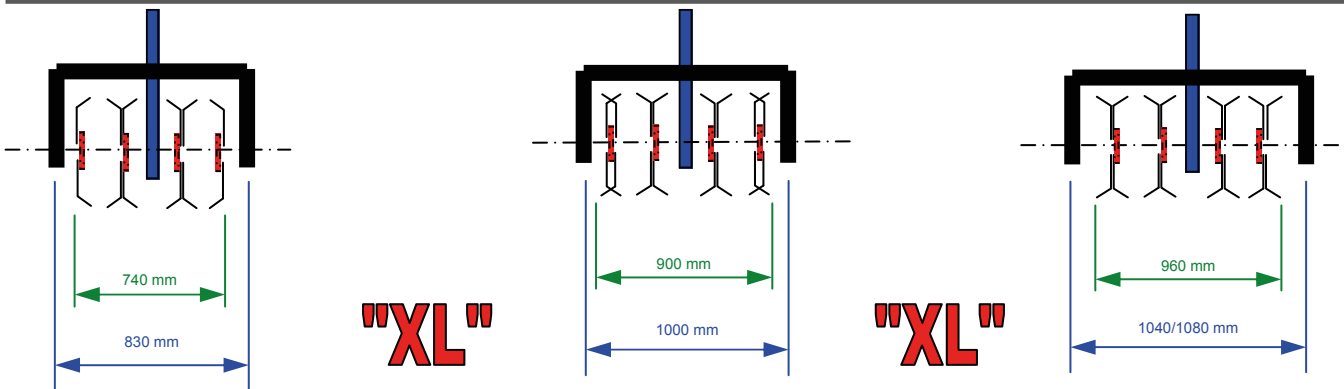
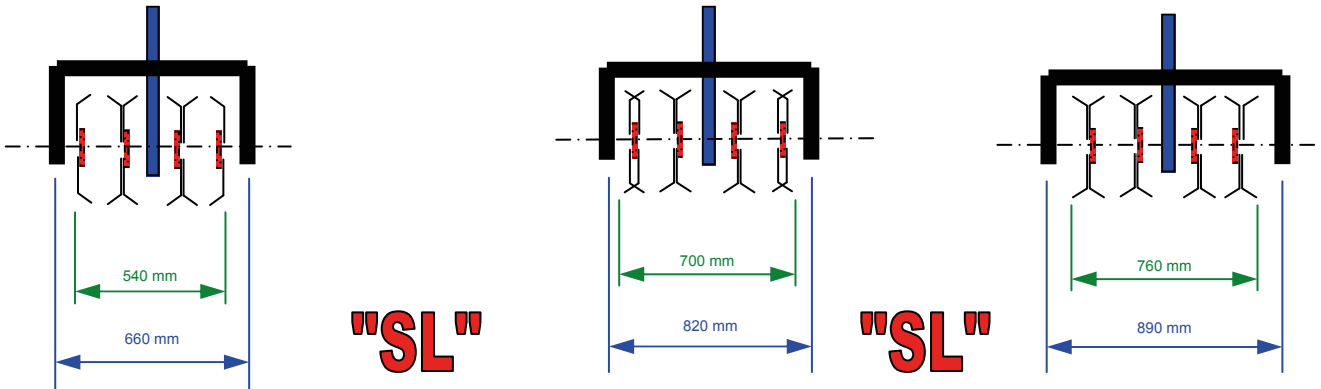
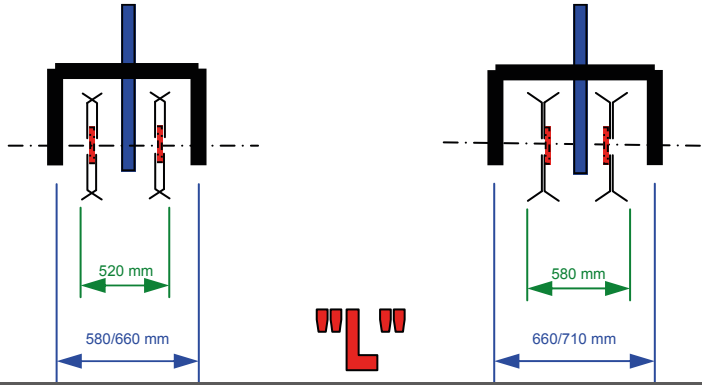

INTERRASASSI

MTx/

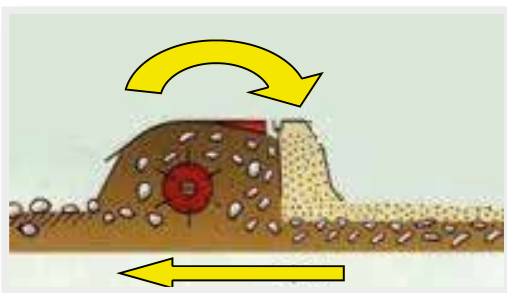

SEZIONE TELAIO

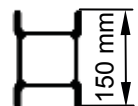

cod. 5261

mm 80x8

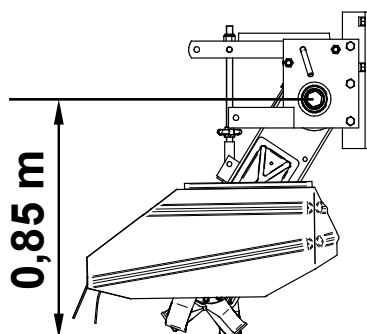
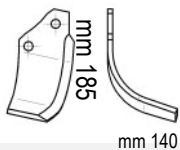

DOTAZIONE DI SERIE / STANDARD EQUIPMENT:

Normativa CE / *EC safety guards*

Albero cardanico con vite di sicurezza / *Cardan shaft with safety bolts*

Zappe e bulloni super maggiorati / *Oversized blades and bolts*

Albero trasmissione esagonale 50 mm / *Hexagonal transmission shaft = 50 mm*

Catena ASA 120 / *Chain ASA 120*

Coppia ruote con cuscinetti D=360 mm / *Couple wheels with bearings D=360 mm*

Scatola catena in fusione con finestra laterale / *Chain box in cast steel with side window*

Ancora anteriore rinforzata / *Strengthened front tine*

Telaio in fusione di acciaio / *Frame in cast steel*



MOD. "EXTRA LARGE" (XL) PER FILARI DA mm 1000-1800 LAVORO mm 810 (COFANO) / FOR ROWS OF mm 1000-1800 WORK mm 810 (BONNET)

CV / HP	MODELLO / MODEL	N. CORPI / UNITS NR.	N. FILARI / ROWS NR.	COFANO mm / BONNET mm	TELAIO metri / FRAME meters	PESO Kg / WEIGHT Kg
80-110	MTx/2XL	2	2	810	2,40	1000
80-130	MTx/3XL	3	3	810	3,00	1250

A RICHIESTA / ON REQUEST:

Martinetto regolazione corpi laterali

Maniglie regolazione laterali

Riduttore 1000 giri

Transmission shaft protections

Hydraulic cylinders for regulation of side units

Side handles for regulation

1000 rpm gear box







ZEUS SUPER

MZxa/

**PROFONDITÀ DI LAVORO 180mm /
WORKING DEPTH 180 MM**

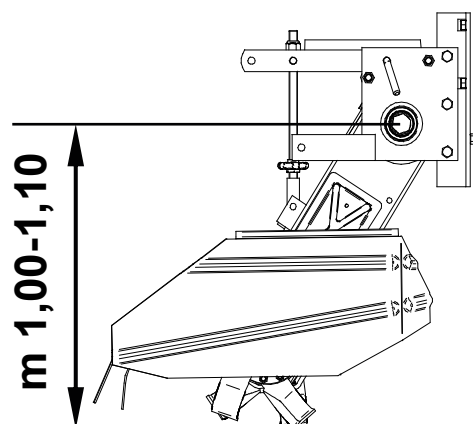

DOTAZIONE DI SERIE / STANDARD EQUIPMENT:

Normativa CE / *CE Regulations equipments*

Carter oscillanti / *Oscillant protections*

Catene ASA 100 H / *Chain ASA 100 H*

Telaio in fusione di acciaio / *Frame in cast steel*

Zappe e bulloni maggiorati / *Zappe and oversized bolts*

Albero cardanico con vite di sicurezza / *Cardan shaft with safety bolt*

Albero trasmissione esagonale 50 mm / *Hexagonal drive shaft 50 mm*

Coppia ruote con cuscinetti D=360 mm / *Couple wheels with bearings D=360 mm*

Scatola catena in fusione con finestra laterale per ispezione / *Chain box in cast steel with side window for inspection*

Ancora anteriore rinforzata / *Reinforced front anchor*

Altezza sotto riduttore 750mm/850mm/950mm / *Height under gear box 750mm / 850mm / 950mm*

MOD. "MEDIO LARGO" (ML) PER FILARI DA mm 500-550-600 LAVORO mm 400-480 (COFANO) / FOR ROWS OF mm 500-550-600 WORK mm 400-480 (BONNET)						
CV / HP	MODELLO / MODEL	N. CORPI / UNITS NR.	N. FILARI / ROWS NR.	COFANO / HOOD mm	TELAIO metri / FRAME meters	PESO Kg / WEIGHT Kg
70-100	MZxa/2ML	2	2	400-480	3,00	800
90-120	MZxa/3ML	3	3	400-480	4,00	1050
MOD. "LARGO" (L) PER FILARI DA mm 700-750-800 LAVORO mm 520-670 (COFANO) / FOR ROWS OF mm 700-750-800 WORK mm 520-670 (BONNET)						
70-100	MZxa/2L	2	2	520-620-670	3,00	850
90-120	MZxa/3L	3	3	520-620-670	4,00	1100
MOD. "SUPER LARGO" (SL) PER FILARI DA mm 900-950-1000 LAVORO mm 700-850 (COFANO) / FOR ROWS OF mm 900-950-1000 WORK mm 700-850 (BONNET)						
80-110	MZxa/2SL	2	2	700-800-850	3,00	950
90-120	MZxa/3SL	3	3	700-800-850	4,00	1200
MOD. "EXTRA LARGO" (XL) PER FILARI DA mm 1200-1300 LAVORO mm 900-1100 (COFANO) / FOR ROWS OF mm 1200-1300 WORK mm 900-1100 (BONNET)						
90-120	MZxa/2XL	2	2	900-1050-1100	3,00	1000
90-120	MZxa/3XL	3	3	900-1050-1100	4,00	1300
MOD. "EXT.EXT.LARGO" (XXL) PER FILARI DA mm 1300-1600 LAVORO mm 1120-1220-1320 (COFANO) / FOR ROWS OF mm 1300-1600 WORK mm 1120-1220-1320 (BONNET)						
80-110	MZxa/2XXL	2	2	1120-1220-1320	3,00	1050
90-120	MZxa/3XXL	3	3	1120-1220-1320	4,00	1350

MZxa/
esag. 50
zappe
5802

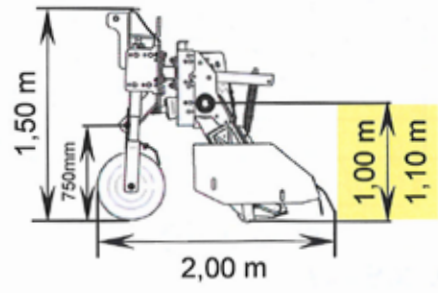
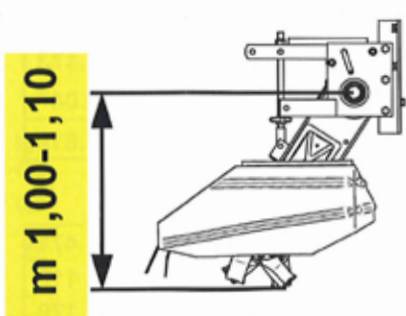
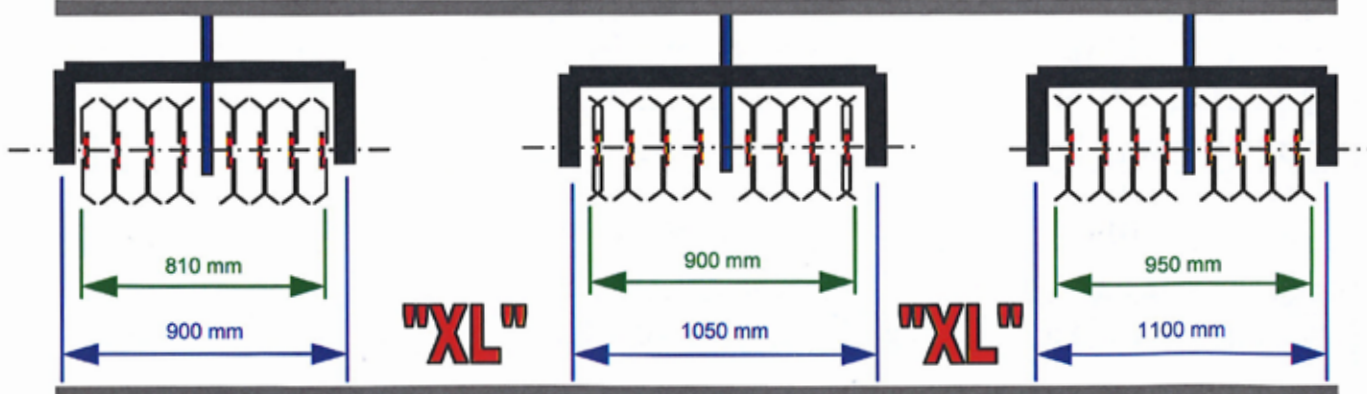
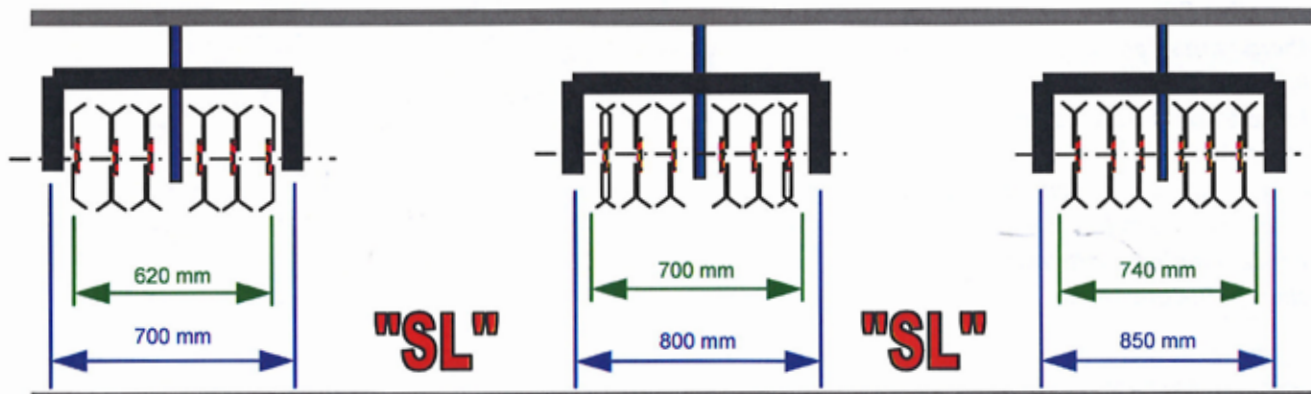
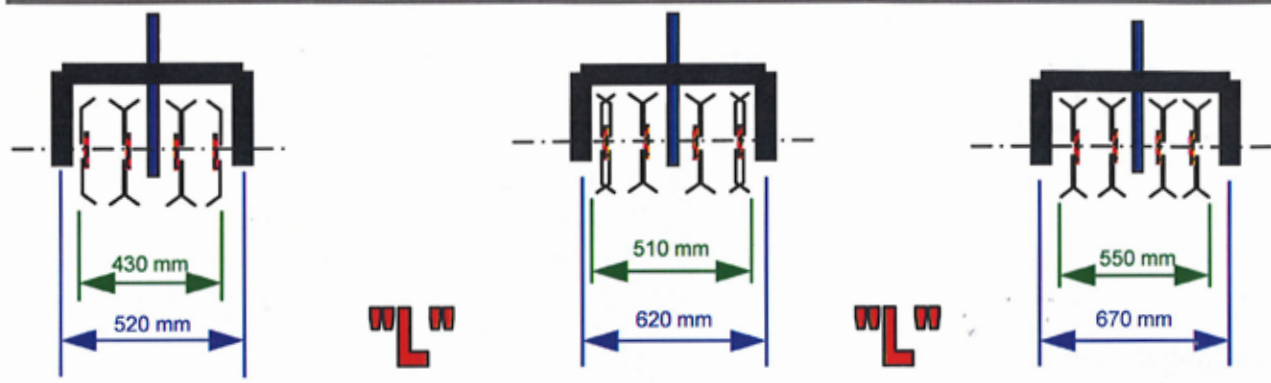
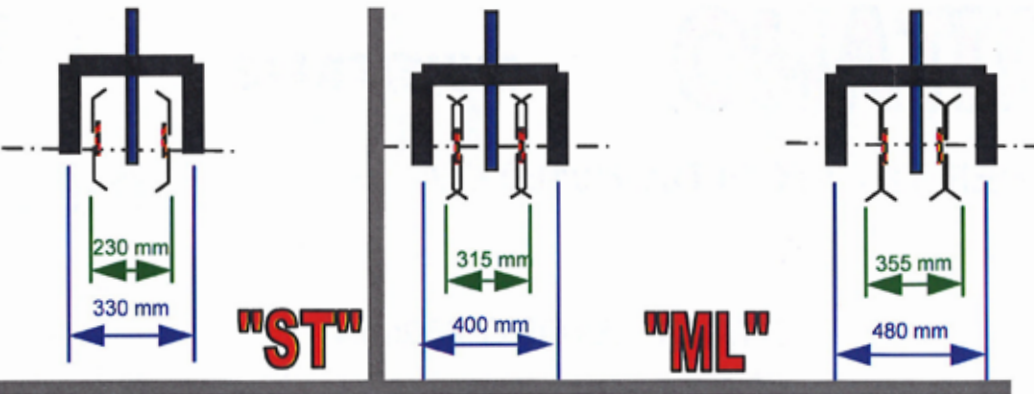

cod. 5802





www.badalini.it



Badalini macchine agricole



BADALINI S.R.L.

Sede Legale: Strada DELMONA 1 - 46017 RIVAROLO MANTOVANO (Mantova)

Capitale Sociale: Euro 650.000,00 i.v.

TEL. 0039/0376/99149 r.a. FAX 0039/0376/99641

C.F. e N.ro Iscrizione Registro Imprese di Mantova 02118990205 - P.I. IT 02118990205

Iscritta al R.E.A. di Mantova al N. 225600 MN

badalini@badalini.it