

NOTICE DE MONTAGE
Istruzioni per l'installazione
Assembly instruction

réf. NAU 3535.02
ref. NAU 3535.02
ref. NAU 3535.02

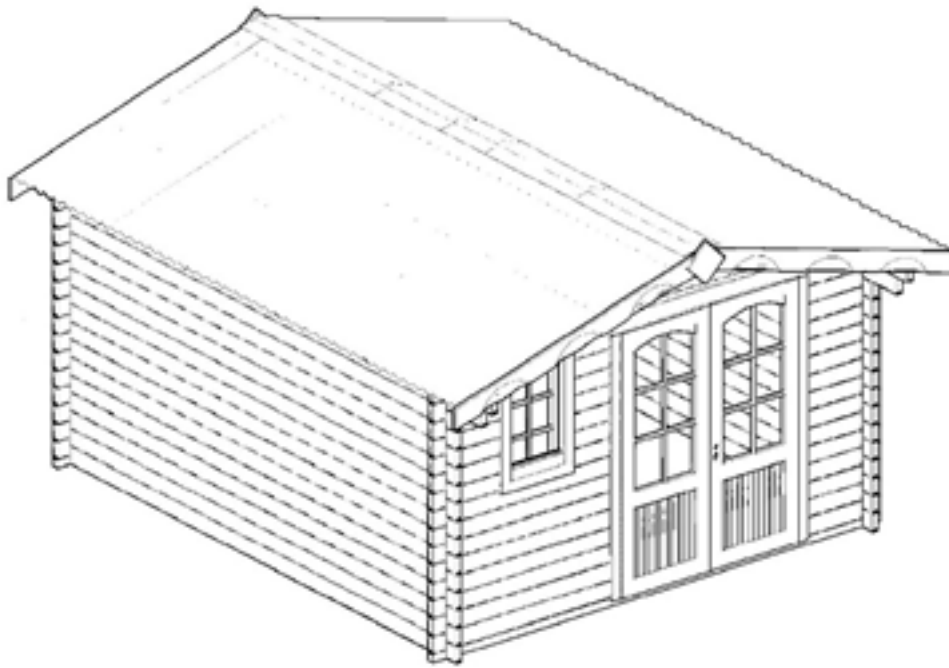

Surf. au sol / Superf. interna netta/ Internal surface : 12,25 m²

Surf. hors tout / Superficie totale/ Total surface : 15,73 m²

Pente de toit/ Pendenza tetto/ Roof slope : 13°

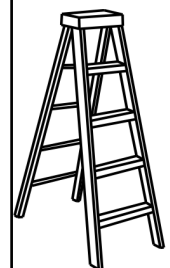
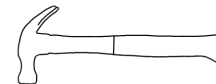

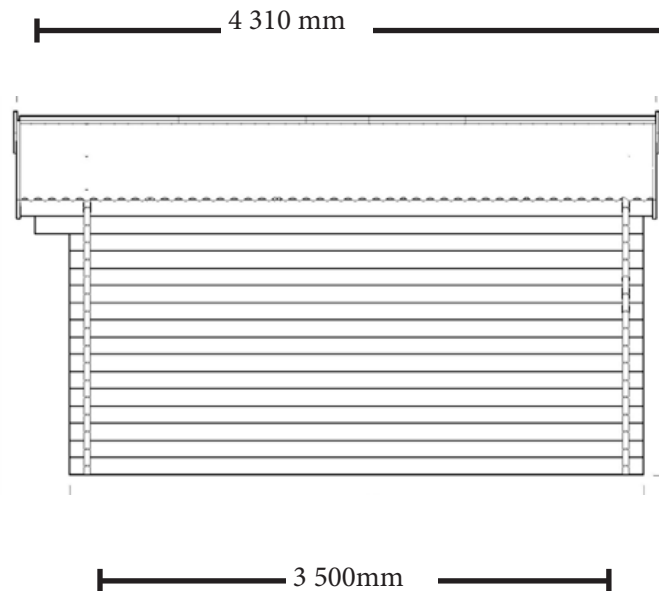
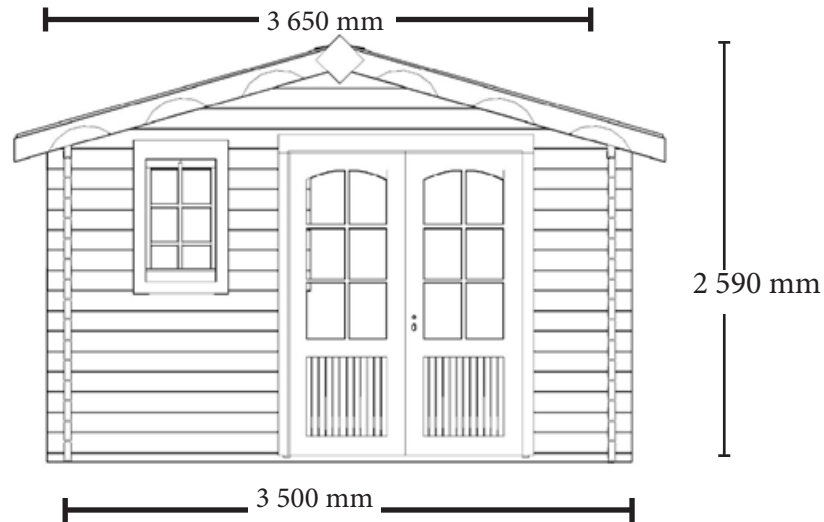

Plan de soubassement NAU 3535.02

Piano di basamento NAU 3535.02

Basement plan NAU 3535.02

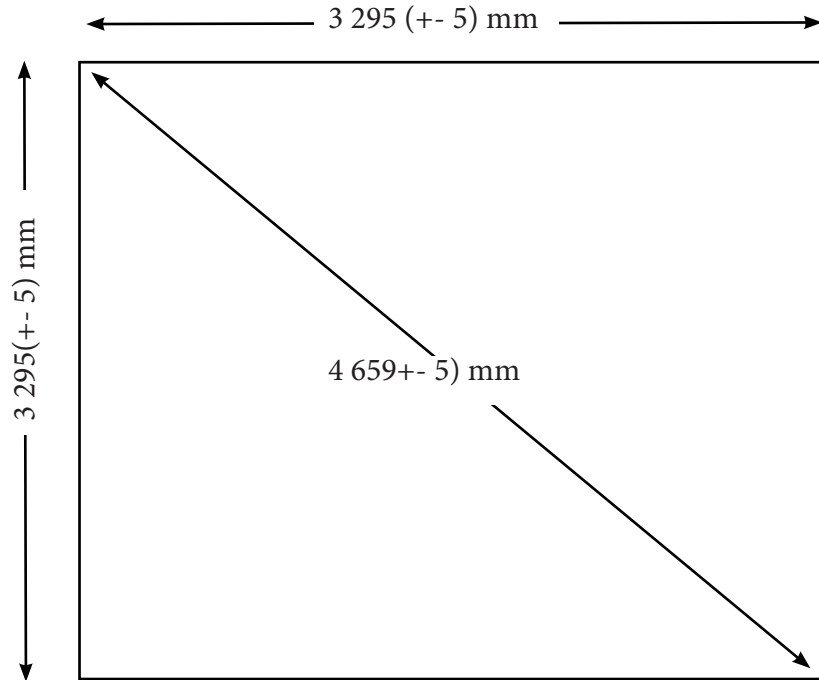





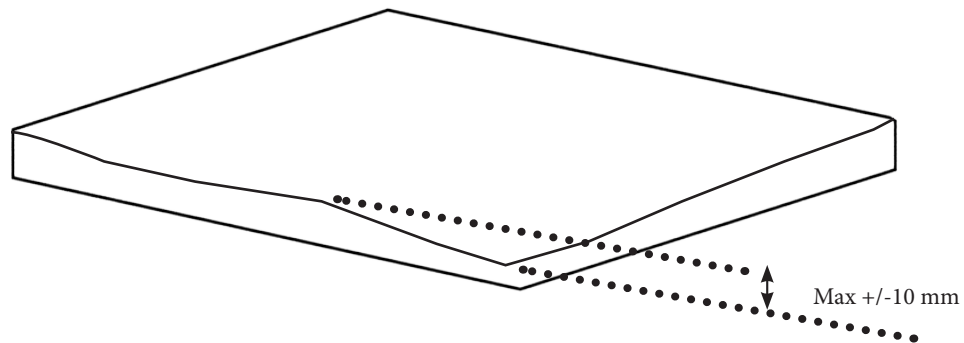

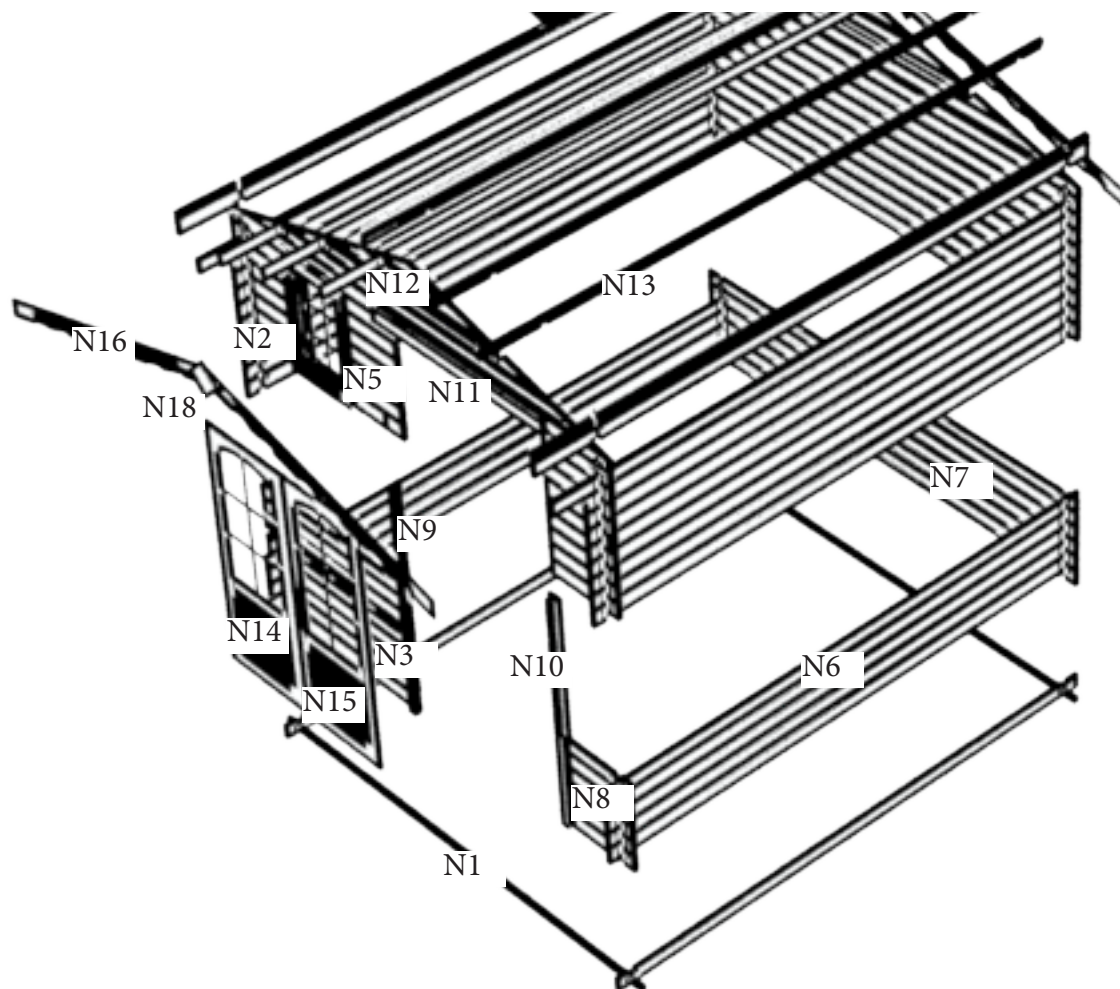











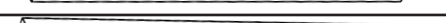









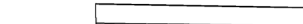
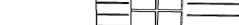

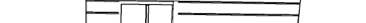

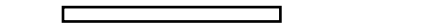
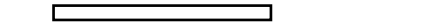



Les dimensions données sur le plan de soubassement sont les dimensions de la dalle béton à réaliser sur un sol parfaitement plat sans aucun autre objet extérieur type mur, clôture ou arbre dans l'entourage de la dalle. Si le produit est implanté près d'un mur, d'une haie ou d'un arbre il est nécessaire de l'éloigner des éléments extérieurs afin de pouvoir facilement le monter et l'entretenir. Nous nous dégageons de toute responsabilité en cas de mauvaise interprétation des dimensions de la dalle.

Le dimensioni del piano di base sono le dimensioni della soletta di cemento da realizzare su un terreno perfettamente piatto, senza alcun altro oggetto esterno, come un muro, una recinzione o un albero in prossimità della soletta. Se il prodotto è installato vicino ad una parete, un recinto o un albero, è necessario distanziarlo adeguatamente, in modo da poterlo facilmente montare e farne la manutenzione. Non ci assumiamo alcuna responsabilità per l'errata interpretazione delle dimensioni della lastra.





N°	REF	DES.	DIM (mm)	QTE	PLAN	Demandas	
						OBS	QTE
1	I42.2.3500		3500x55x42	2			
2	L42.1.575		575x108x42	7			
3	L42.1.1525		1525x108x42	8			
5	L42.1.435		435x108x42	7			
6	L42.2.3500		3500x108x42	28			
7	L42.2.3500		3500x108x42	16			
7'	L42.2.3500d		3500x108x42	1			
8	L42.1.495		495x108x42	15			
9	TLS 1840.20		1845x80x90	1			
10	TLD 1840.20		1845x80x90	1			
11	TS1550.42		1550x120x90	1			
12	F42.3500.600		3500x600x62	2			
13	FI40.3500.495		3500x495x62	1			
14	GC2480.90		2480x90x40	1			
15	GC1850.90		1850x90x40	1			
16	GL2480.90		2480x90x40	2			
17	GL1850.90		1850x90x40				
18	UD1800.800		1800x800x40	1			
19	US1800.800		1800x800x40	1			
20	DSF2000.90		2000x130x20	2			
21	DL1820.90		1820x90x20	2			
22	DL2450.90		2450x90x20	2			
24	DSF2000.90		2000x130x20	2			
25	R150.90		150x90x20	2			
26	F785.385		785x385x82	1			
27	A16.1925		1925x95x16	102			
28	LS42.2.3740		3740x130x42	2			
29	LSS42.2.3980		3980x130x30	2			
31	LSD42.2.1344		1344x190x42	1			
	LSS42.2.2986		2986x190x42	1			
32	LSD42.2.1344		1344x190x42	1			
	LSD42.2.2986		2986x190x42	1			
33	DP1800.60		1800x60x16	1			

34	Vis 4 x 45		4 x 45	46		
35	Clous L100		100	6		
36	Vis 3,0 x 30		3X30	12		
37	Clous L40			350		
38	Clous L16			350		
39	Serrure		80x 60 x2	1		
40	Verrou a douille			2		
41	Vis 3,5 x 35		3.5X35	10		
42	Bardeau bitume		4400x1000x2	4		

Demande sav

A compléter impérativement pour toute demande SAV et à envoyer par mail à sav@foresta.fr + photo des pièces abîmées (To be completed imperatively + Photo of damaged parts)

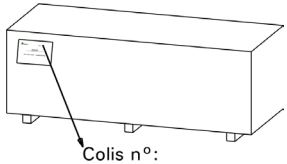
	NAU 3535.02 <u>Colis(package) n° :</u>	MAGASIN (STORE)	
		NOM (NAME) CLIENT	
		PRENOM(PRE.) CLIENT	
		TEL.	

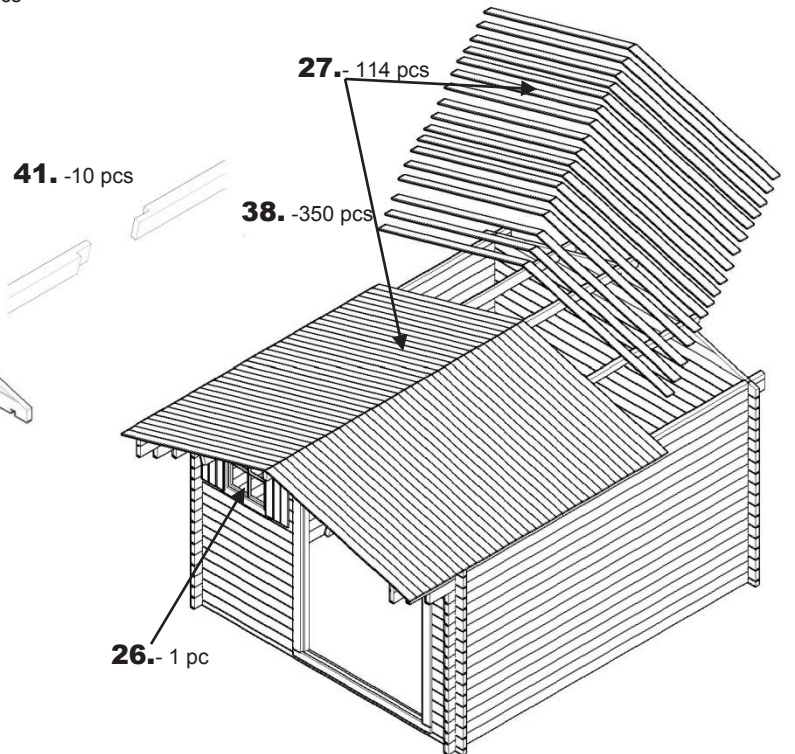
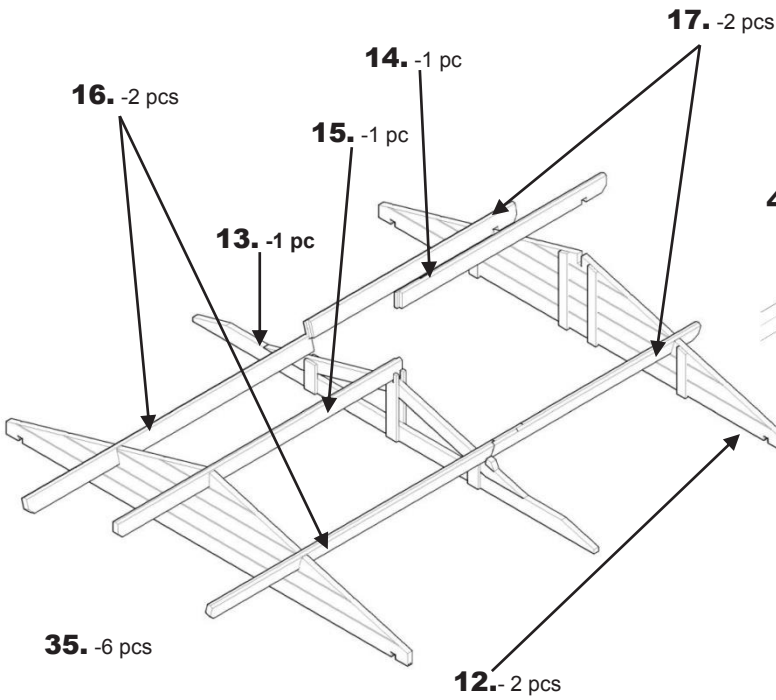
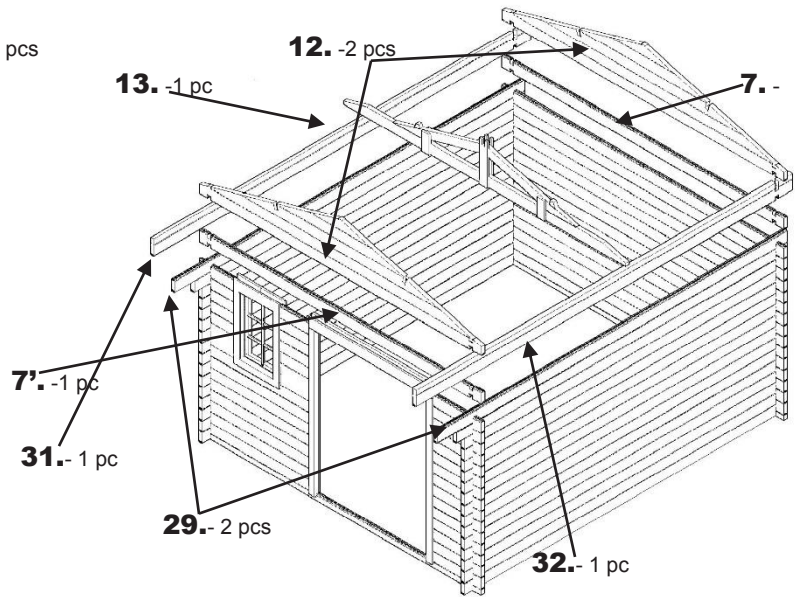
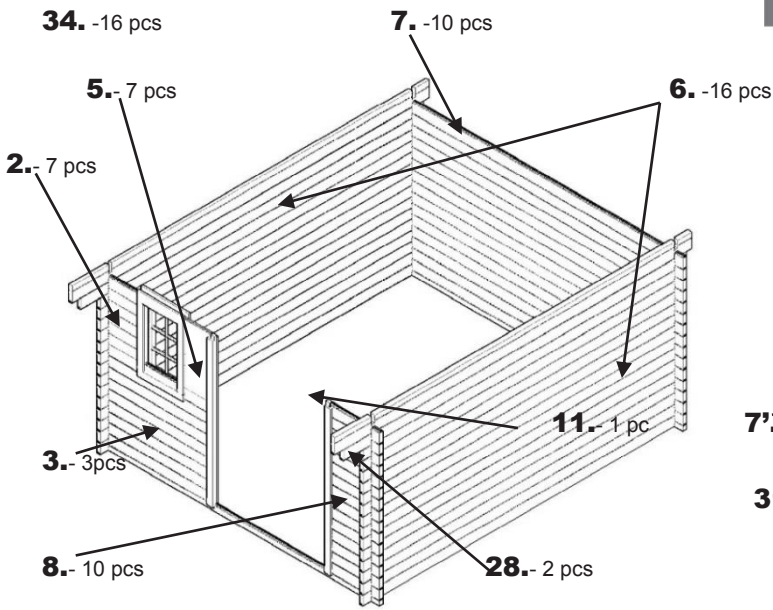
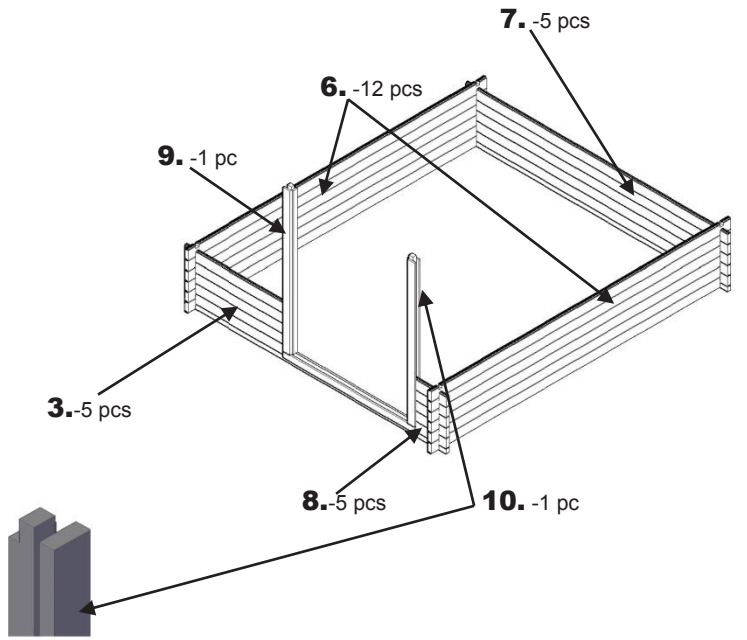
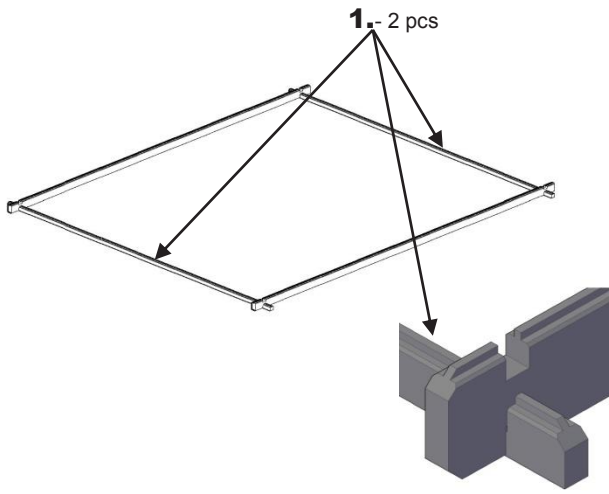

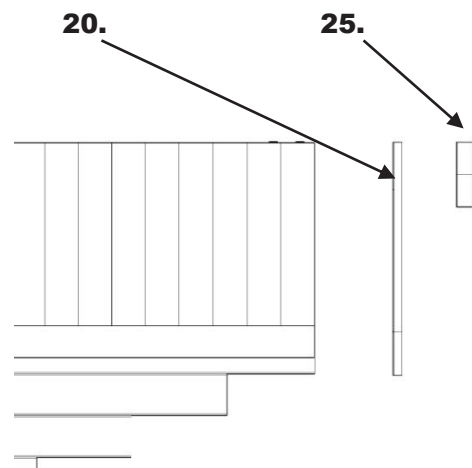
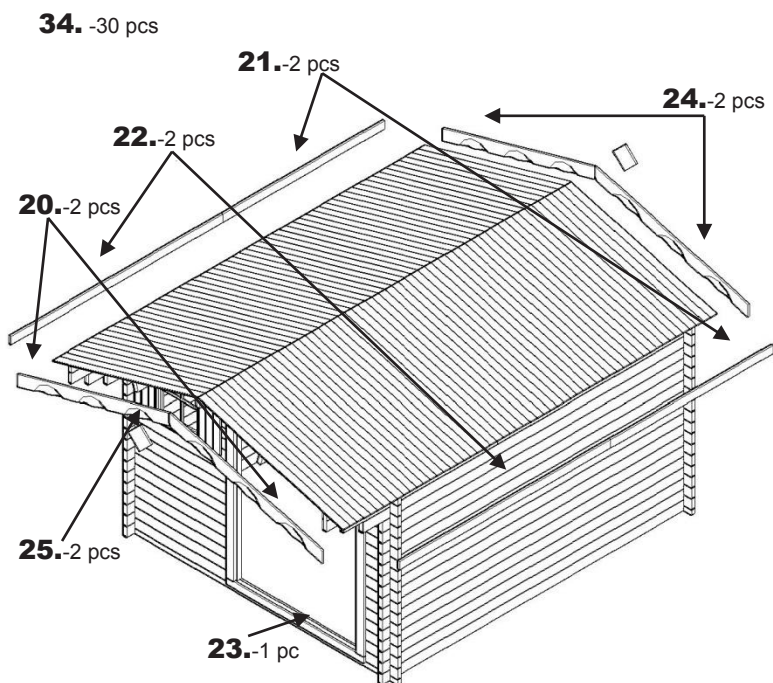

38.- 350 pcs

