

# Turmdrehkran

Tower Crane / Grue à tour / Gru a torre / Grúa torre /  
Guindaste de torre / Башенный поворотный кран

# 542 HC-L 18/36 Litronic®

542 HC-L 12/24 Litronic®

▶ 542 HC-L 18/36 Litronic®

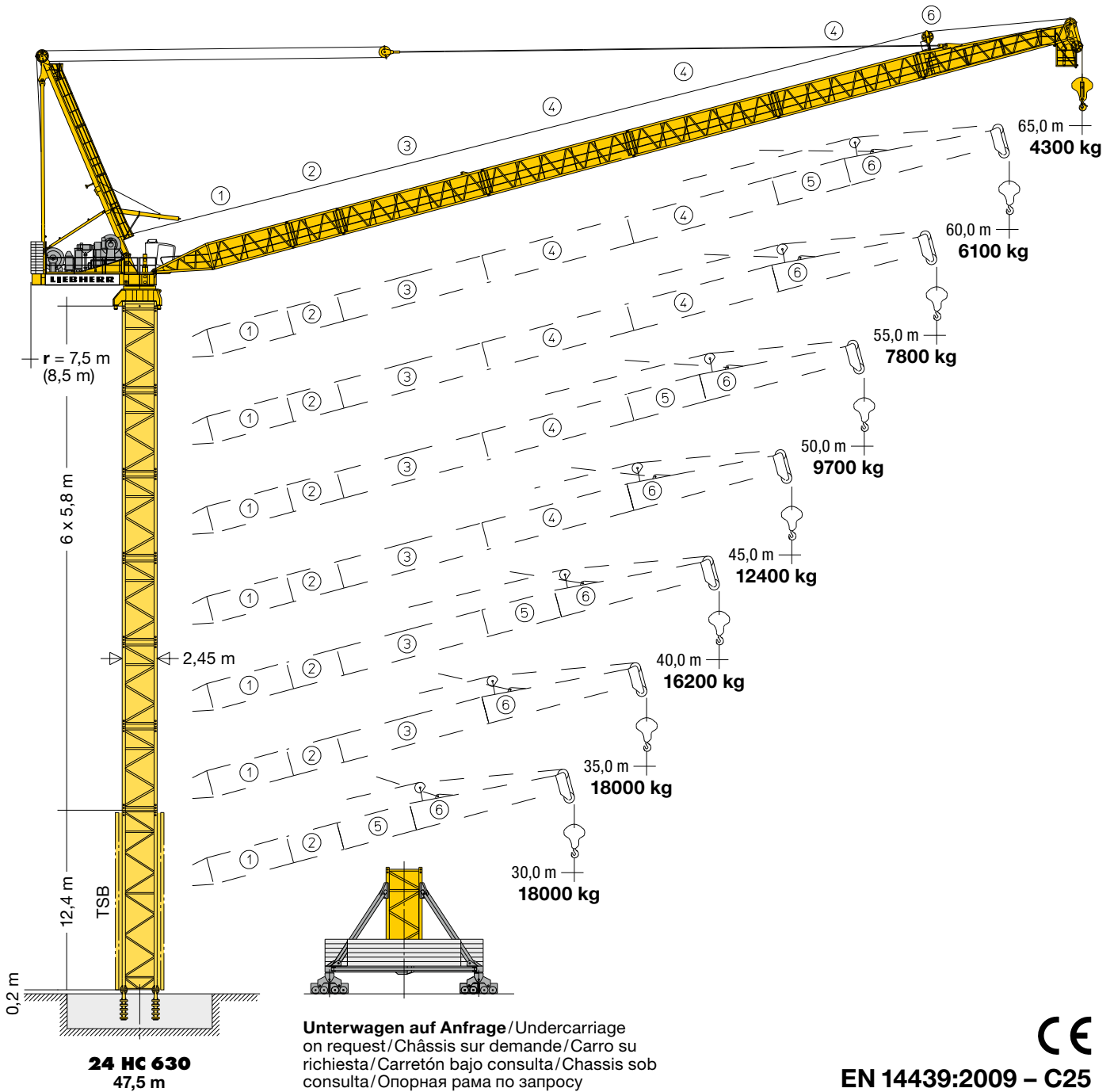

EN 14439:2009 – C25

# LIEBHERR

# Ausladung und Hubhöhe

Radius and hoisting height / Portée et hauteur de levage / Sbraccio e altezza di sollevamento / Alcance y altura de elevación / Alcance e altura de elevação / Вылет и Высота подъема

## Minimum Ausladung außer Betrieb

Minimum radius out of operation  
Portée minimum hors service  
Sbraccio minimo fuori servizio  
Alcance mínimo fuera de servicio  
Alcance mínimo fora de operação  
Минимальный вылет вне работы

Ausleger (m) Jib/Flèche/ Braccio/Pluma/ Lança/Стрела	Außenbetriebsstellung (α°) Out-of-operation position Position hors service Posizione fuori servizio Posición externa de la empresa Posição fora de operação Положение вне работы		
24 HC 630	α	↓ (m)	↷ (m)
65	76°	18,7	-
60	75°	18,5	18,0
55	74°	18,0	17,5
50	73°	17,4	16,9
45	72°	16,7	16,2
40	71°	15,7	15,2
35	70°	14,6	14,1
30	65°	15,1	14,6

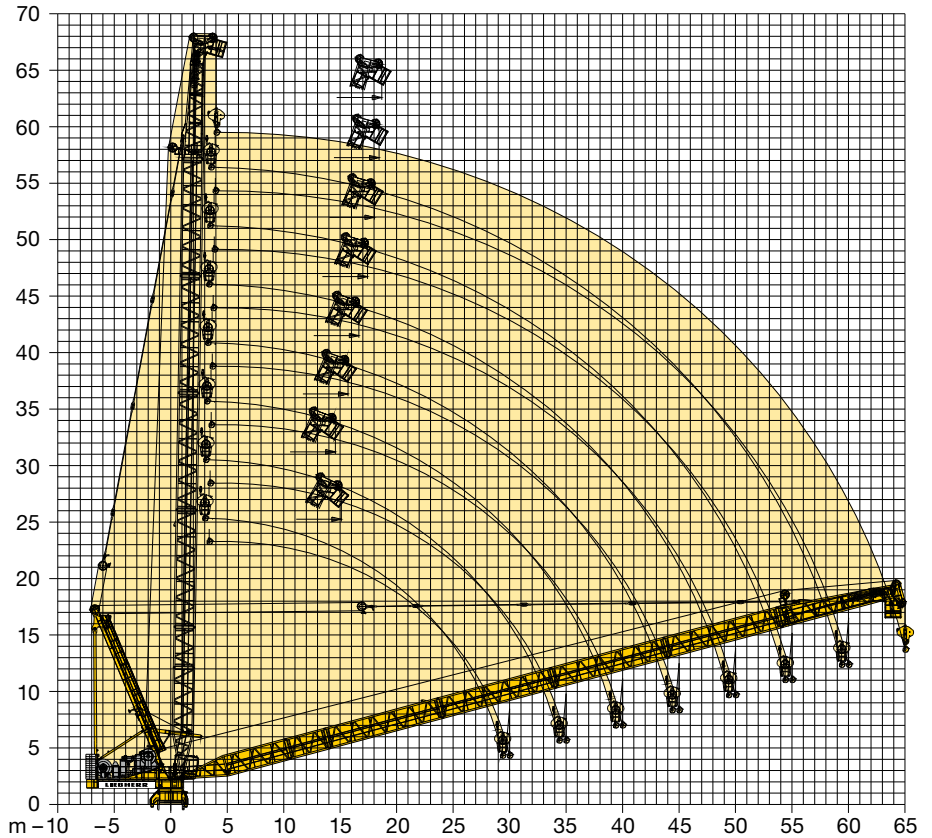

# Turmhöhen

Tower heights / Hauteur de mât / Altezza torre / Alturas de torre / Alturas de torre / Высота башни

24 HC 630									
Ausleger / Jib / Flèche / Braccio / Pluma / Lança / Стрела									
	30,0 m	35,0 m	45,0 m	60,0 m	30,0 m	35,0 m / 40,0 m	55,0 m	65,0 m	
		40,0 m	50,0 m	65,0 m		45,0 m / 50,0 m	60,0 m		
10	58,4 <sup>1)</sup>	-	-	-	-	-	-	-	-
9	52,6	52,6 <sup>1)</sup>	-	-	64,8 <sup>1)</sup>	-	-	-	-
8	46,8	46,8	46,8 <sup>1)</sup>	-	59,0	59,0 <sup>1)</sup>	-	-	-
7	41,0	41,0	41,0	41,0 <sup>1)</sup>	53,2	53,2	53,2 <sup>1)</sup>	-	-
6	35,2	35,2	35,2	35,2	47,4	47,4	47,4	47,4 <sup>1)</sup>	47,4 <sup>1)</sup>
5	29,4	29,4	29,4	29,4	41,6	41,6	41,6	41,6	41,6
4	23,6	23,6	23,6	23,6	35,8	35,8	35,8	35,8	35,8
3	17,8	17,8	17,8	17,8	30,0	30,0	30,0	30,0	30,0
2	12,0	12,0	12,0	12,0	24,2	24,2	24,2	24,2	24,2
1	6,2	6,2	6,2	6,2	18,4	18,4	18,4	18,4	18,4
0	0,4	0,4	0,4	0,4	12,6	12,6	12,6	12,6	12,6
	m				m				
	<p>24 HC 630 FA</p>				<p>24 HC 630 FA r</p>				



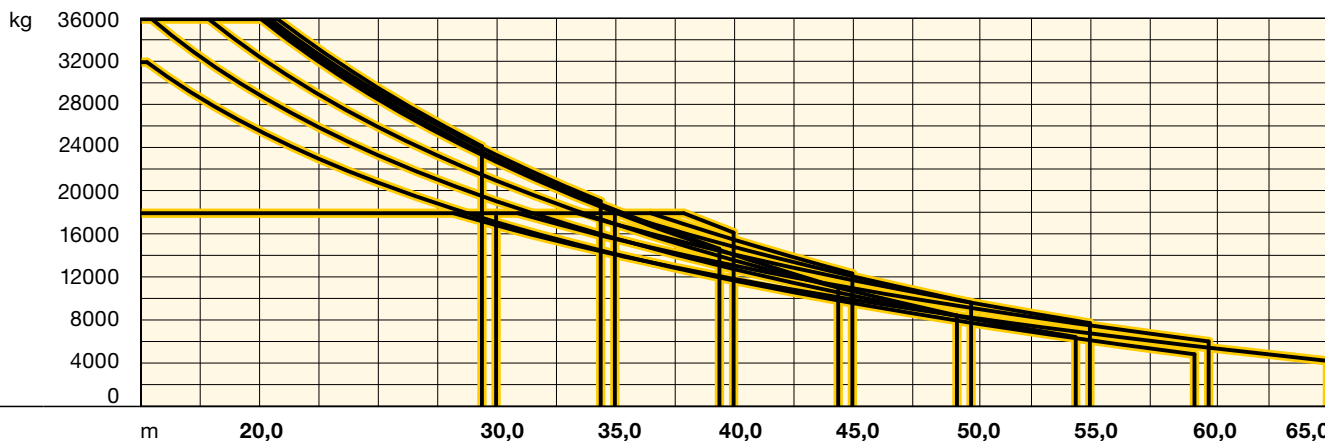

m	m/kg	m/kg																			
		17,5	20,0	22,5	25,0	27,5	30,0	32,5	35,0	37,5	40,0	42,5	45,0	47,5	50,0	52,5	55,0	57,5	60,0	62,5	65,0
65,0	4,1 – 28,2 18000	18000	18000	18000	18000	18000	16870	15450	14150	12980	11900	10910	9980	9120	8310	7560	6840	6160	5510	4900	4300
60,0	4,0 – 30,9 18000	18000	18000	18000	18000	18000	18000	17020	15600	14320	13140	12050	11030	10090	9200	8370	7580	6830	6100		
	3,6 – 15,3 32000	28740	25660	23070	20840	18900	17160	15620	14210	12930	11750	10670	9650	8710	7820	7000	6200	54,4 m 4900			
55,0	3,9 – 33,4 18000	18000	18000	18000	18000	18000	18000	18000	16990	15530	14180	12940	11780	10710	9690	8730	7800				
	3,8 – 15,5 36000	32580	29000	25990	23390	21130	19110	17300	15660	14170	12800	11530	10350	9250	8200	54,4 m 6500					
50,0	3,8 – 35,1 18000	18000	18000	18000	18000	18000	18000	18000	18000	16410	14870	13460	12140	10900	9700						
	3,4 – 17,9 36000	36000	32550	29040	26010	23370	21010	18910	16990	15250	13640	12150	10760	49,4 m 8500							
45,0	3,7 – 36,5 18000	18000	18000	18000	18000	18000	18000	18000	18000	17270	15540	13940	12400								
	3,3 – 20,1 36000	36000	36000	32090	28570	25490	22750	20300	18060	16030	14140	44,4 m 11100									
40,0	3,6 – 37,9 18000	18000	18000	18000	18000	18000	18000	18000	18000	18000	16200										
	3,2 – 20,3 36000	36000	36000	32430	28890	25790	23030	20560	18290	39,4 m 14700											
35,0	3,5 – 35,0 18000	18000	18000	18000	18000	18000	18000	18000	18000	18000	18000										
	3,2 – 20,5 36000	36000	36000	32790	29270	26180	23410	34,4 m 19100													
30,0	3,5 – 30,0 18000	18000	18000	18000	18000	18000	18000	18000	18000												
	3,0 – 20,8 36000	36000	36000	33250	29650	29,4 m 24200															



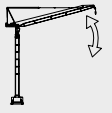
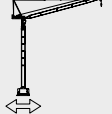

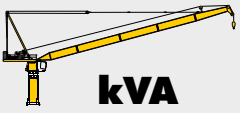
**Tragfähigkeiten gültig bis 100 m Hubhöhe. Über 100 m Hubhöhe reduziert sich die Tragfähigkeit um das zusätzliche Seilgewicht.** / Lifting capacities valid up to 100 m hoisting height. Over 100 m hoisting height, the lifting capacity is reduced by the additional rope weight. / Capacités de levage valables jusqu'à 100 m de hauteur sous crochet. Au-dessus de 100 m de hauteur sous crochet, la capacité de levage est réduite du poids de câble supplémentaire. / Portate valide fino a 100 d'altezza di sollevamento. Oltre i 100 m si riduce la portata causa il peso addizionale della fune. / Cargas válidas hasta altura de 100 m. Por encima de los 100 m se reduce la carga por el peso adicional del cable. / Cargas válidas ate à altura de 100 m. Para alem dos 100 m, reduz-se a carga pelo peso adicional do cabo. / Грузоподъемность действительна до 100 м высоты подъема. Свыше 100 м высоты подъема грузоподъемность сокращается на вес дополнительного каната.

	U/min 0 ↔ 0,6 sl./min tr./min	2 x 11 kW FU
	1,8 min	110 kW FU
	<b>Unterwagen auf Anfrage / Undercarriage on request / Chassis sur demande / Carro su richiesta / Carretón bajo consulta / Chassis sob consulta / Опорная рама по запросу</b>	



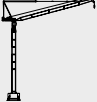
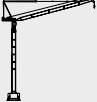

		110 kW FU	160 kW FU
		110 kW FU 221,0	110 kW FU 275,0

**kVA**

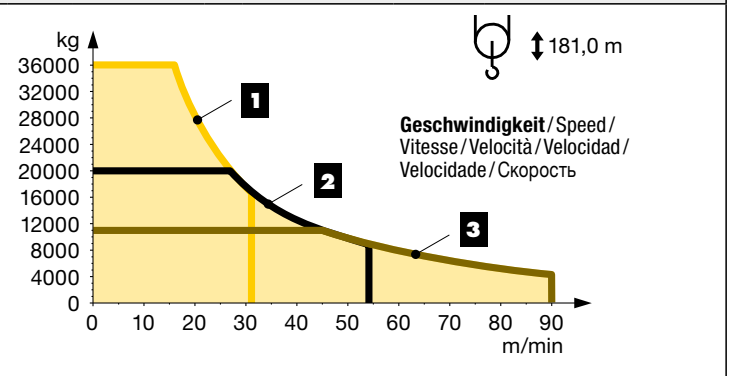
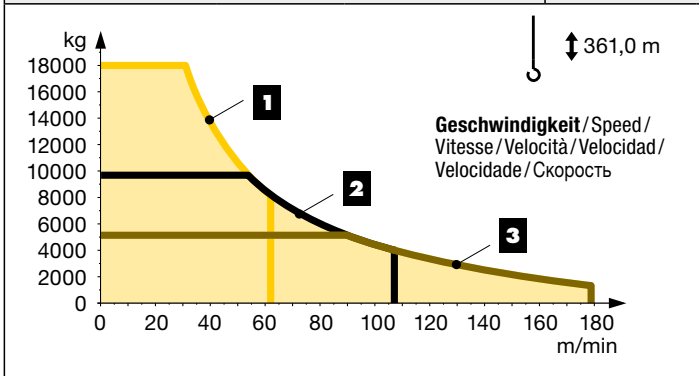
**kVA reduzierbar bei zu geringer Netz-Anschlussleistung, siehe BAL. /**  
 kVA can be reduced in case of too little power of the mains, see instruction manual. /  
 kVA peut être réduit en cas de trop faible puissance du réseau, voir manuel d'instruction. /  
 kVA riducibili in caso di potenza di rete ridotta (si veda manuale uso e manutenzione) /  
 kVA variable para potencia de red demasiado pequeña, ver Manual de instrucciones. /  
 kVA reduzível no caso de capacidade da rede elétrica muito baixa, ver manual de instruções. /  
 Количество кВА может быть сокращено до минимальной общей потребляемой мощности, см. инструкцию по эксплуатации.

		max. 1101 m	↔ <b>stufenlos / stepless / régl. continu / regl. progressiva / sin escalones / sem degraus / бесступенчатый</b>			
110 kW FU WIW 300 VZ 418	<b>4 Lagen / Layers / Couches / Avvolgimenti / Camadas / Capas / Слоёв</b>		kg	m/min	kg	m/min
			<b>1</b>	18000 0 ↔ 31	<b>1</b>	36000 0 ↔ 16
				8100 0 ↔ 62		16700 0 ↔ 31
			<b>2</b>	9700 0 ↔ 54	<b>2</b>	20000 0 ↔ 27
				3900 0 ↔ 107		8700 0 ↔ 54
			<b>3</b>	5100 0 ↔ 90	<b>3</b>	11000 0 ↔ 45
				1250 0 ↔ 179		4200 0 ↔ 90



		max. 1101 m	↔ <b>stufenlos / stepless / régl. continu / regl. progressiva / sin escalones / sem degraus / бесступенчатый</b>			
160 kW FU WIW 320 VZ 401	<b>4 Lagen / Layers / Couches / Avvolgimenti / Camadas / Capas / Слоёв</b>		kg	m/min	kg	m/min
			<b>1</b>	18000 0 ↔ 44	<b>1</b>	36000 0 ↔ 22
				10500 0 ↔ 73		21000 0 ↔ 37
			<b>2</b>	10700 0 ↔ 72	<b>2</b>	22000 0 ↔ 36
				5800 0 ↔ 119		12000 0 ↔ 60
			<b>3</b>	5300 0 ↔ 128	<b>3</b>	11000 0 ↔ 64
				2200 0 ↔ 213		5700 0 ↔ 107

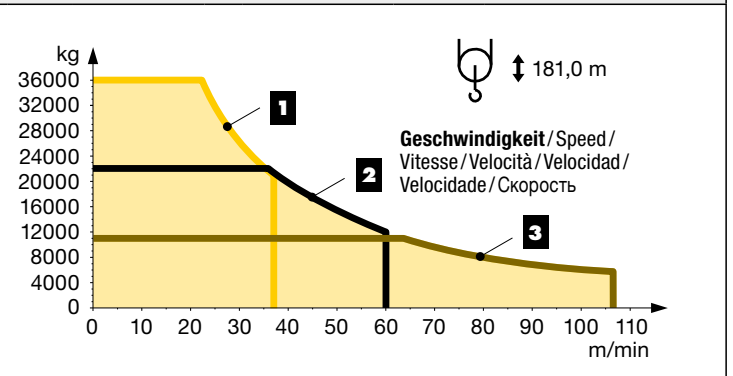
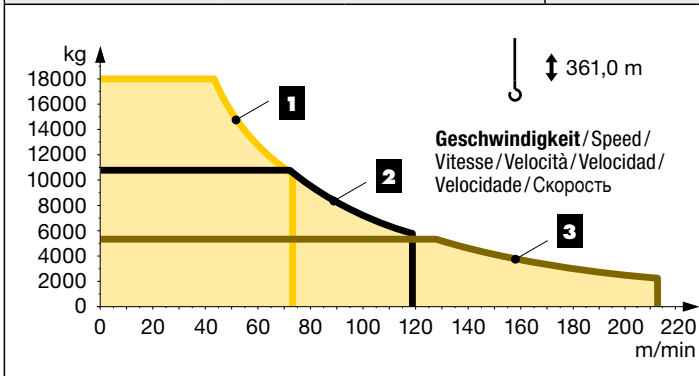



























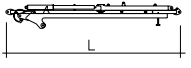

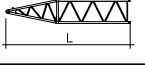



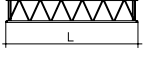

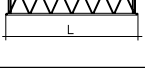



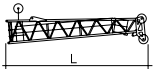









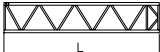



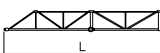



		<b>24 HC 630</b>							
		Ausleger / Jib / Flèche / Braccio / Pluma / Lança / Стрела							
n	h	30,0 m	35,0 m	45,0 m / 50,0 m	60,0 m	30,0 m	35,0 m	45,0 m / 50,0 m	60,0 m
			40,0 m	55,0 m	65,0 m		40,0 m	55,0 m	65,0 m
8		58,4	-	-	-	58,0	-	-	-
7		52,6	52,6	-	-	52,2	52,2	-	-
6		46,8	46,8	46,8	-	46,4	46,4	46,4	-
5		41,0	41,0	41,0	41,0	40,6	40,6	40,6	40,6
4		35,2	35,2	35,2	35,2	34,8	34,8	34,8	34,8
3		29,4	29,4	29,4	29,4	29,0	29,0	29,0	29,0
2		23,6	23,6	23,6	23,6	23,2	23,2	23,2	23,2
1		17,8	17,8	17,8	17,8	17,4	17,4	17,4	17,4
0	m	12,0	12,0	12,0	12,0	11,6	11,6	11,6	11,6

24 HC 630 FA

<sup>1)</sup> **Min. Verankerungshöhe kann bei max. Turmhöhe bzw. bei Hakenhöhe > 100 m abweichen.** / Min. anchoring height may deviate at max. tower height resp. hook height > 100 m. / La hauteur d'ancrage min. peut différer en cas de hauteur de mât max. resp. en cas de hauteur sous crochet > 100 m. / In caso dell'altezza max torre gancio, l'altezza min. di ancoraggio può differire di > 100 m. / La altura mínima de arriostamiento puede variar con una altura máxima de torre, es decir para alturas bajo gancho > 100 m. / Em uma torre, com uma altura do gancho > 100 m a altura mín. do ancoramento pode variar. / Мин. высота крепления к зданию может изменяться при макс. высоте башни или при высоте крюка более 100 м.

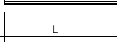
<b>Kranoberteil</b>		<b>Upper part of crane / Partie supérieure de grue / Parte superiore della gru / Parte superior grúa / Parte superior do guindaste / Верхняя часть крана</b>	<b>L (m)</b>	<b>B (m)</b>	<b>H (m)</b>	<b>kg<sup>2)</sup></b>		
Pos. Anz. Item Qty. Rep. Qte. Voce Qta. Pos. Cant. Ref. Cant. Поз. Кол-во								
1a	1	<b>Drehkranz-Auflage / Slewing ring support / Pivot / Ralla / Corona de giro / Cremalheira / Рама поворотного круга</b>			2,74	2,50	2,27	5800
1b	2	<b>Konsole / Bracket / Console / Supporto / Soporte / Suporte / Консоль</b>			1,34	0,88	0,33	360
1c	2	<b>Konsole / Bracket / Console / Supporto / Soporte / Suporte / Консоль</b>			1,33	0,64	0,34	290
2	1	<b>Drehbühne mit Rollendrehkranz / Slewing platform with slewing ring / Plate-forme tournante avec roulement / Piattaforma girevole con ralla / Plataforma de giro con asiento de pista / Plataforma giratoria com suporte de cremalheira / Поворотная платформа с роликовым поворотным кругом</b>			3,00	2,25	2,53	10800
3	1	<b>Getriebebühne / Gear platform / Plate-forme des mécanismes / Piattaforma meccanismi / Plataforma de mecanismos / Лебёточная платформа</b>			6,75	2,22	2,53	9100
4	1	<b>Hubwerk 110 kW / Hoist gear / Mécanisme de levage / Argano di sollevamento / Mecanismo de elevación / Mecanismo de elevação / Механизм подъёма</b>			3,90	2,28	2,00	6500
5	1	<b>Einziewerk 110 kW / Luffing gear / Mécanisme de relevage / Argano sollevamento braccio / Mecanismo de elevación pluma / Mecanismo de elevação da lança / Стрелоподъёмный механизм</b>			3,10	2,32	1,60	4900
6	1	<b>Fahrerhauspodest mit Kabine / Driver's cabin with platform / Cabine de grutier avec plate-forme / Pedana gruista con cabina / Plataforma con cabina / Plataforma com cabina / Площадка с кабиной</b>			6,00	2,20	2,57	2000
7	3	<b>Seitenpodest / Side platform / Plate-forme latérale / Pedana laterale / Plataforma lateral / Plataforma lateral / Боковая площадка</b>			6,50	1,20	1,00	400
8	1	<b>Auslegerhaltebock, geteilt / Jib retaining frame, split / Chevalet de retenue de flèche, en éléments / Cavalletto tirante braccio, diviso / Caballete de soporte de pluma, dividido / Cavalete de suporte da lança, dividido / Кронштейн стрелы, составной</b>			12,01	2,28	2,56	10100
9	1	<b>Ausleger-Anlenkstück / Jib heel section / Pied de flèche / Sezione articolata braccio / Pluma tramo prime- ro / Base articulada de lança / Корневая секция стрелы</b>			10,00	1,96	1,90	① 3000
10	1	<b>Ausleger-Zwischenstück 3,6 m / Intermediate jib section / Élément intermédiaire de flèche / Sezione intermedia braccio / Tramo intermedio pluma / Peça suplementar da lança / Промежуточная секция стрелы</b>			3,85	1,90	1,90	② 1050
11	1	<b>Ausleger-Zwischenstück 10,36 m (Festpunkt) / Intermediate jib section (fixed point) / Élément inter- médiaire de flèche (point fixe) / Sezione intermedia braccio (punto fisso) / Tramo intermedio pluma (punto fijo) / Tramo intermedio da lança (ponto fixo) / Проме- жуточная секция стрелы (Фиксированная точка)</b>			10,60	1,90	2,10	③ 2600
12	3	<b>Ausleger-Zwischenstück 10,36 m / Intermediate jib section / Élément intermédiaire de flèche / Sezione inter- media braccio / Tramo intermedio pluma / Peça suple- mentar da lança / Промежуточная секция стрелы</b>			10,60	1,90	1,90	④ 2300
13	1	<b>Ausleger-Zwischenstück 5,18 m (Festpunkt) / Intermediate jib section (fixed point) / Élément intermé- diaire de flèche (point fixe) / Sezione intermedia braccio (punto fisso) / Tramo intermedio pluma (punto fijo) / Tramo intermedio da lança (ponto fixo) / Промежуточ- ная секция стрелы (Фиксированная точка)</b>			5,50	1,90	2,10	⑤ 1250
14	1	<b>Ausleger-Kopfstück / Jib head section / Pointe de flèche / Punta braccio / Tramo punta de pluma / Cabeça de lança / Концевая секция стрелы</b>			11,50	2,00	2,55	⑥ 4400
15	1	<b>Unterflasche / Bottom hook block / Moufle inférieure / Bozzello inferiore / Polipasto inferior / Gincho inferior / Крюковая обойма</b>			2,45	1,45	0,80	1700

Pos. Item Rep. Voce Pos. Ref. Поз.	Anz. Qty. Qte. Qta. Cant. Cant. Кол-во				L (m)	B (m)	H (m)	kg <sup>2)</sup>	
16	1	<b>Einzelseilflasche</b> / Luffing rope pulley block / Tambour de relevage / Bozzello di sollevamento braccio / Polipasto cable de retracci3n / Gincho de cabo de retra3a3o / Замок стрелового каната			1,50	1,20	1,10	600	
17	1	<b>Hilfskran mit Lagerungen</b> / Auxiliary crane with supports / Grue auxiliaire avec logements / Gru auxiliaria con supporti / Grúa auxiliar con apoyos / Grua auxiliar com apoios / Вспомогательный кран			4,40	0,90	0,60	700	
<b>Turm</b> Tower / Mât / Torre / Torre / Torre / Башня									
18	1	<b>Grundturmstück</b> / Base tower section / Mât de base / Elemento di torre base / Tramo base / Peça de base de torre / Секция основания			24 HC 630 TSB-1242c	12,42	2,68	2,68	14461
19	1	<b>Turmstück</b> / Tower section / Élément de mât / Elemento di torre / Tramo torre / Torre / Башенная секция			24 HC 630 TS-0580c	6,28	2,45	2,45	6480
<b>Klettern am Gebäude</b> Climbing on the building / Télésco-page à l'extérieur du bâtiment / Telescopaggio esterno all'edificio / Trepado exterior a edificio / Telescopagem exterior ao edificio / Нарращивание высоты крана, пристыгнутого к зданию									
20	2	<b>Führungsstück-Hälfte mit Podesten</b> / Guide section with platform / Cage télescopique avec plate-formes / Sezione guida con pedane / Tramo guia con plataforma / Tramo guia com plataforma / Половина направляющей секции с площадками				12,60	2,95	1,75	3950
21	1	<b>Hydraulikanlage und Klettereinrichtung</b> / Hydraulic unit and climbing equipment / Système hydraulique et équipement de télésco-page / Impianto idraulico e dispositivo di telescopaggio / Sistema hidráulico y equipo de trepado / Sistema hidraulico e telescopagem / Гидроагрегат и обойма наращивания							3100
<b>Klettern im Gebäude</b> Climbing in the building / Télésco-page dans le bâtiment / Pure varianti di gru allungabili / Subida no edificio / Trepado dentro del edificio / Самоподъем крана в здании									
22	1	<b>Kletterturmstück (D-St.)</b> / Climbing tower section / Élément de hissage de mât / Elemento torre di telesco-paggio / Tramo de torre trepador / Tramo de telesco-pagem / Секция самоподъема			380 IC 24 HC 630 - D1	6,28 6,30	1,90 2,45	2,81 2,45	9300 9600
	1				24 HC 630 - D2	6,30	2,45	2,45	9400
23	1	<b>Hydraulikanlage und Klettertraverse</b> / Hydraulic unit and climbing cross members / Système hydraulique avec traverses de télésco-page / Impianto idraulico e traverse di allungamento / Equipo hidráulico y traviesa de trepado / Equipamento hidraulico e travessa de telescopagem / Гидроагрегат и траверса наращивания			355/380 IC 24 HC 630	2,50 -	0,80 -	0,60 -	1500 3150
24	1	<b>Einspannturmstück (B)</b> / Anchoring tower section / Élément de mât d'encastrement / Elemento torre d'ancoraggio / Tramo de torre inferior de trepado / Tramo de telescopagem inferior / Упорная секция			355 IC 24 HC 630	6,28 6,30	1,90 2,45	1,90 2,45	6600 9300
25	6	<b>Führungsrahmen (Hälfte)</b> / Guide frame (half) / Cadre de hissage (moitié) / Telaio guida (metà) / Bastidor guía (mitad) / Bastidor de guia (metade) / Направляющая рама (половина)			355/380 IC 24 HC 630	3,55 3,05	0,78 0,95	0,48 0,65	2500 1700
26	1	<b>Kletterleiter</b> / Climbing ladder / Echelle de télésco-page / Scala di telescopaggio / Escalera de trepar / Régua para telescopagem / Лестница самоподъема			355/380 IC 24 HC 630	5,10 5,70	0,40 0,45	0,10 0,15	490 530
<b>Ballast</b> Ballast / Lest / Zavorra / Lastre / Lastro / Балласт									
27	11	<b>Stahlballast</b> / Steel ballast / Lest en acier / Contrappeso di acciaio / Lastres metálicos / Lastro metálico / Металлический балласт				4,50	0,90	0,20	4910
<b>Kleinteile</b> Small parts / Accessoires / Accessori / Accesorios / Acessórios / Мелкие детали									
28	1	<b>Seile, Kleinteile</b> / Ropes, small parts / Câbles, accessoires / Funi, accessori / Cables, accesorios / Cabos, acessórios / Канаты, мелкие детали						4500	

<sup>2)</sup> Einzelgewichte / Single weights / Poids individuels / Singoli pesi / Tramo punta de pluma / Pesos de peças componentes / Индивидуальный вес

**Änderungen vorbehalten!** / Subject to technical modifications! /  
Sous réserves de modifications ! / Con riserva di modifiche! /  
¡Sujeto a modificaciones sin previo aviso! / Sujeto a modificacões! /  
С правом внесения изменений!

**Sämtliche Angaben erfolgen ohne Gewähr.** / This information is supplied without liability. /  
Ces renseignements sont sans garantie. / Tutte le indicazioni fornite senza garanzia. /  
Declinamos toda responsabilidad derivada de la información proporcionada. / Declinamos  
qualquer responsabilidade quanto à informação fornecida. / Все данные указаны без обязательств.

**TCS-001050-LBC-01 • EN 14439:2009 – A3 • BGL C.0.11.0500 • 04.19**

Printed in Germany.

Liebherr-Werk Biberach GmbH  
Postfach 1663, D-88396 Biberach an der Riss  
☎ +49 73 51 41-0, Fax: +49 73 51 41 22 25  
www.liebherr.com, E-Mail: info.lbc@liebherr.com

Liebherr Industrias Metálicas, S.A.  
Polígono Industrial Agustinos, calle E, E-31014 Pamplona  
☎ +34 94829 70-00, Fax +34 94829 70-29  
www.liebherr.com, E-Mail: info.lim@liebherr.com