

BR-1225A

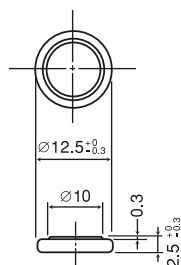

SPECIFICATIONS

Name	BR-1225A
Nominal voltage (V)	3
Nominal capacity (mAh)	48
Continuous drain (mA)	0.03
Operating temperature (°C)	-40 to +125
Weight (g)	0.8

DISCHARGE TEMPERATURE CHARACTERISTICS

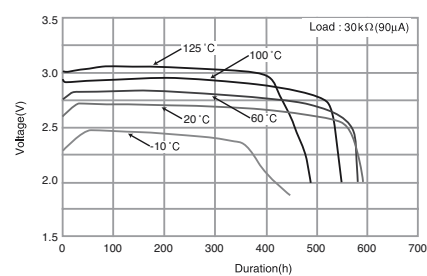

BR-1632A

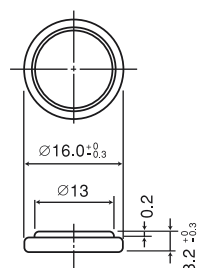

SPECIFICATIONS

Name	BR-1632A
Nominal voltage (V)	3
Nominal capacity (mAh)	120
Continuous drain (mA)	0.03
Operating temperature (°C)	-40 to +125
Weight (g)	1.5

DISCHARGE TEMPERATURE CHARACTERISTICS

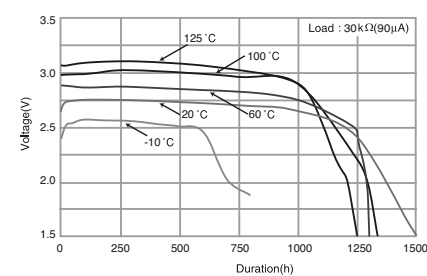

BR-2330A

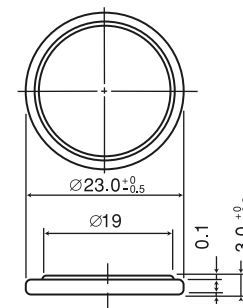

SPECIFICATIONS

Name	BR-2330A
Nominal voltage (V)	3
Nominal capacity (mAh)	255
Continuous drain (mA)	0.03
Operating temperature (°C)	-40 to +125
Weight (g)	3.2

DISCHARGE TEMPERATURE CHARACTERISTICS

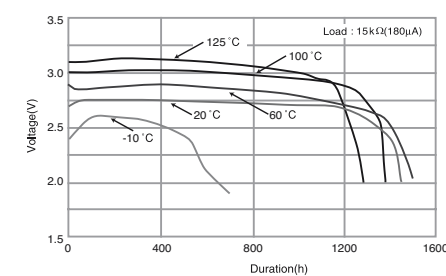

BR-2450A

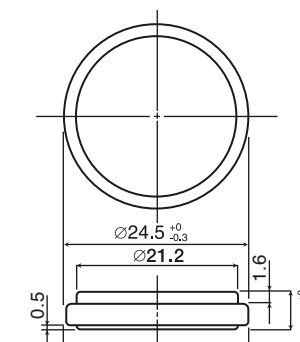

SPECIFICATIONS

Name	BR-2450A
Nominal voltage (V)	3
Nominal capacity (mAh)	550
Continuous drain (mA)	0.03
Operating temperature (°C)	-40 to +125
Weight (g)	5.9

DISCHARGE TEMPERATURE CHARACTERISTICS

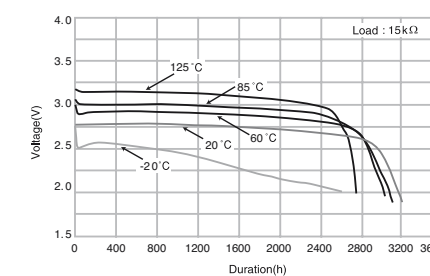

2 HIGH TEMPERATURE POLY-CARBONMONOFLUORIDE LITHIUM BATTERIES

BR-2477A

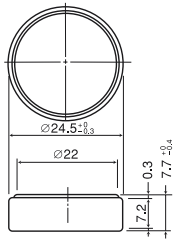

SPECIFICATIONS

Name	BR-2477A
Nominal voltage (V)	3
Nominal capacity (mAh)	1,000
Continuous drain (mA)	0.03
Operating temperature (°C)	-40 to +125
Weight (g)	8.0

DISCHARGE TEMPERATURE CHARACTERISTICS

