

Spot light source

LIGHTNINGCURE[®] SERIES

Lamp warranty: Guarantees a long operating life of 4000 hours

LC8

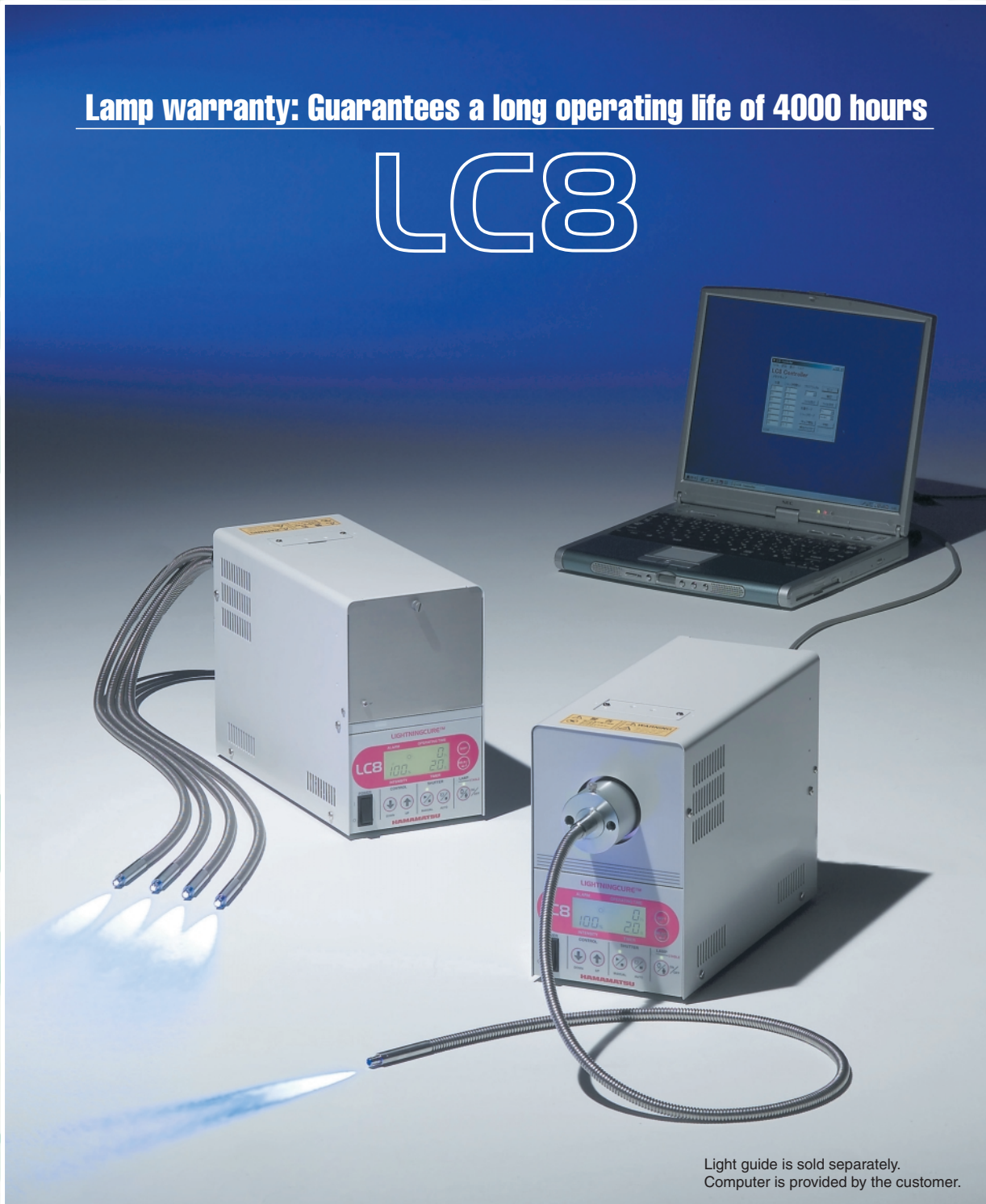

Light guide is sold separately.
Computer is provided by the customer.

Two new functions for making photocuring simple and reliable!

1 Operate it from your PC via the RS-232C port.



This unit has a built-in RS-232C port to allow PC or micro-computer control that was impossible up until now. Making program entries (irradiation intensity, irradiation time) for the Memory Step is now accurate and easy. You can operate the light source even in a location where direct access to it is impossible.

Using the USB adaptor connector lets you use a PC even if it has no RS-232C port. We also offer sample software that displays easy-to-use setup screens, etc.

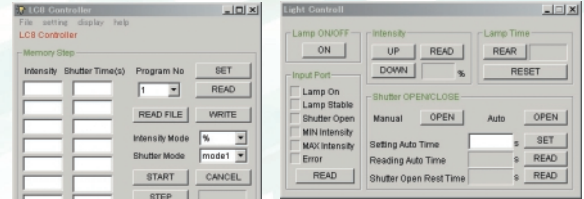

Memory Step setting dialogue

Light source control dialogue

When PC starts communication

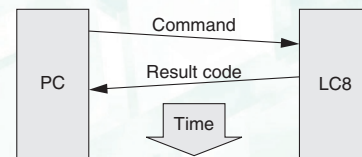

Communication is started by PC and finished by the result code sent from the unit.

2 Light intensity monitor with internal optical feedback function

(Option: Sold separately)



This unit maintains the light intensity at a fixed level for stable irradiation. Light intensity usually varies over time during lamp operation. Our light source, however, can constantly maintain the preset light intensity since it regulates light intensity while monitoring it with an internal sensor.

This spot light source also has internal light feedback and so does not need a dedicated feedback light guide used in conventional products.

The irradiation intensity (reference value) is displayed as a digital value (in watts) on the LCD display. This eliminates problems that occur due to human error and different operating conditions. Full control even of detailed settings makes it ideal for fully automated production lines.



Display screen showing W (watts units)

Feature Memory Step™ for 9 types 7-step programs



Program the irradiation intensity and irradiation time to any level you want! Freely set the UV irradiation conditions to match the component you want to bond.

The LIGHTNINGCURE LC8 lets you store 9 types of 7-step programs in the memory, so optimal irradiation conditions matching the component for bonding can be set just by changing the program number. This holds true even when multiple bonding components are flowing in the same production process or when shifting to different production lines.

The LC8 is especially ideal for components that must be fixed in place with high precision. The mounting positions of these components often deviate due to stress warping and contraction in the adhesive that causes positional shifts. Using the LC8 gives better production stability and higher product yield especially for components demanding high position precision.

Program example 1: Increasing light irradiance in 7 steps

Shutter "open" between steps

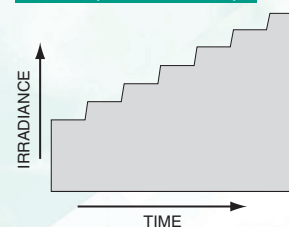

Shutter "closed" between steps

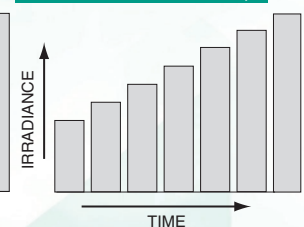

Program example 2: Random irradiance and irradiation time settings

Shutter "open" between steps

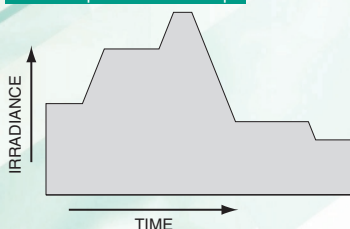

Shutter "closed" between steps

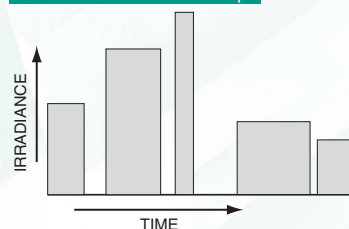

Program example 3: Low irradiance and then long-term high intensity

Shutter "open" between steps

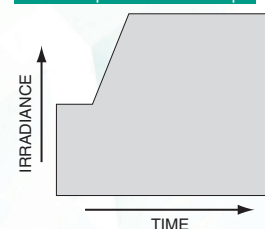

Shutter "closed" between steps

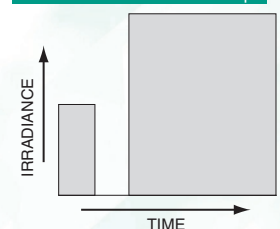

LIGHTNINGCURE LC8

"Easy Maintenance" "Great Energy Saving"

FEATURES & FUNCTIONS

Long service life

Guaranteed service life: 4000 h (-01A type and -02A type)

UV intensity generally declines with lamp operating time. Hamamatsu has drastically improved these drops in light output by using a mercury-xenon lamp whose electrodes suffer almost no wear and an improved optical system.

●Variations in UV output [365 nm] over time (typical values)

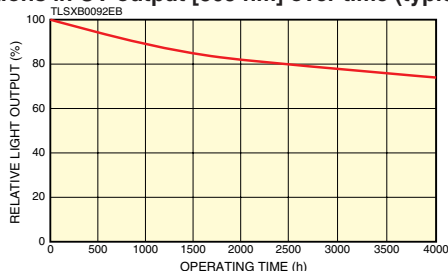

Anybody can use it! One-touch replacement!

Lamp is replaceable in less than 30 seconds!

Just insert the lamp to replace it. No wiring to worry about. This is so easy you can do it with one hand.

Lamp is the cassette type with a preset optical axis so no troublesome optical alignment is needed after replacement.



Full line-up of external control equipment

(RS-232C and D-sub connector: standard feature, terminal block: option E9795-01 [sold separately])

You can turn the lamp on and off and control the shutter externally. An alarm signal output is also available. Signals and data can be exchanged with the PC via the RS-232C.

This unit will prove ideal for production environments such as semi-automated or fully au-



Upper: D-SUB connector
Under: RS-232C

Clever layout allows a compact body

Superb features are concentrated into a compact body. Weight has been reduced to a mere 6.4 kg. Area of installation can be reduced.

Stacking the units allows saving even more space.

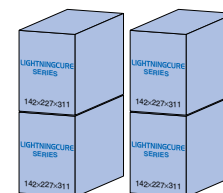

Unit: mm

Great energy saving benefits

Our 200 W lamps have high output equal to lamps in the 250 W class. Light sources using our 200 W lamps also have less power consumption than those using 250 W lamps. Power consumption is the lowest in its class (280 VA Typ.). This means using multiple UV light source units at production facilities will yield tremendous energy saving benefits.

Instantaneous power-outage response program

Restores operation in about 10 seconds after power outages of a second or less. Conventional products take at least a few minutes to start up again after a power shutdown, so you can see this function drastically shrinks downtime due to power outages.

This function is especially convenient in places where the supply of power is intermittent or unstable.

Power supply compatible in world-wide

Internal power supply automatically switches to a 100 V or 200 V input. There is no problem when shifting the operating location in world-wide.



CE marking compliance

The LIGHTNINGCURE complies with CE marking requirements and can also be used in Europe.

Meets the following standards

· Safety standards: IEC 61010-1 · EMC standards: IEC 61326-1 Group 1, Class A

Selectable positions of light guide port

A front port type and a rear port type are available. The front port type allows lamp replacement from the operation panel side. This helps hold limits on equipment movement and installation location to a minimum. Select the light guide port position that best matches the component for bonding and its mounting position.



Left: Rear light guide port type L9566, Right: Front light guide port type L9588

Irradiance adjustable anywhere within 0 to 100 %!

An electric diaphragm mechanism allows a digital display of the relative light output from 0 % to 100 % on the LCD panel. Unlike conventional analog scales, this means highly precise light irradiation. Light output also can be controlled from an external device, so meeting various kinds of measurement conditions is now even easier.

Light output vs. panel display

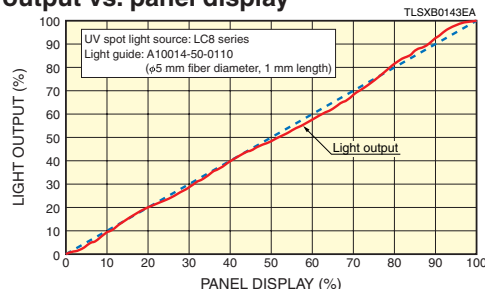

"Long Life" "High Output"

STRUCTURE

Easy filter replacement

Eight types of filters are provided for selecting the irradiation light. A single screwdriver is all you need to replace the filter via the upper filter insertion port. There is no need to open any cover as on conventional units, so you save even more replacement time.

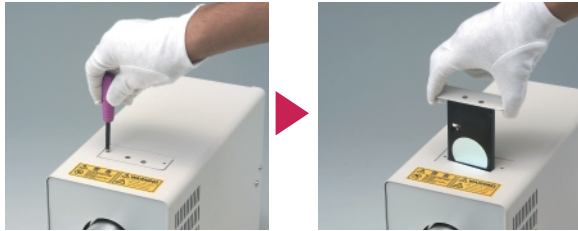

Filters and filter holder are sold separately.

High efficiency optical system - no heat problems

The LC8 combines a mercury-xenon lamp having high output UV line spectra with an elliptical reflector having reflectivity higher than 90 % in the UV range and a quartz light guide with excellent UV transmittance.

The lamp can be operated in a horizontal position, so the optical system has less light loss compared to lamps operated in an upright position, allowing the UV light to input efficiently to the light guide. The elliptical reflector efficiently reflects only the UV light, and lets heat rays and visible light pass through to prevent adverse effects from heat on the irradiated point (-01A type and -02A type).

●Structural View

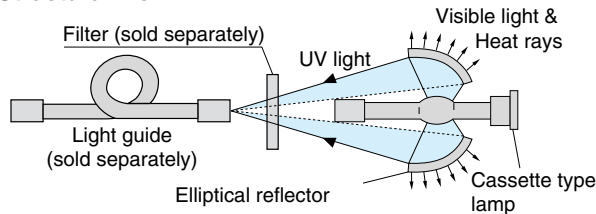

TLSXC0040EC

No optical axis alignment

Uses a highly stable mercury-xenon lamp developed expressly for analysis and measurement applications. There is almost no wear on the electrodes and no positional shift of the arc point. Absolutely no optical axis alignment is needed, even during lamp replacement or during lamp use.

●Electrode wear

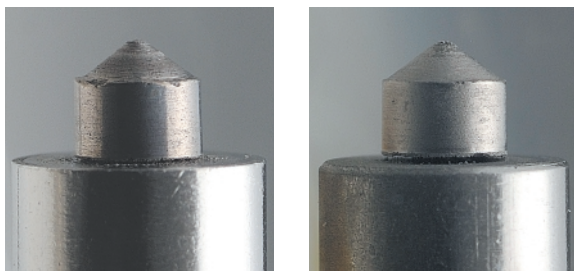

Before use

After 4000 hours of use

CHARACTERISTICS

Selectable wavelength

The LC8 allows you to select the wavelength range you need. The lineup includes the model "-01A" with a center wavelength of 365 nm, "-02A" enhanced for 250 nm wavelength band, "-03" designed for the visible light range, "-04" of total reflection type, and "-06" with a wide band around 365 nm. Select the light source that matches your applications.

If you need special specifications, please feel free to consult us.

●UV spectral distribution (-01A type, -02A type and -06A type)

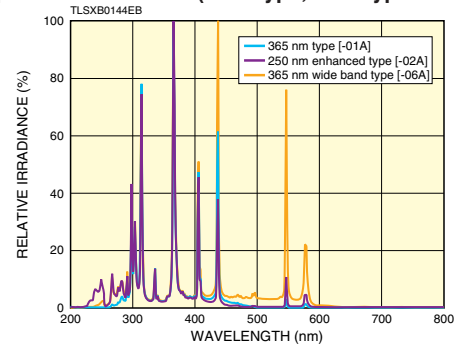

●Visible light spectral distribution (-03 type and -04 type)

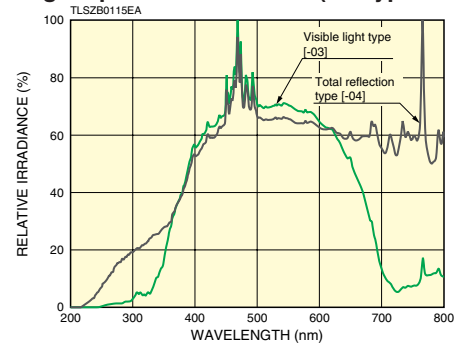

Visible light and the infrared rays can be cut, and it can combine with the filter etc. that suppress the heat influence on the irradiation part to the minimum (see "ACCESSORY" section).

High output

UV irradiance: 4500 mW/cm² (-01A type, at 365 nm)

The LC8 yields an extremely strong spectral distribution in the UV range most effective for UV curing. UV irradiance distribution is dependent on the distance from the light guide output end to the target surface to be irradiated, as well as on the type of light guide used. The greater the distance from the light guide output end to the target surface, the more the maximum UV irradiance drops and the more the light beam expands (see below).

●UV intensity distribution

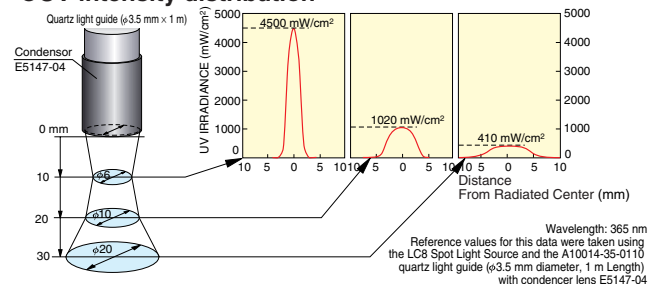

Reference values for this data were taken using the LC8 Spot Light Source and the A10014-35-0110 quartz light guide (φ3.5 mm diameter, 1 m Length) with condenser lens E5147-04

TLSXB0145EB

CONTROL

Control	Front panel control	Communication connector (RS-232C)	External control terminal (D-SUB connector) *1
Main Power ON/OFF	○	—	—
Lamp ON/OFF	○	○	○
Shutter Drive	Open/Close	○	○
	Auto Open/Close by Timer *2	○	○
	Auto Shutter Time Setting	○	—
Irradiation Program (Memory Step™) Setting	○	○	—
Optical Power Adjustment (UP/DOWN)	○	○	○
Lamp ON Indicator	○	○ (Signal Output)	○ (Signal Output)
Lamp Stability Indicator	○	○ (Signal Output)	○ (Signal Output)
Shutter Open Indicator	○	○ (Signal Output)	○ (Signal Output)
Lamp Operation Hour Meter	○	○	—
Overheat Alarm	○	○ (Signal Output)	○ (Signal Output)
Lamp Operation Time Alarm	○	○ (Signal Output)	○ (Signal Output)
Operating Switch for Power Saving Mode *3	—	—	—

*1 10P terminal block is available as option E9795-01 (sold separately).

○ : available, — : not available

*2 Corresponds to "start/stop" of Memory Step™.

*3 The operating switch is inside

SELECTION GUIDE

Type No.	Radiant wavelength range ①		Lamp for maintenance ②	Guaranteed life
L9566-01A / L9588-01A	[365 nm type]	300 nm to 450 nm	L10852	4000 h (at 365 nm)
L9566-02A / L9588-02A	[250 nm band enhanced type]	240 nm to 400 nm	L10852	4000 h (at 365 nm)
L9566-03 / L9588-03	[Visible light type]	400 nm to 700 nm	L8253	2000 h (at 436 nm)
L9566-04 / L9588-04	[Total reflection type]	300 nm to 800 nm	L8253	2000 h (at 436 nm)
L9566-06A / L9588-06A	[365 nm wide band type]	240 nm to 550 nm	L10852	4000 h (at 365 nm)

NOTE: ① Major radiant wavelengths. Various optical filters (sold separately) can also be attached. Refer to the radiant spectral distribution graph for details on the spectral distribution.

② L10852 is 200 W super-quiet mercury-xenon lamp. L8253 is 150 W super-quiet xenon lamp with ozone-free bulb.

SPECIFICATIONS

Parameter	L9566	L9588
Light Guide Port	Rear	Operation panel (front)
Lamp Replacement Position	Operation panel (front)	Rear
UV Intensity (Typ.) [Ⓐ]	4500 mW/cm ² Typ. (at 365 nm, -01A type)	
Radiant Wavelength Range	Refer to the SELECTION GUIDE	
Lamp for Maintenance	Refer to the SELECTION GUIDE	
Lamp Service Life	Refer to the SELECTION GUIDE	
Power Supply Input	100 V ac to 240 V ac (100 V / 200 V auto switching), single phase 47 Hz to 63 Hz	
Power Consumption	280 VA Typ.	
Weight	Approx. 6.4 kg	
Operating Ambient Temperature	+5 °C to +35 °C	
Storage Ambient Temperature	-10 °C to +70 °C	
Operating and Storage Humidity	Less than 80 % (no condensation)	

NOTE: [Ⓐ] UV irradiance (at 365 nm) is measured in the center at a point 10 mm away from the output end of the A10014-35-0110 light guide (sold separately) with E5147-04, by using the Hamamatsu C6080-13 UV power meter.

Optical Power Monitor with Optical Feedback E9793-02

Parameter	Description / Value
Monitoring Wavelength	365 nm [Ⓑ]
Applicable Type	(L9566, L9588) -01A, -02A [Ⓒ]

NOTE: [Ⓑ] Monitoring at other wavelengths is not possible.

[Ⓒ] When optical power monitor order with L9566 and L9588, please tell us the type No. whether (L9566, L9588)-01A-02 or (L9566, L9588)-02A-02.

DIMENSIONAL OUTLINES

L9566

(Unit: mm)

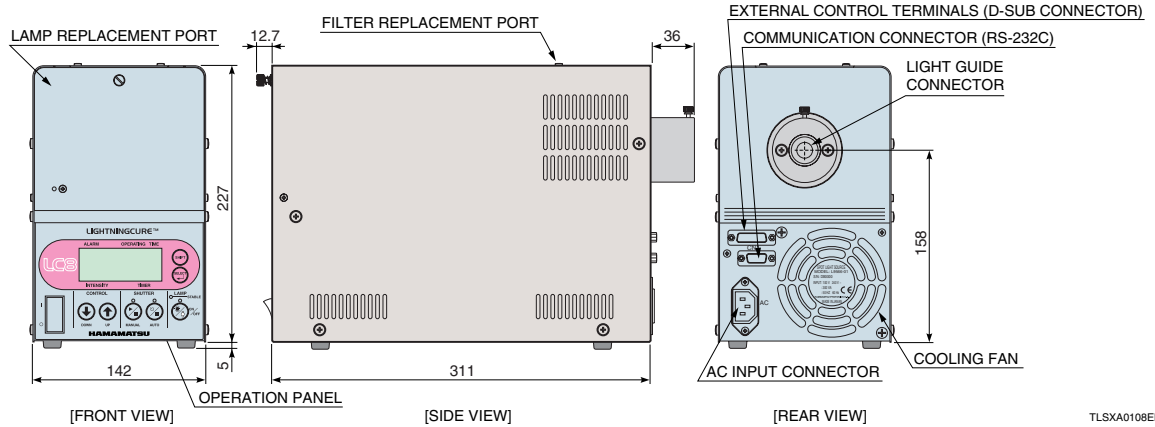

TLSXA0108ED

L9588

(Unit: mm)

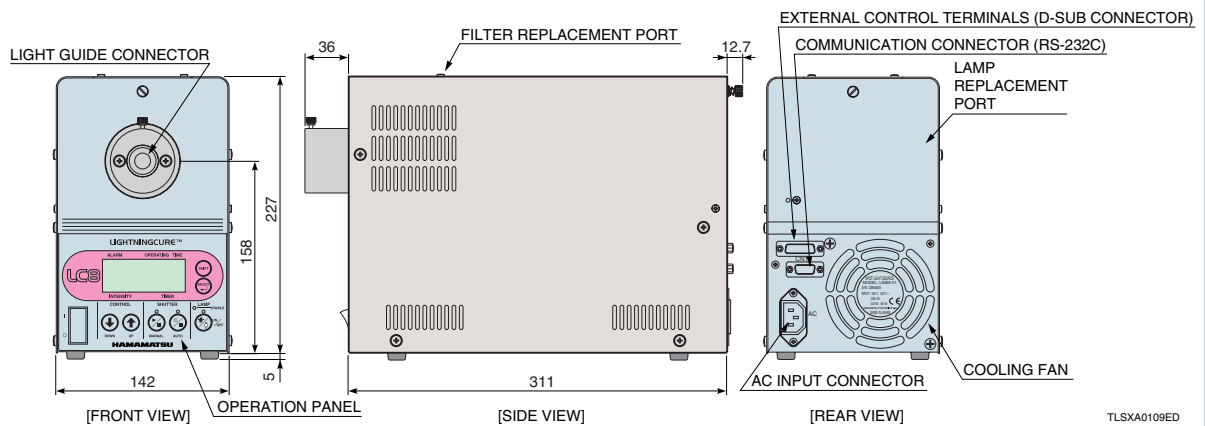

TLSXA0109ED

⚠ WARNING

● Light

This equipment emits very strong ultraviolet light which is harmful to eyes and the skin.

Also, as the light emanating from the light guide connection aperture contains infrared light in addition to ultraviolet light, its irradiation will cause heat generation. Be sure to observe following instructions for operation of the equipment.

- Never look directly into the light guide connection aperture or at the light emanating from the light guide. Strong ultraviolet light can cause visual disorder.
- Do not allow light to come into contact with skin. Contact with skin may cause sunburn-grade inflammation. Always wear safety glasses, gloves, and other appropriate protective gear when operating this equipment.
- Never allow light from the light guide to radiate onto flammable material.
- The unit includes an interlock that prevents the lamp from lighting while top cover is open. Never attempt to override the interlock function by manually depressing the switch, as this may result in uncontrolled release of dangerous ultraviolet light.

● High-Voltage trigger

- The mercury-xenon lamp employed started by a high-voltage (30 kV) pulse applied at the lamp electrodes.

As protection against accidental electrical shock hazard, the design includes an interlock switch that disables lamp operation while the top cover is open. Never attempt to turn on the lamp by blocking the sensor window of the interlock switch.

● Lamp Replacement

- The inside of the lamp housing becomes extremely hot during lamp operation. Before replacing the lamp, switch it off and run the cooling fan for at least 15 minutes.
- Always exercise due caution when handling or replacing a lamp.

A lamp contains high-pressure gas [approximately 1 MPa (10 atmospheres) at room temperature, approximately 4 MPa (40 atmospheres) during operation] and may burst if dropped or otherwise impacted.

● Inhibition of Removal and Modification

- Do not remove the cover unless absolutely necessary and never touch any of the screws inside the unit. As the internal components of this unit have been precisely adjusted, disassembling or modifying the equipment can cause problems with the unit, fire and electrical shock.

DISPOSAL OF LAMPS

Lamps are filled with high pressure (approx. 1 MPa at room temperature) xenon gas (xenon gas and mercury in mercury-xenon lamps). When disposing of the used lamp, take appropriate measures in compliance with applicable regulations regarding waste disposal and correctly dispose of it yourself, or entrust disposal to a licensed industrial waste disposal company. In any case, be sure to comply with the regulations in your country, state, region or province to ensure the used lamp is disposed of legally and correctly.

WARRANTY PERIOD

This device is guaranteed for one year after delivery date from us. The warranty extends only to replacement of the products. The warranty does not cover damage due to misuse or natural calamity.

LIGHTNINGCURE LC8 ACCESSORY

LIGHT GUIDES

Various light guides using a core material with high UV transmittance are available ranging from the single type up to a 6-furcated type. Select the desired light guide that suits your application. We also welcome requests for custom light guides with different numbers of furcated ends, output end shapes and lengths.

CUSTOM LIGHT GUIDE

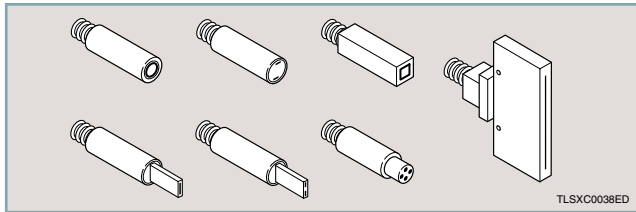

TLSXC0038ED

DIMENSIONAL OUTLINE OF OUTPUT END (UNIT: mm)

Ⓐ to Ⓔ: see the right table.

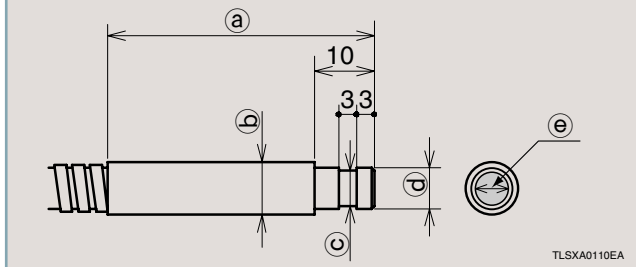

TLSXA0110EA

TYPE NO. GUIDE

A10014-35-0110

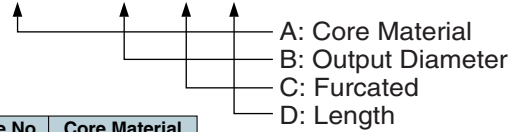

A

Type No.	Core Material
A10014	Synthetic silica
A10015	Glass

B (Suffix numbers are examples)

Suffix	Output Diameter
35	φ3.5 mm
50	φ5 mm
70	φ7 mm

C (Suffix numbers are examples)

Suffix	Furcated
01	Single
04	4
06	6

D (Suffix numbers are examples)

Suffix	Length
10	1 m
15	1.5 m
30	3 m

MAIN LIGHT GUIDE

Type No.				a	b	c	d	e
A	B	C	D					
A10014	35	01	10	45	φ8	φ5.8	φ6	φ3.5
A10014	35	02	10					
A10014	35	03	10					
A10014	35	04	10					
A10014	35	05	10					
A10014	35	06	10					
A10014	50	01	10	60	φ11	φ6.5	φ7	φ5
A10014	50	02	10					
A10014	50	03	10					
A10014	50	04	10					
A10014	70	01	10	60	φ14	φ8.5	φ9	φ7
A10015	50	01	10					

LIGHT BEAM DISTRIBUTION

Relative light irradiance: with 100% equal to the intensity at position 10 mm away from the output end without condensor lens when the LC8 L9566-01 is used with the A10014-50-0110.

* Z: Distance from output end

A10014-35-0110 (at 365 nm)

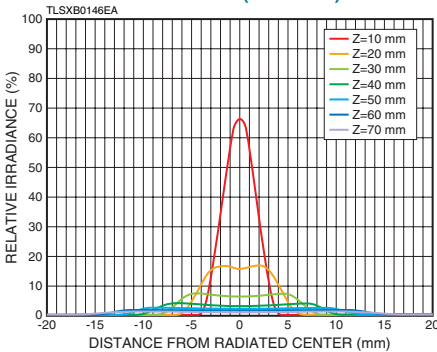

A10014-50-0110 (at 365 nm)

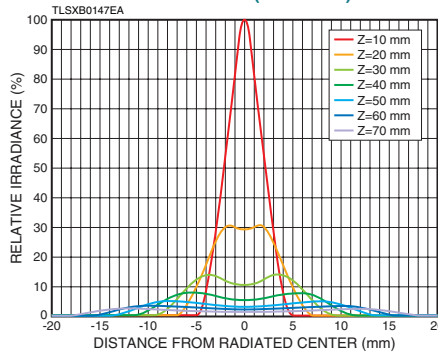

A10014-70-0110 (at 365 nm)

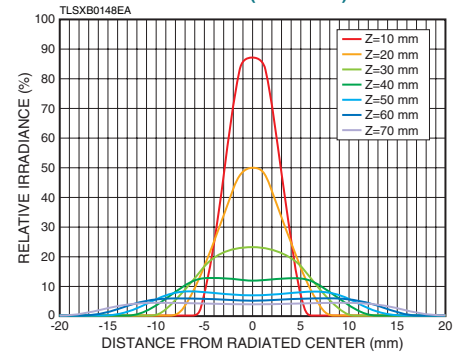

A10015-50-0110 (at 436 nm) *2

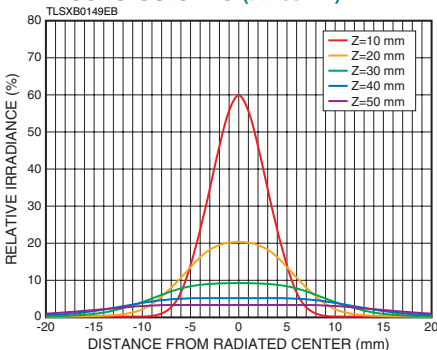

MAXIMUM INTENSITY FOR FURCATED FIBER

A10014-35 SERIES (Suffix, lower 4 digits)

Single (-0110)	2 furcated (-0210)	3 furcated (-0310)	4 furcated (-0410)	5 furcated (-0510)	6 furcated (-0610)
65 %	60 %	50 %	45 %	40 %	35 %

A10014-50 SERIES (Suffix, lower 4 digits)

Single (-0110)	2 furcated (-0210)	3 furcated (-0310)	4 furcated (-0410)
100 %	75 %	60 %	50 %

*2 Relative light irradiance: with 100% equal to the intensity at position 10 mm away from the output end when the LC8 L9566-01 is used with the A10014-50-0110. (436 nm)

ACCESSORY

CONDENSER LENSES

Condenser lenses collect light emitted from a light guide and make it illuminate an object efficiently.

DIMENSIONAL OUTLINE

LONG FOCAL POINT CONDENSER LENS E5147,-02

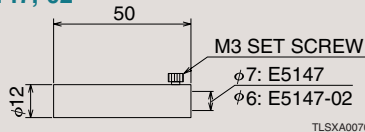

TLSXA0070EB

LONG FOCAL POINT CONDENSER LENS E7658-01,-02

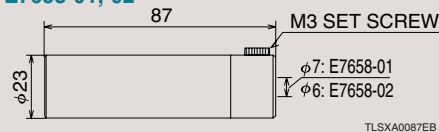

TLSXA0087EB

SHORT FOCAL POINT CONDENSER LENS E5147-03,-04

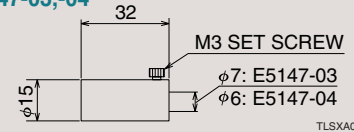

TLSXA0071EB

LIGHT BEAM DISTRIBUTION <Reference>

LONG FOCAL POINT CONDENSER LENS E5147 (Output Diameter: ϕ 5 mm)

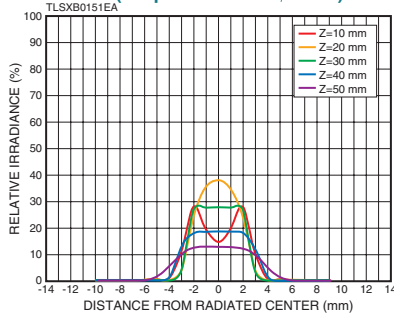

LONG FOCAL POINT CONDENSER LENS E7658-01 (Output Diameter: ϕ 5 mm)

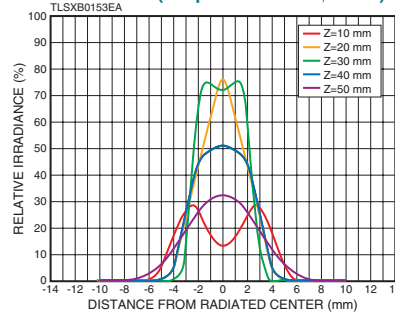

SHORT FOCAL POINT CONDENSER LENS E5147-03 (Output Diameter: ϕ 5 mm)

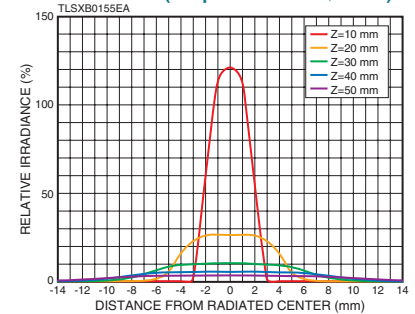

LONG FOCAL POINT CONDENSER LENS E5147-02 (Output Diameter: ϕ 3.5 mm)

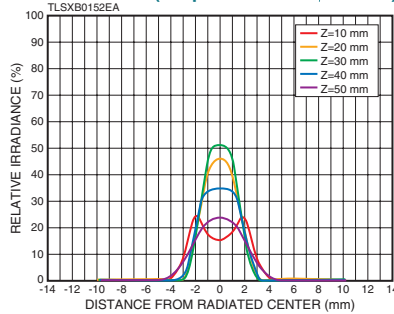

LONG FOCAL POINT CONDENSER LENS E7658-02 (Output Diameter: ϕ 3.5 mm)

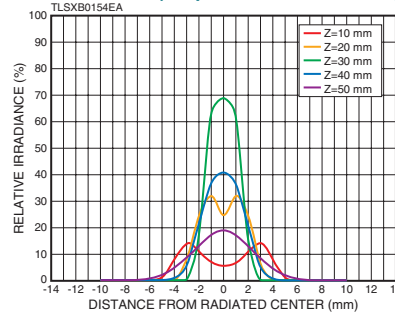

SHORT FOCAL POINT CONDENSER LENS E5147-04 (Output Diameter: ϕ 3.5 mm)

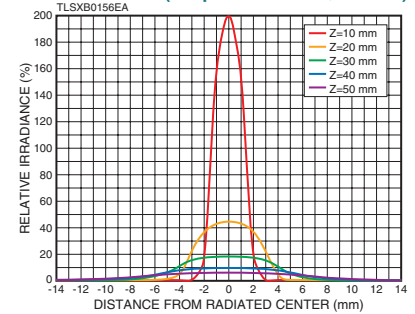

CONDENSER LENSES (Uniform illumination)

Hamamatsu also provides a special lens that uniformly illuminates an entire surface.

We offer a choice of lenses for uniformly irradiating an entire target area. We provide a condenser lens type that attaches to the tip of the light guide, and a uniform direct irradiation unit that attaches directly to the body of the spot light source.

This uniform direct irradiation unit allows uniform irradiation onto the target surface area with light intensity variations within about $\pm 5\%$. Three

different lens types are available according to the size of the irradiation surface area.

Efficiently emits light at wavelengths longer than 300 nm.

DIRECT BEAM UNIFORM ILLUMINATION UNIT UNIFORMITY

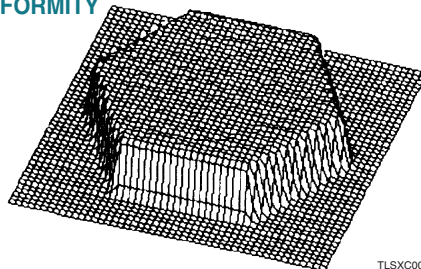

TLSXC0039EA

DIMENSIONAL OUTLINE (UNIT: mm)

DISTANCE FROM OUTPUT END E5147-06

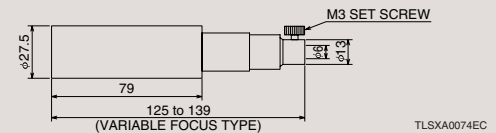

TLSXA0074EC

DIRECT BEAM UNIFORM ILLUMINATION UNIT

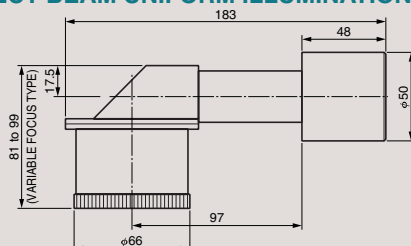

TLSXA0112ED

* The holder of the main body needs to be changed.
The exclusive light guide adaptor is necessary for the one of LC5 / LC6.

Condenser lenses are recommended when illuminating an object located away from the light guide end.

(UNIT: mm)

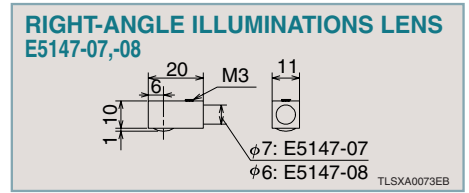
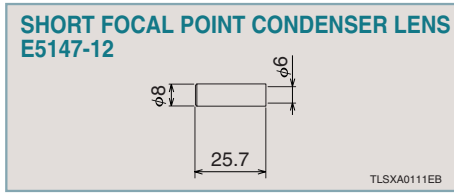
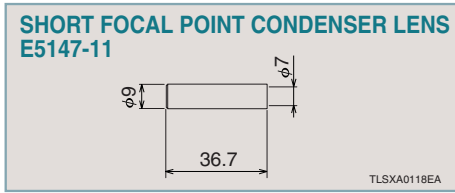

Relative light intensity: 100 % equal to the intensity at position 10 mm away from the output end without condenser lens * Z: Distance from output end

SHORT FOCAL POINT CONDENSER LENS E5147-11 (Output Diameter: ϕ 5 mm)

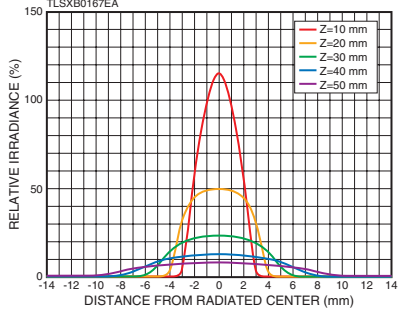

RIGHT-ANGLE ILLUMINATIONS LENS E5147-07 (Output Diameter: ϕ 5 mm)

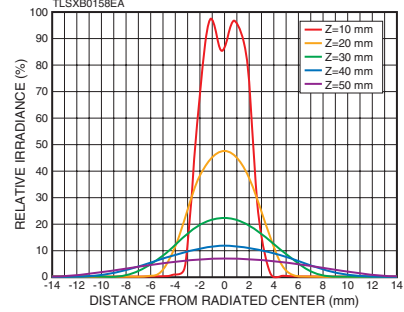

SHORT FOCAL POINT CONDENSER LENS E5147-12 (Output Diameter: ϕ 3.5 mm)

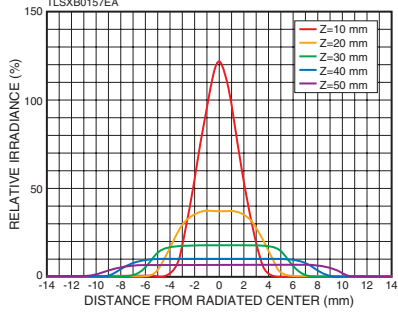

RIGHT-ANGLE ILLUMINATIONS LENS E5147-08 (Output Diameter: ϕ 3.5 mm)

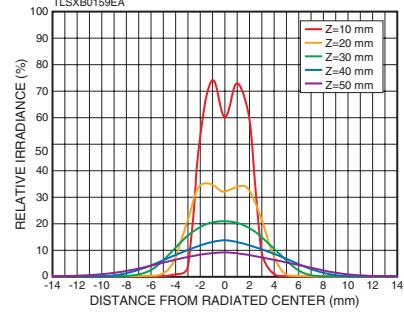

LIGHT BEAM DISTRIBUTION <Reference>

Relative irradiance: with 100 % equal to the intensity at position 10 mm away from the output end without condenser lens when the L9566 / L9568-01A is used with the A10014-50-0110.

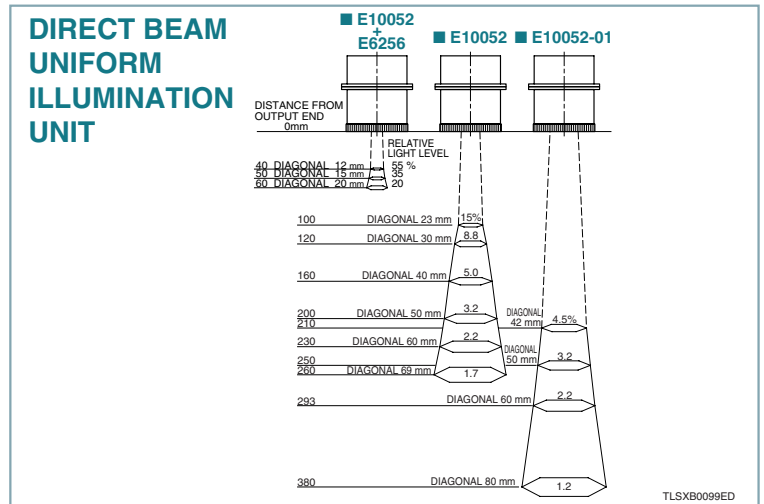
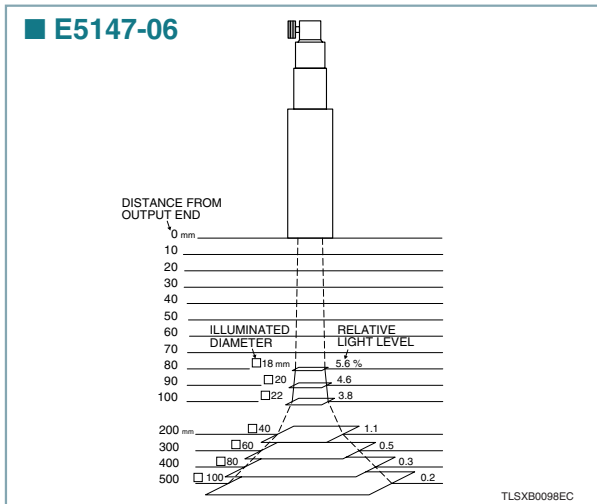

ACCESSORY

FILTERS

Eight types of filters are available, including UV-transmitting filters that efficiently transmit only the UV light needed for UV curing, as well as infrared cut filters and UV cut filters. Please select the filter that matches your applications. The types "-03" and "-05" are designed to minimize heat generation from the irradiated surface, making them effective when bonding components that are vulnerable to heat. These filters have a long service life. Almost no drop in the transmittance even after 10000 hours of operation.

SPECIFICATIONS

Type No.	Number of Filter Used	Transmittance Wavelength (nm)	Transmittance (%)	NOTE
A9616-03	1	280 to 400	Approx. 85	High UV transmittance, block heat
A9616-05	2	350 to 400	Approx. 80	Cuts off heat over a wide spectral range more efficiently than -03 type.
A9616-06	1	300 to 480	Approx. 85	Block visible to infrared light
A9616-07	2	355 to 375	Approx. 50	Transmissive light of around 365 nm only
A9616-08*	1	350 to 600	Approx. 85	Transmissive visible light and block infrared light
A9616-09	1	over 400	Approx. 95	Block UV light
A9616-10	2	300 to 400	Approx. 85	Block infrared light
A9616-11	2	230 to 250	Approx. 60	Transmissive light of around 248 nm only

* This is only available with light source -03.

RADIANT SPECTRUM CHARACTERISTICS WITH A FILTER ATTACHED

■ A9616-03 (Light Source: -01A)

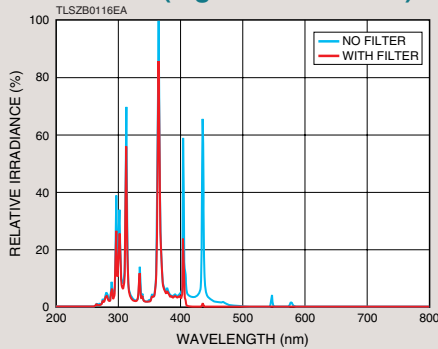

■ A9616-05 (Light Source: -01A)

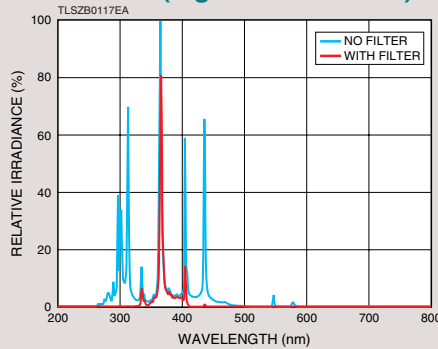

■ A9616-06 (Light Source: -06A)

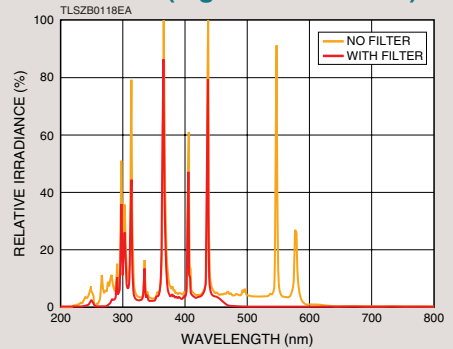

■ A9616-07 (Light Source: -01A)

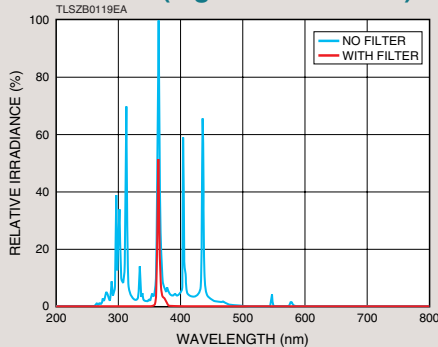

■ A9616-08 (Light Source: -03)*

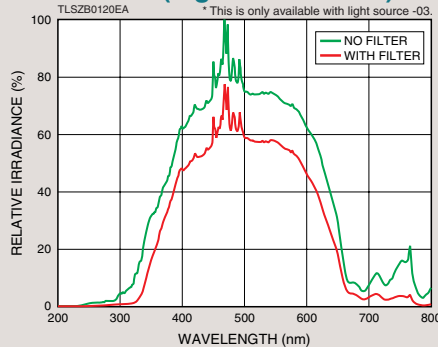

■ A9616-09 (Light Source: -03)

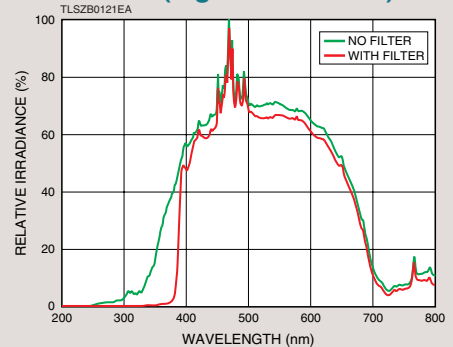

■ A9616-10 (Light Source: -01A)

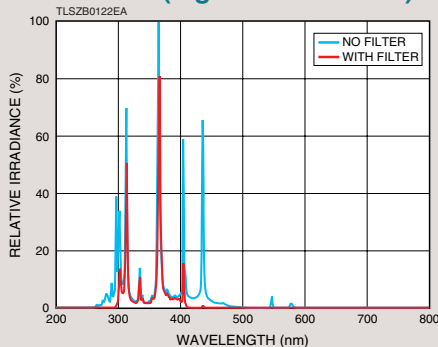

■ A9616-11 (Light Source: -02A)

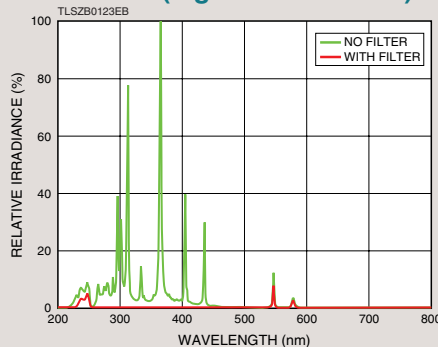

DIMENSIONAL OUTLINE

(UNIT: mm)

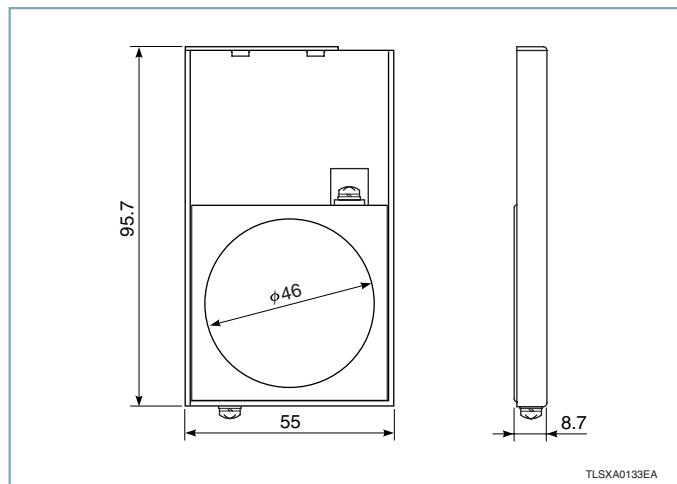

TEMPERATURE COMPARISON ON THE ILLUMINATED SURFACE

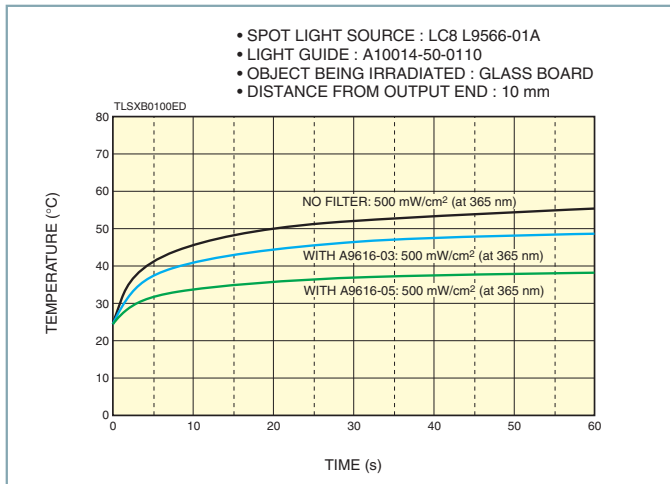

NOTE: The data shown above is typical values measured by Hamamatsu, just for your reference. Actual performance may greatly depend on the object to be illuminated and distance to it, and may differ from the above data.

UV POWER METER

C6080

This optical power meter is specifically designed to measure the intensity of ultraviolet light emitted from the spot light source.

The C6080 is a high-precision power meter. Calibrating it once a year is recommended.

Type No.	Sensitive Area (mm)	Calibrated Wavelength (nm)	Optical Power Measurement Range (mW/cm ²)
C6080-02	φ6	248	0 to 1999
C6080-365-03	φ1	365	
C6080-04	φ1	436	
C6080-365	φ1	365	0 to 19990



▲C6080

C9386 [LIGHT CHECKER]

The C9386 is ideal for making daily checks of irradiation intensity and its pocket-size makes it great for field work. The small sensor head is convenient for measuring narrow and hard to access locations.

Type No.	Sensitive Area (mm)	Calibrated Wavelength (nm)	Optical Power Measurement Range (mW/cm ²)
C9386	φ0.8	365	0 to 3999

* The calibration for C9386 should be done at customer side.

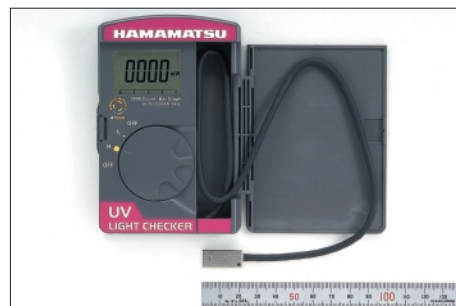

▲C9386

FOOT SWITCH

E8263 SERIES

Pushing on the E8263 foot switch opens and closes the shutter. These are highly effective when a worker is using 1 or more spot light sources.

Different product series are available according to the cable length, connection method and operating method you need.

Type No.	Cable Length	Connection	Operation
E8263-12	2 m	Terminal block	Manual shutter or auto shutter selectable
E8263-15	5 m		
E8263-22	2 m	D-SUB connector	Manual shutter
E8263-25	5 m		Auto shutter
E8263-32	2 m		
E8263-35	5 m		



LIGHT GUIDE CAP

A9739 SERIES

The A9739 is a light guide cap for protecting the exit end of a light guide from gas evaporating from adhesive and from dust and scratches.

The light-transmitting window fitted to the cap is easily exchangeable with a spare window (supplied) so there is no maintenance or cleaning down-time. Protecting the light guide end with an A9739 light guide cap eliminates shipping and repair costs required for re-polishing. Two types of light guide caps and replaceable windows are available according to the light guide bundle diameter.

PROTECTIVE CAP (supplied with one replacement window)

A9739-06: Light guide bundle diameter 3.5 mm

A9739-07: Light guide bundle diameter 5 mm

REPLACEMENT WINDOW (material: quartz)

A9740: For light guide bundle diameters 3.5 mm and 5 mm



PROTECTIVE GLASSES

A6905

Spot light sources emit invisible intense UV radiation which is harmful to the human eyes. Protective glasses or goggles must be worn during work.



RELATED PRODUCTS

UV-LED SPOT LIGHT SOURCE LC-L1V3

The LC-L1 V3 is a spot light source containing an ultraviolet LED (365 nm or 385 nm). It operates at low power consumption and helps reduce cost and environmental load.

By cutting wasted space to an absolute minimum we came up with a unit that drives 4 heads but is small enough to fit in the palm of your hand.



UV-LED UNIT LIGHTNINGCURE® LC-L5

The LC-L5 is an innovative linear irradiation type UV-LED unit. It allows to set up new production processes that were impossible up to now with conventional LED light source. The LC-L5 can already be found in the recent UV printing equipment and other production facilities. The product line-up includes a variety of types that allow to select an irradiation width and wavelength (365 nm or 385 nm) to match the work-piece.

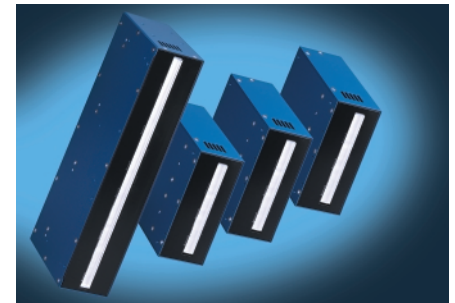

UV-LED MODULE LIGHTNINGCURE® LC-L2

This light source is a compact UV-LED module containing an ultraviolet LED element (365 nm or 385 nm). Designed for low power consumption, it is easy on the environment and allows UV irradiation with less thermal effect.

Its fanless design ensures reliable use even in clean rooms. The same functions as those of the conventional UV irradiators are included, such as output intensity adjustment and irradiation time setting, etc. Various types of condenser lenses are available as options that allow to obtain irradiation patterns according to the application.



UV BONDING EQUIPMENT

We design and configure simple UV curing or bonding equipment combined with dispensers and other devices.

We also welcome your queries regarding adhesive, bonding agents and syringes. Feel free to contact our sales office.

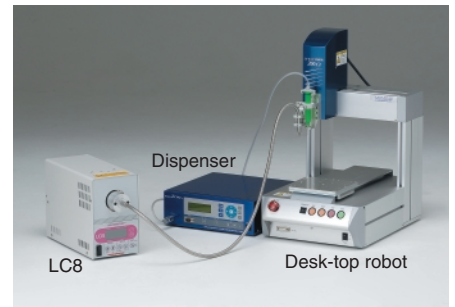

* **LIGHTNINGCURE** is registered trademark of Hamamatsu Photonics K.K. in Japan, U.S.A. and EU.

Subject to local technical requirements and regulations, availability of products included in this promotional material may vary. Please consult with our sales office. Information furnished by HAMAMATSU is believed to be reliable. However, no responsibility is assumed for possible inaccuracies or omissions. Specifications are subject to change without notice. No patent rights are granted to any of the circuits described herein. ©2014 Hamamatsu Photonics K.K.

HAMAMATSU PHOTONICS K.K. www.hamamatsu.com

HAMAMATSU PHOTONICS K.K., Electron Tube Division

314-5, Shimokanzo, Iwata City, Shizuoka Pref., 438-0193, Japan, Telephone: (81)539/62-5248, Fax: (81)539/62-2205

U.S.A.: Hamamatsu Corporation: 360 Foothill Road, Bridgewater, N.J. 08807-0910, U.S.A., Telephone: (1)908-231-0960, Fax: (1)908-231-1218 E-mail: usa@hamamatsu.com

Germany: Hamamatsu Photonics Deutschland GmbH: Arzbergerstr. 10, D-82211 Herrsching am Ammersee, Germany, Telephone: (49)8152-375-0, Fax: (49)8152-2658 E-mail: info@hamamatsu.de

France: Hamamatsu Photonics France S.A.R.L.: 19, Rue du Saule Trapu, Parc du Moulin de Massy, 91882 Massy Cedex, France, Telephone: (33)1 69 53 71 00, Fax: (33)1 69 53 71 10 E-mail: infos@hamamatsu.fr

United Kingdom: Hamamatsu Photonics UK Limited: 2 Howard Court, 10 Tewin Road, Welwyn Garden City, Hertfordshire AL7 1BW, United Kingdom, Telephone: (44)1707-294888, Fax: (44)1707-325777 E-mail: info@hamamatsu.co.uk

North Europe: Hamamatsu Photonics Norden AB: Torshamnsgatan 35 SE-164 40 Kista, Sweden, Telephone: (46)8-509-031-00, Fax: (46)8-509-031-01 E-mail: info@hamamatsu.se

Italy: Hamamatsu Photonics Italia S.r.l.: Strada della Moia, 1 int. 6, 20020 Arese (Milano), Italy, Telephone: (39)02-93581733, Fax: (39)02-93581741 E-mail: info@hamamatsu.it

China: Hamamatsu Photonics (China) Co., Ltd.: B1201 Jiaming Center, No.27 Dongsanhuan Beilu, Chaoyang District, Beijing 100020, China, Telephone: (86)10-6586-6006, Fax: (86)10-6586-2866 E-mail: hpc@hamamatsu.com.cn

TLSZ1008E03
JUN. 2014 IP
(2000)