

Choisissez votre palonnier... Choose your

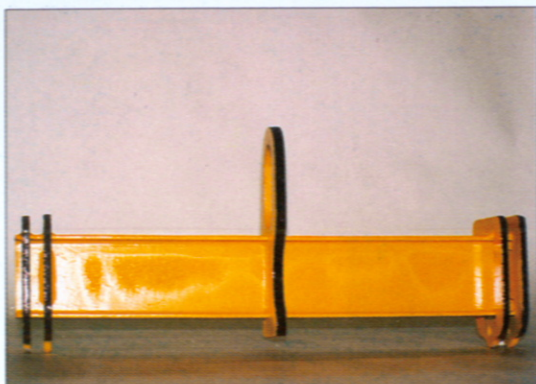

M1

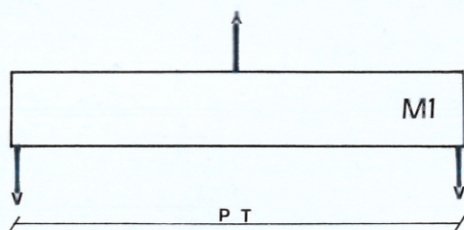

2 suspentes inférieures fixes.
2 fixed lower lifting points.
2 untere starre Befestigungen.

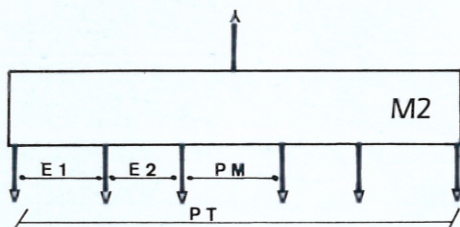

X Suspentes inférieures fixes.
X Fixed lower lifting points.
X Untere starre Befestigungen bzw. Aufhängungen.

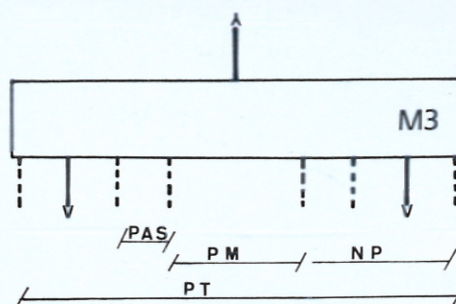

2 suspentes inférieures mobiles.
2 adjustable lower lifting points.
2 untere verstellbare Befestigungen oder Aufhängungen.

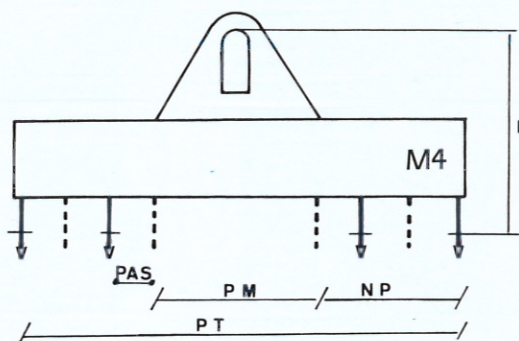

X Suspentes inférieures mobiles.
X Adjustable lower lifting lug.
X Untere verstellbare Befestigungen.

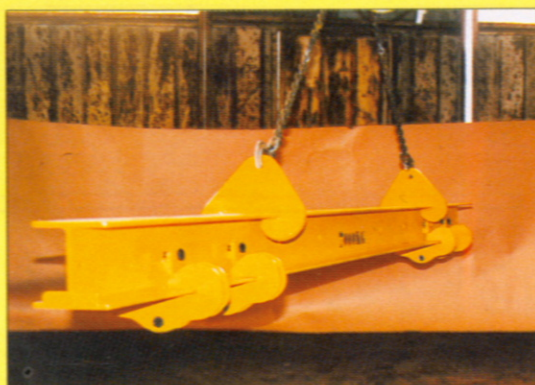

M5

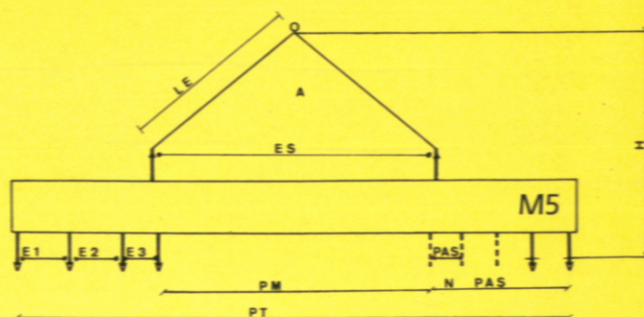

2 ou plus de suspentes inférieures fixes ou mobiles.
2 or more adjustables or fixed lower lifting points.
2 oder mehr verstellbare oder starre Aufhängungen.

ifting beam... Suchen Sie sich Ihre Traverse aus...



I1

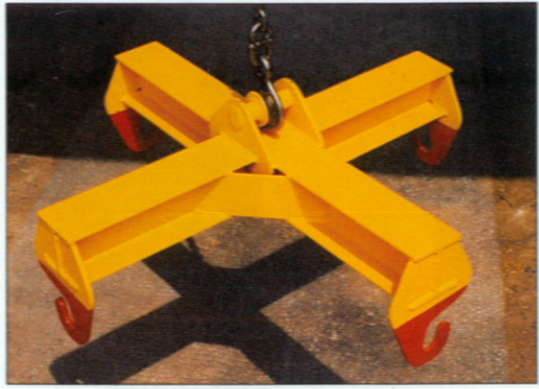

X1

Réglables ou fixes.
Adjustable or fixed.
Verstellbar oder starr.

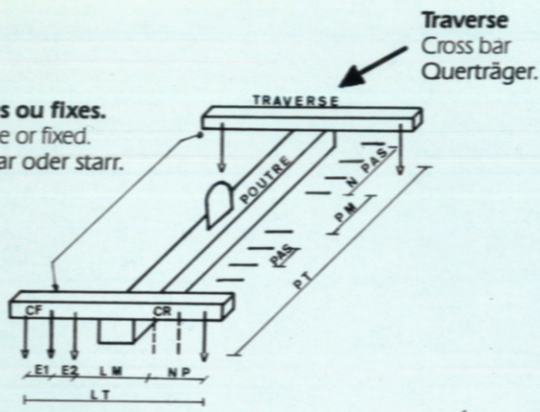

Traverse
Cross bar
Querträger.

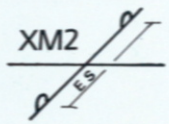
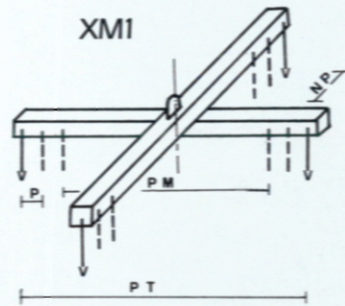
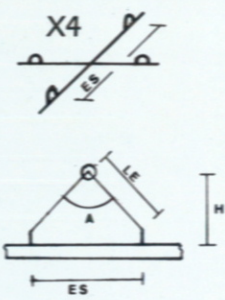
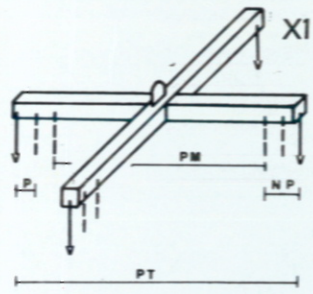

Rotation poutre inférieure.
Lower rotating beam.
Unterer Träger drehbar.

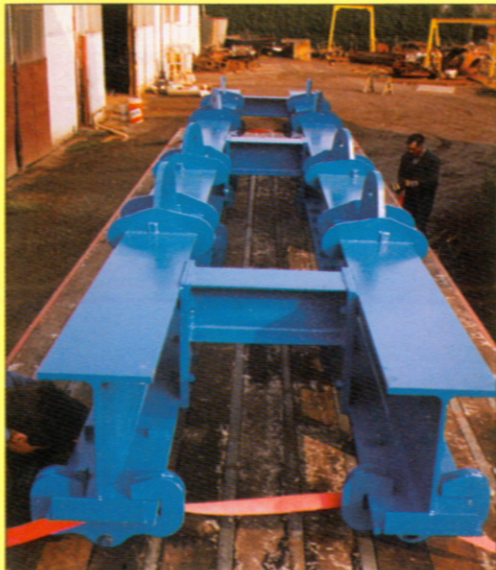
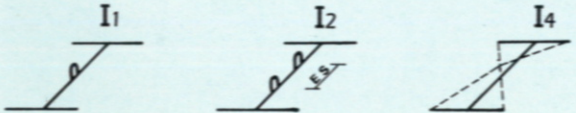

C4

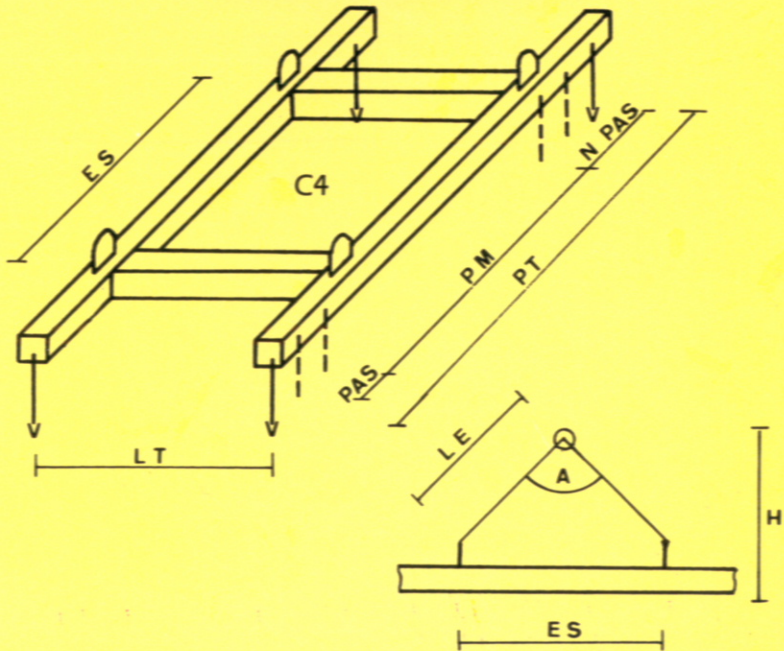

Choisissez votre préhension

Choose your style of lifting point
Wählen Sie die Aufhängungsart

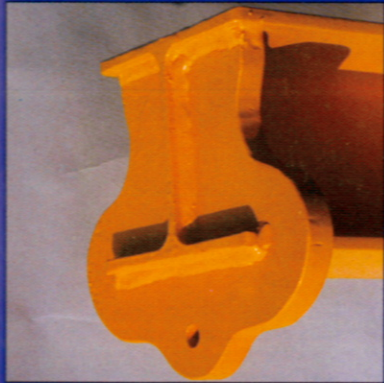

Ref. 1

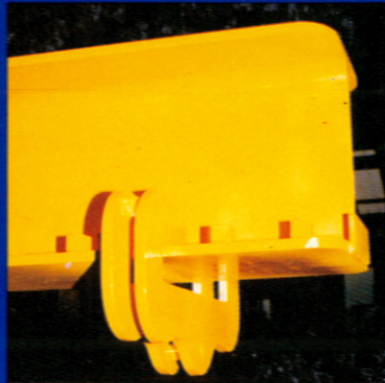

Ref. 2

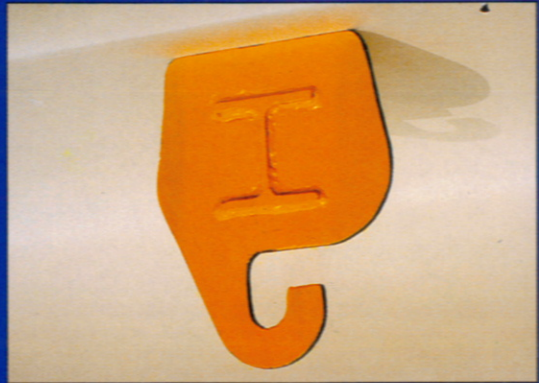

Ref. 3

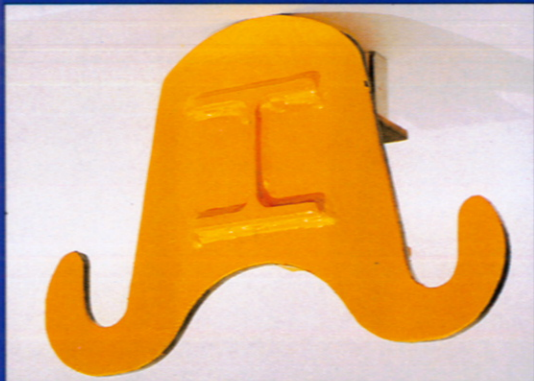

Ref. 4

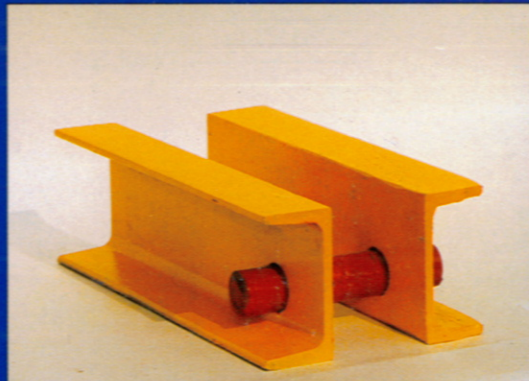

Ref. 5

Toutes autres préhensions sur demande.

All other designs of lifting points to order.

Alle anderen Aufhängungsarten auf Anfrage.



Ref. 6

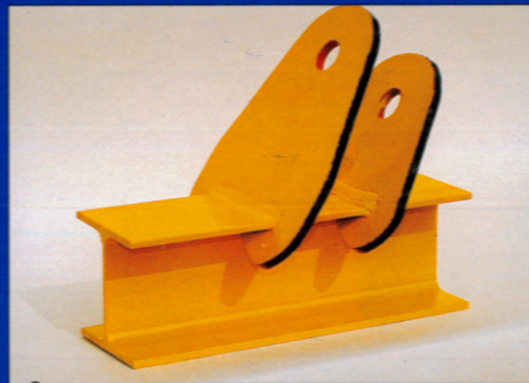

Ref. 7

Les côtes fonctionnelles vous seront indiquées à notre remise d'offre.

Dimensions will be shown in our estimate.

Die Massangaben werden Ihnen in dem Kostenvoranschlag angegeben.



Ref. 8

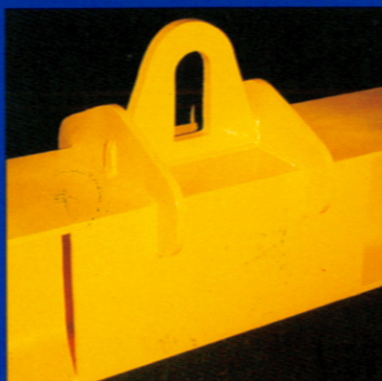

Ref. 9

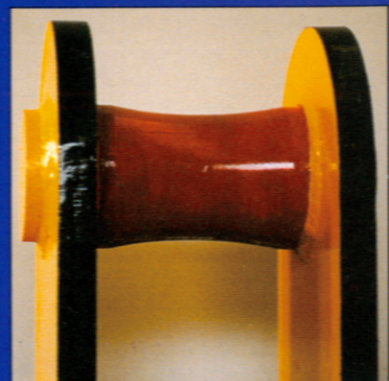

Ref. 10