

# Self-Regulating Trace Heaters

eltherm® 

# Content

<b>From Process to Product</b> The eltherm Story	<b>4</b>
<b>From A to Z</b> Your One-Stop-Shop	<b>6</b>
<b>Self-Regulating Trace Heaters</b>	<b>8</b>
<b>Selection Guide</b> Low Temperature	<b>10</b>
<b>Selection Guide</b> Medium Temperature	<b>12</b>
<b>Selection Guide</b> High Temperature	<b>13</b>
<b>Datasheets</b> Self-Regulating Trace Heaters	<b>14</b>
<b>Accessories</b> Self-Regulating Trace Heater System	<b>36</b>
<b>Applications</b> Self-Regulating Trace Heaters	<b>46</b>
<b>Design Guide</b> Self-Regulating Trace Heater System	<b>48</b>
<b>Questionnaire</b> Electrical Heat Tracing on Pipelines	<b>50</b>
<b>At Your Service</b> eltherm globally	<b>54</b>

**„Understanding the application and finding the most efficient, reliable solution is our daily challenge“**



Our specialists for applications with Self-Regulating Parallel Trace Heaters: Benjamin Knuff, Michelle Schmid and Mohamed Sellami.



#### eltherm in Burbach, Germany

- 1 Production facility I
- 2 Administration, application engineering
- 3 R&D, international sales, eltherm Academy
- 4 Production facility II



## From Process to Product The eltherm Story

Founded in 1991 in Burbach, Germany, eltherm has developed into a global engineering solution provider with own production facilities and a one-stop-shop for electrical heat tracing products and systems. The company has attained worldwide recognition as a turn-key partner for engineering, design, installation and commissioning of electrical heat tracing for complex industrial plants and facilities.

With its own comprehensive production facilities for all types of heating cables and accessories eltherm has built up the engineering expertise to become one of the leading manufacturers of electrical heat tracing systems in the world.

Besides frost protection and temperature maintenance applications up to 900 °C, eltherm is the competent partner for complete system solutions like heating whole chemical or other industrial plants. eltherm proved its potential and expertise in different industries such as oil and gas, power plant, construction, automotive and food.

#### › Portfolio Focus

We provide a comprehensive range of electrical heat tracing products, systems and solutions from A to Z. Your One-Stop-Shop.

#### › Customer Focus

Our focus on the benefits to our clients sets us apart from competitors. We understand and solve our clients' needs with technological passion.

#### › Technical Focus

We specialise in electrical heat tracing. That is our core competence and inspiration.

#### › Global Focus

We are a global engineering company with our own production facilities, serving international markets and projects from 13 locations on 5 continents – and with a staff force of 270.



# From A to Z Your One-Stop-Shop

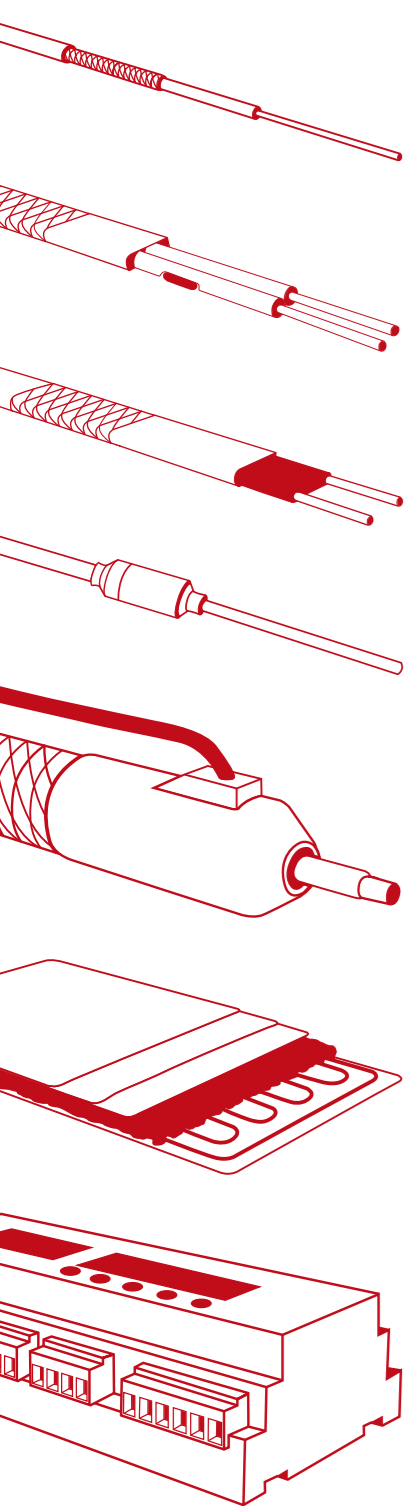

### › Series Resistance Trace Heaters

for freeze prevention and process temperatures in industrial plants and facilities. Applications up to 900 °C.

### › Parallel Resistance Trace Heaters

Parallel trace heaters with constant wattage output and a single end power input. For applications in hazardous and non-hazardous locations.

### › Self-Regulating Trace Heaters

for freeze prevention and temperature maintenance in industry and building & construction. Applications up to 250 °C.

### › Mineral-Insulated Trace Heaters

exclusively manufactured and finished from Alloy 825 or high-quality stainless steel. The unique "Clean Laser Seal" Technology (CLS) guarantees a homogenous, 100% stable system and reliable function up to 700 °C.

### › Heated Analytic, Pressure and Loading Systems

for reliable and safe transport of pressurised or non-pressurised fluids and gases without temperature loss, up to 450 °C.

### › Heating Mats and Jackets

custom-engineered and tailor-made, for heating valves, pumps, drums, barrels, hobbicks and flange covers, up to 450 °C.

### › Power and Control Panels

including temperature sensors, display and operating devices, monitoring and controls plus accessories for reliable, safe functioning.

### › Accessories

for safe and effective assembly and operation of complete heat tracing systems in facilities from small to large.

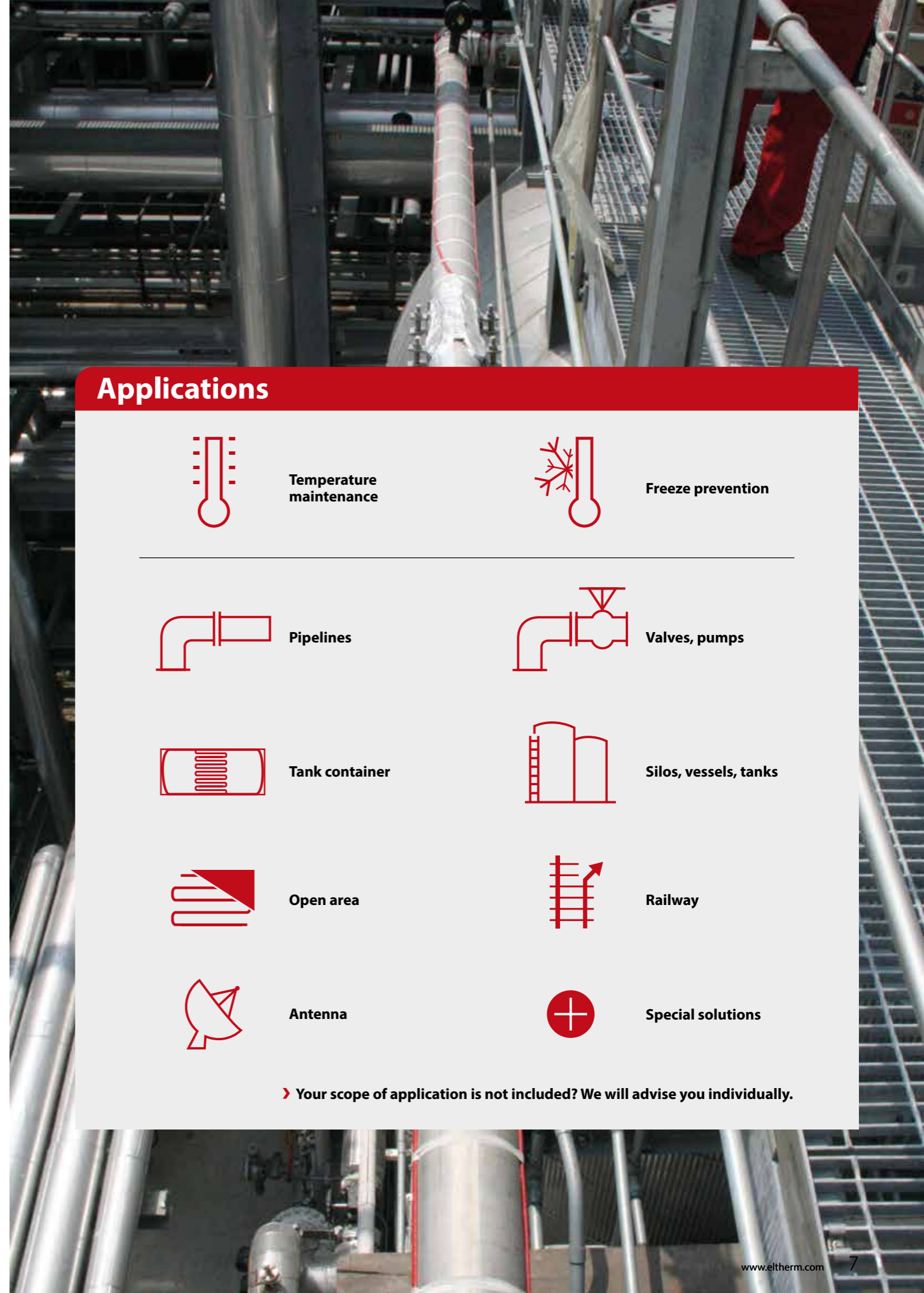

## Applications



Temperature maintenance



Freeze prevention

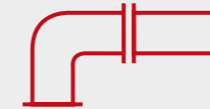

Pipelines

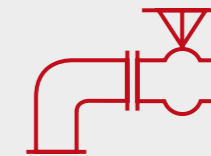

Valves, pumps

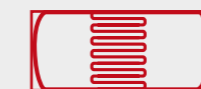

Tank container



Silos, vessels, tanks



Open area



Railway



Antenna



Special solutions

› Your scope of application is not included? We will advise you individually.

## At a Glance

### Benefits

- › Self-regulating with adaptable output
- › Various temperature ranges
- › Demand-orientated output grading
- › High chemical resistance
- › No temperature limitation required (Ex-area)
- › Easy to install
- › Can be cut to length off the roll
- › Fast connection with El-Click

### Design

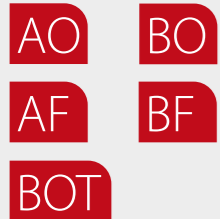

### Approvals



### › Approvals for USA / Canada

Find more in our special product brochure

# Self-Regulating Trace Heaters

Self-regulating trace heaters consist of two parallel bus wires embedded in a heating matrix doped with carbon particles. When the temperature rises in operation, molecular expansion increases the distance between the carbon particles. The resistance increases and output drops. When temperatures fall, this process is reversed and output increases. This physical property means that the heater will never overheat, can be assembled crosswise and can be operated without a temperature limiter. Moreover, selected ELSR heating cables are approved for use in hazardous areas.

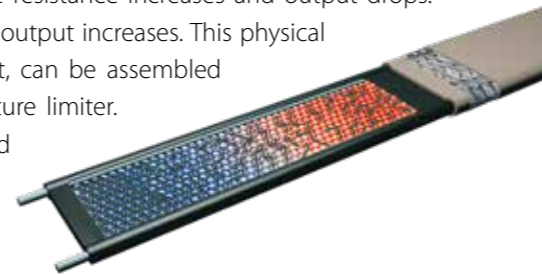

### Application

The ELSR (eltherm-self-regulating) trace heater is used for freeze prevention and temperature maintenance on vessels, pipes, valves, etc. It may be immersed in fluids. For use in aggressive environments (e.g. in chemical or petrochemical industry), the trace heater is coated with a special chemically resistant outer jacket (fluoropolymer), option "BOT".

### Design

A wide selection of self-regulating heater designs to handle almost any application, including service in harsh conditions and corrosive environments.

- AO** Aluminium foil with a thermoplastic outer jacket. Trace heater for all low-temperature and medium-temperature applications, particularly easy to assemble.
- BO** Protective braid with a thermoplastic outer jacket. Trace heater with protective tin-plated copper braid for all low-temperature and medium-temperature applications.
- BOT** Protective braid with fluoropolymer outer jacket (Teflon). Trace heaters with fluoropolymer outer jacket for use in aggressive chemical, oil and fuel environments\*.
- AF** Aluminium foil and outer jacket approved for potable water. Special trace heaters designed for use inside potable water lines in Freeze prevention (-M) applications.
- BF** Protective braid and outer jacket approved for potable water. Special trace heaters with robust protective braid for water and drinking water lines.

- › ELSR-N...1... = Nominal voltage 110 V
- › ELSR-N...2... = Nominal voltage 230 V

We also offer trace heaters with braid only, without outer jacket, upon request.

\*A detailed list of chemical resistances is available online.

## Checklist

### The Self-Regulating Trace Heating System

- |                                |   |
|--------------------------------|---|
| <b>A</b> Trace Heater          | <b>F</b> Fasteners and Self-adhesive Tapes, Foils |
| <b>B</b> Power Connection Kit  | <b>G</b> Insulation Bushing                       |
| <b>C</b> End Termination Kit   | <b>H</b> Warning Sign                             |
| <b>D</b> Junction Box          | <b>I</b> Temperature Controller                   |
| <b>E</b> Pipe Mounting Bracket | <b>J</b> Temperature Sensor                       |

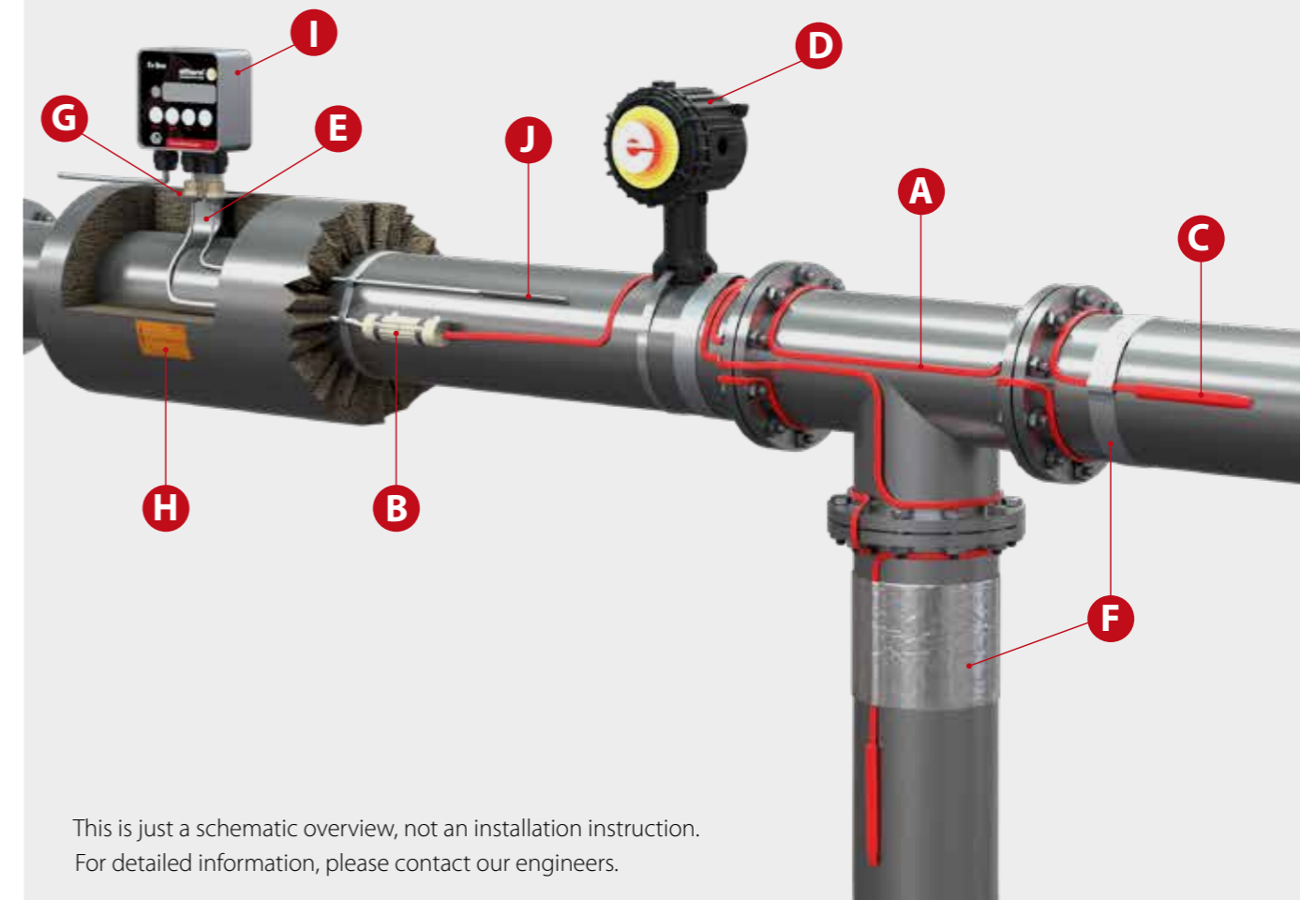

This is just a schematic overview, not an installation instruction. For detailed information, please contact our engineers.

# Selection Guide

Type

Applications

Maximum maintain temperature

Maximum exposure temperature (de-energized)

Nominal output at 10°C

Max. Heating circuit length at 10°C, 16 ampere, 230 V

Hazardous Areas

Page

Low Temperature

**ELSR-N**      **ELSR-LS**      **ELSR-M**

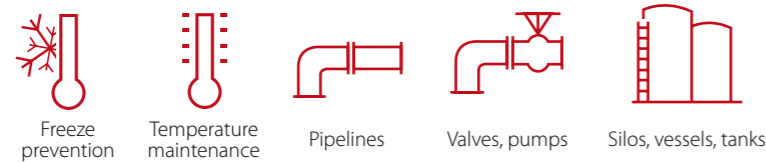

Self-regulating trace heaters for freeze prevention and temperature maintenance in lower temperature ranges, predominantly in industrial applications. ELSR-N and -LS are approved for use in hazardous areas. The BOT version of ELSR-N is resistant to aggressive chemicals, oil and fuel. ELSR-M is very flexible and ideal where small heater dimensions are required.

Maximum maintain temperature	65 °C	65 °C	65 °C
Maximum exposure temperature (de-energized)	80 °C	80 °C	65 °C
Nominal output at 10°C	10 W/m 20 W/m 30 W/m 40 W/m	10 W/m 15 W/m 25 W/m	10 W/m 15 W/m
Max. Heating circuit length at 10°C, 16 ampere, 230 V	177,0 m 109,0 m 83,0 m 57,0 m	196,0 m 160,5 m 103,0 m	126,5 m 105,5 m
Hazardous Areas	•	•	

**14**      **16**      **18**

Low Temperature

**ELSR-M-AF/BF**

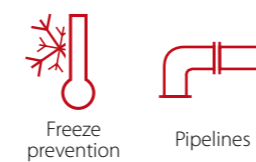

ELSR-M-AF/BF is suited for freeze prevention in pipes and pipelines with seasonal exposure. Typical applications are water supply systems and sanitary facilities on building sites, outdoor events, winter markets etc.

Maximum maintain temperature	65 °C
Maximum exposure temperature (de-energized)	65 °C
Nominal output at 10°C	10 W/m
Max. Heating circuit length at 10°C, 16 ampere, 230 V	89.5 m

**20**

Low Temperature

**ELSR-R**



The ELSR-R line is used where its round geometry facilitates installation in sealing and door profiles. Typical applications are doors and gateways to cold-storage facilities, cold water lines in beverage production and breweries.

Maximum maintain temperature	65 °C
Maximum exposure temperature (de-energized)	65 °C
Nominal output at 10°C	19 W/m      27 W/m
Max. Heating circuit length at 10°C, 16 ampere, 230 V	102.0 m      32.0 m

**22**

# Selection Guide

Type

Applications

Maximum maintain temperature

Maximum exposure temperature (de-energized)

Nominal output at 10°C

Max. Heating circuit length at 10°C, 16 ampere, 230 V

Hazardous Areas

Page

## Medium Temperature

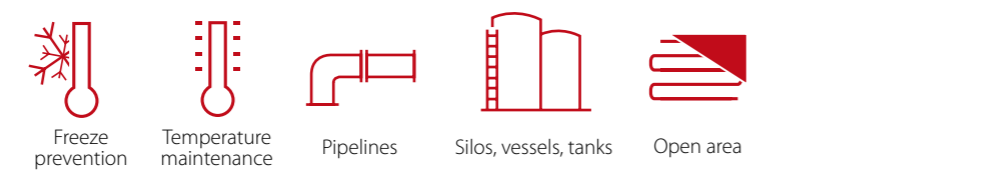

ELSR-W is employed for temperature maintenance on hot water pipelines and fat disposal lines in canteens or commercial kitchens. It is also used for bacteria and legionella prevention in water lines. ELSR-Ramp for freeze prevention is specially designed for concrete ramps and outdoor surfaces. ELSR-FHP was specially developed for frost heave protection in foundations, for instance in LNG terminals.

Maximum maintain temperature		80 °C	80 °C	65 °C (ELSR-FHP-23) 80 °C (ELSR-FHP-38)
Maximum exposure temperature (de-energized)		100 °C	100 °C	80 °C (ELSR-FHP-23) 110 °C (ELSR-FHP-38)
Nominal output at 10°C		water supply lines 9 W/m at 55 °C 13 W/m at 65 °C fat/oil 22 W/m at 40 °C	50 W/m at 10 °C 110 W/m at 5 °C	23 W/m at 5 °C 38 W/m at 5 °C
Max. Heating circuit length at 10°C, 16 ampere, 230 V		113.0 m	73.5 m	at -10 °C 28.0 m at -5 °C 48.5 m at -5 °C 36.5 m

24	26	28
----	----	----

## High Temperature

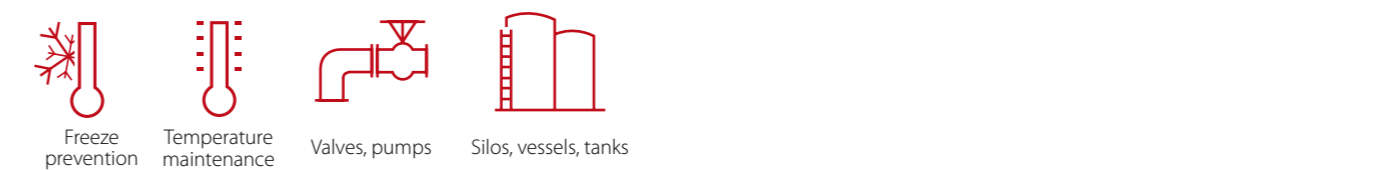

The ELSR-H, -SH and -SHH high temperature trace heater range is designed for temperature maintenance in industrial processes and applications in hazardous areas. The trace heaters' high chemical resistance allows them to be installed in environments with exposure to aggressive influences.

Maximum maintain temperature		120 °C							165 °C					250 °C				
Maximum exposure temperature (de-energized)		210 °C							250 °C					250 °C				
Nominal output at 10°C		10 W/m	15 W/m	20 W/m	30 W/m	45 W/m	60 W/m	75 W/m	15 W/m	35 W/m	45 W/m	75 W/m	90 W/m	15 W/m	30 W/m	45 W/m	60 W/m	75 W/m
Max. Heating circuit length at 10°C, 16 ampere, 230 V		193.0 m	158.0 m	122.0 m	82.0 m	55.0 m	41.0 m	33.0 m	172.0 m	80.0 m	58.0 m	30.0 m	27.0 m	76.0 m	52.0 m	38.0 m	24.0 m	14.0 m

30	32	34
----	----	----

## At a Glance

### Applications

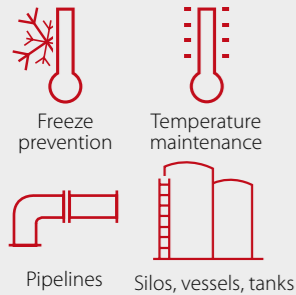

- › Chemistry and Petrochemistry
- › Maritime and offshore
- › Food Processing Industry
- › Water and sanitation utilities

### Benefits

- › Four nominal outputs
- › UV-resistant
- › Moisture proof
- › Junction box for pipe mounting

### Design



### Approvals



- › Trace Heater classification
  - II 2G Ex 60079-30-1 IIC Gb
  - II 2D Ex 60079-30-1 IIIC Db
- › System classification
  - II 2G Ex 60079-30-1 eb IIC T6 Gb
  - II 2D Ex 60079-30-1 tb IIIC T85°C Db
- › Certification
  - EPS IECEx 18.0064U
  - EPS IECEx 19.007X
  - EPS 18 ATEX 1133 U
  - EPS 19 ATEX 1014 X
- › Temperature class
  - T6

# Type ELSR-N

## up to 80 °C

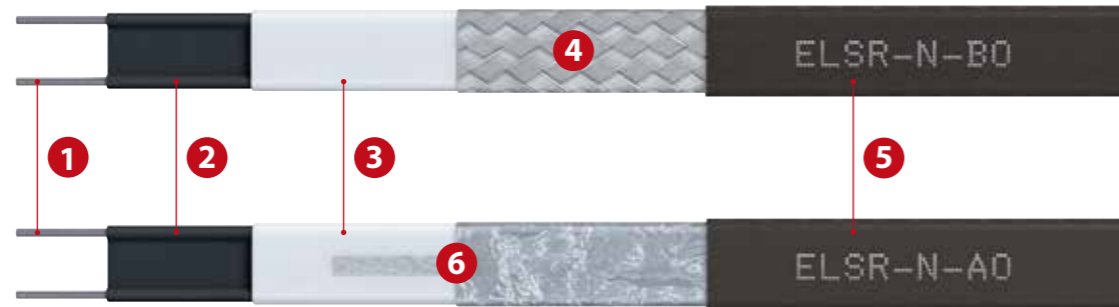

- |   |   |
|---|---|
| <b>1 Bus wire</b><br>Nickel plated copper | <b>4 Protection</b> Protective braid (Cu, tin plated)                                   |
| <b>2 Self-regulating heating element</b>  | <b>5 Outer jacket</b>   |
| <b>3 Insulation</b>                       | <b>6 Protective conductor connection</b><br>see 4 or Cu, tin plated with aluminium foil |

## Checklist ELSR-N

### B + C Power Connection & End Termination

Code	Description	Part No.
ELVB-SRAN-Ex-20	Power connection, glued, Gland M20, brass, Ex d	0X81PND
EL-ECN-ex	Silicone termination cap black, glued, transparent with ex marking	0X81EN1
ELVB-SREx-25	Power connection, glued, Gland M25 x 1,5, PE, Ex e	0X81PA1
Ex-Con-SR	Ex connection sleeve Ø 36 x 210 mm 4J	0X81125
ELVB-SREx-IT	Power connection, glued, without gland	091AIT1
ELVB-SRA-25	Power connection, glued, Gland M25 x 1,5, PE	091A010
EL-ECN	Silicone termination cap, glued, transparent	09112N1
ELVB-SRV-N-L-W	Connection set, shrink-fit	0911116
El-Clc P/S	El-Clc P Fast connector with integrated cold lead	09ClcP
	El-Clc S Fast connector T-splice	09ClcS

### D Junction Boxes

Code	Description	Part No.
ELAK-Ex-3.5	122 x 120 x 90 mm, 1 heater, capillary thermostat, IP 66	0X80055
ELAK-Ex-3.7	122 x 120 x 90, 1-3 heaters, power supply lead max. 10 mm <sup>2</sup> , IP66	0X80057
Ex-it-R	Ø 150 x 125 mm, 3 heaters, 1 Pt100 power supply lead, incl. mounting stand, IP 65	0X80070
ELAK-2	104 x 104 x 70 mm, polycarbonate, breakouts 7x M25, IP 66	0920030
ELAK-5	122 x 120 x 90 mm, polyester, 3 breakouts M25, IP 66	0920013
ELAK-5.1	130 x 130 x 75 mm, polycarbonate, breakouts 9x M20/M25, IP 66	0920002
ELAK-RS-T	150 x 125 mm, twin Pt100, 3 heaters incl. mounting stand, IP 65	0920059

### J Temperature Sensors

Code	Description	Part No.
ELTF-PTEx.2	Pt100, 4 conductors, 3 m PTFE cable	0X70002
ELTF-PTEx.4	2x Pt100, 3 conductors, 3 m cold lead	0X70030
ELTF-PT.1	Pt100, 5 x 50 mm PVC 5 m	0650001
ELTF-PT.3	Pt100, 2 conductors, 5 x 50 mm, 3 m PTFE cable	0650003
ELTF-PT.3.1	Pt100, 3 conductors, 5 x 50 mm, 3 m PTFE cable	0650002

## Technical Information

Maximum maintain temperature	65 °C
Maximum exposure temperature (de-energized)	80 °C
Nominal voltage*	230 V
Bending radius, min.	25 mm
Installation temperature, min.	-60 °C

\*Further power inputs on request

### Heating circuit lengths on the following conditions

- › 230 V nominal voltage
- › Delayed action circuit breakers (C-characteristic) with 80 % maximum load
- › Maximum 10 % line voltage drop on heating cable bus wire
- › Power connection to one heater end

### ELSR-N...-2 output

(on insulated metallic pipes in accordance with EN 62395-1)

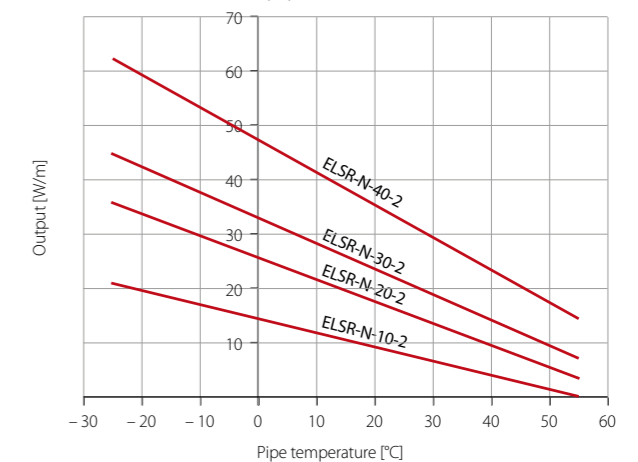

Switch-on temperature (°C)	Nominal cutout value (A)	Heating circuit length (m) for			
		ELSR-N-10-2	ELSR-N-20-2	ELSR-N-30-2	ELSR-N-40-2
10	10	128.0	68.0	52.0	36.0
	16	177.0	109.0	83.0	57.0
	20	177.0	129.0	104.0	71.0
	25	177.0	129.0	113.0	89.0
	32	177.0	129.0	113.0	94.0
0	10	106.0	57.0	45.0	31.0
	16	160.0	92.0	71.0	50.0
	20	160.0	115.0	89.0	62.0
	25	160.0	119.0	105.0	78.0
	32	160.0	119.0	105.0	88.0
-10	10	90.0	50.0	39.0	28.0
	16	144.0	79.0	63.0	44.0
	20	149.0	99.0	78.0	55.0
	25	149.0	111.0	98.0	69.0
	32	149.0	111.0	98.0	83.0
-20	10	78.0	44.0	35.0	25.0
	16	125.0	70.0	56.0	40.0
	20	139.0	87.0	69.0	50.0
	25	139.0	104.0	87.0	62.0
	32	139.0	104.0	87.0	78.0
-40	10	62.0	35.0	28.0	21.0
	16	99.0	56.0	45.0	33.0
	20	124.0	71.0	57.0	42.0
	25	124.0	88.0	71.0	52.0
	32	124.0	88.0	71.0	66.0

Type	Nominal output	Dimensions approx. (mm)	Weight approx. (g/m)	Part No.
ELSR-N-10-2-AO	10 W/m at 10 °C	13.6 x 5.5	91	B0200130
ELSR-N-10-2-BO	10 W/m at 10 °C	14.1 x 5.8	108	B0200110
ELSR-N-10-2-BOT	10 W/m at 10 °C	13.8 x 5.6	108	B0200119
ELSR-N-20-2-AO	20 W/m at 10 °C	13.6 x 5.5	91	B0200230
ELSR-N-20-2-BO	20 W/m at 10 °C	14.1 x 5.8	108	B0200210
ELSR-N-20-2-BOT	20 W/m at 10 °C	13.8 x 5.6	108	B0200219
ELSR-N-30-2-AO	30 W/m at 10 °C	13.6 x 5.5	91	B0200330
ELSR-N-30-2-BO	30 W/m at 10 °C	14.1 x 5.8	108	B0200310
ELSR-N-30-2-BOT	30 W/m at 10 °C	13.8 x 5.6	108	B0200319
ELSR-N-40-2-AO	40 W/m at 10 °C	13.6 x 5.5	91	B0200430
ELSR-N-40-2-BO	40 W/m at 10 °C	14.1 x 5.8	108	B0200410
ELSR-N-40-2-BOT	40 W/m at 10 °C	13.8 x 5.6	108	B0200419



## At a Glance

### Applications

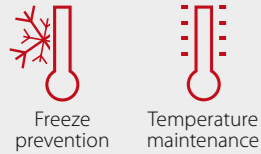

- › Chemistry and Petrochemistry
- › Maritime and offshore
- › Food Processing Industry
- › Water and sanitation utilities

### Benefits

- › Three nominal outputs
- › UV-resistant
- › Moisture proof
- › Small dimensions

### Design



### Approvals



- › Trace Heater classification  
EPS II 2G Ex 60079-30-1 IIC Gb  
EPS II 2D Ex 60079-30-1 IIIC Db
- › System classification  
IBExU II 2G Ex 60079-30-1 eb IIC T6 Gb  
II 2D Ex 60079-30-1 tb IIIC TX Db
- › Certification  
EPS 19 ATEX 1 215 U  
IBExU 09 ATEX 1047 X
- › Temperature class  
T6

# Type ELSR-LS up to 80 °C



- |  |   |
|--|---|
| <p><b>1 Bus wire</b><br/>Nickel plated copper</p> <p><b>2 Self-regulating heating element</b></p> <p><b>3 Insulation</b></p> | <p><b>4 Protection</b> Protective braid (Cu, tin plated)</p> <p><b>5 Outer jacket</b> TPE-O</p> <p><b>6 Protective conductor connection</b><br/>see 4 or Cu, tin plated with aluminium foil</p> |
|--|---|

## Checklist ELSR-LS

### B + C Power Connection & End Termination

Part No.	Description	Part No.
ELVB-SREx-25	Power connection, glued, Gland M25 x 1,5, PE, Ex e	0X81PA1
ELVB-SRAL-Ex-20	Power connection, glued, Gland M20, brass	0X81PLD
EL-ECL-ex	Silicone termination cap black, glued, transparent with ex marking	0X81EL1
Ex-Con-SR	Ex connection sleeve Ø 36 x 210 mm 4J	0X81125
ELVB-SRA-25	Power connection, glued, Gland M25 x 1,5, PE	091A010
ELVB-SRV-N-L-W	Connection set, shrink-fit	0911116
EL-ECL	Silicone termination cap, glued, transparent	09112L1
El-Clıc P/S	El-Clıc P Fast connector with integrated cold lead	09ClıcP
	El-Clıc S Fast connector T-splice	09ClıcS

### D Junction Boxes

Part No.	Description	Part No.
ELAK-Ex-3.5	122 x 120 x 90 mm, 1 heater, capillary thermostat, IP 66	0X80055
ELAK-Ex-3.7	122 x 120 x 90, 1-3 heaters, power supply lead max. 10 mm <sup>2</sup> , IP66	0X80057
ELAK-2	104 x 104 x 70 mm, polycarbonate, breakouts 7x M25, IP 66	0920030
ELAK-5	122 x 120 x 90 mm, polyester, 3 breakouts M25, IP 66	0920013
ELAK-5.1	130 x 130 x 75 mm, polycarbonate, breakouts 9x M20/M25, IP 66	0920002
ELAK-RS-T	150 x 125 mm, twin Pt100, 3 heaters incl. mounting stand, IP 65	0920059

### J Temperature Sensors

Part No.	Description	Part No.
ELTF-PTEx.2	Pt100, 4 conductors, 3 m PTFE cable	0X70002
ELTF-PTEx.4	2x Pt100, 3 conductors, 3 m cold lead	0X70030
ELTF-PT.1	Pt100, 5 x 50 mm PVC 5 m	0650001
ELTF-PT.3	Pt100, 2 conductors, 5 x 50 mm, 3 m PTFE cable	0650003
ELTF-PT.3.1	Pt100, 3 conductors, 5 x 50 mm, 3 m PTFE cable	0650002

## Technical Information

Maximum maintain temperature	65 °C
Maximum exposure temperature (de-energized)	80 °C
Nominal voltage*	230 V
Bending radius, min.	25 mm
Installation temperature, min.	-60 °C

\*Further power inputs on request

### Heating circuit lengths on the following conditions

- › 230 V nominal voltage
- › Delayed action circuit breakers (C-characteristic) with 80 % maximum load
- › Maximum 10 % line voltage drop on heating cable bus wire
- › Power connection to one heater end

### ELSR-LS-...-2 output

(on insulated metallic pipes in accordance with EN 62395-1)

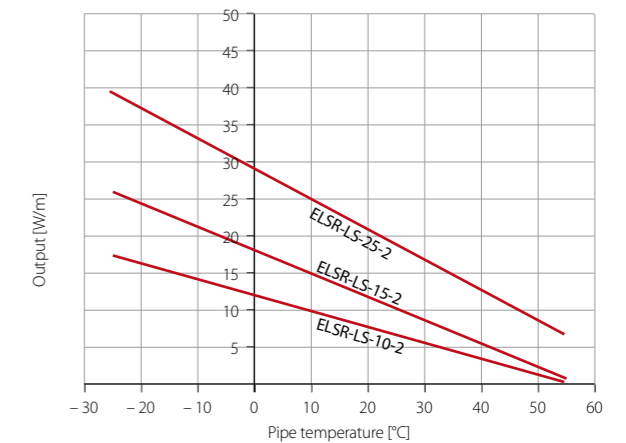

Switch-on temperature (°C)	Nominal output value (A)	Heating circuit length (m) for		
		ELSR-LS-10-2	ELSR-LS-15-2	ELSR-LS-25-2
10	10	152.0	103.0	64.0
	16	196.0	160.5	103.0
	20	196.0	160.5	126.0
	25	196.0	160.5	126.0
0	10	141.0	84.0	54.0
	16	188.5	134.0	87.0
	20	188.5	145.0	108.0
	25	188.5	145.0	116.0
-10	10	119.0	71.0	47.0
	16	173.5	114.0	75.0
	20	173.5	133.0	94.0
	25	173.5	133.0	107.5
-20	10	103.0	62.0	37.5
	16	161.0	99.0	60.0
	20	161.0	124.0	75.0
	25	161.0	124.0	94.0

Type	Nominal output	Dimensions approx. (mm)	Weight approx. (g/m)	Part No.
ELSR-LS-10-2-BO	10 W/m at 10 °C	11,0 x 5,6	98	B0223102
ELSR-LS-10-2-AO	10 W/m at 10 °C	10,3 x 5,3	78	B0223104
ELSR-LS-15-2-BO	15 W/m at 10 °C	11,0 x 5,6	98	B0223152
ELSR-LS-15-2-AO	15 W/m at 10 °C	10,3 x 5,3	78	B0223154
ELSR-LS-25-2-BO	25 W/m at 10 °C	11,0 x 5,6	98	B0223252
ELSR-LS-25-2-AO	25 W/m at 10 °C	10,3 x 5,3	78	B0223254

**At a Glance**

**Applications**

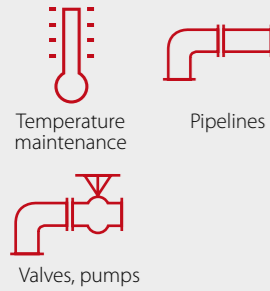

- › Food Processing Industry
- › Water and sanitation utilities

**Benefits**

- › Two nominal outputs
- › UV-resistant
- › Moisture proof
- › Small dimensions

**Design**



**Approvals**



# Type ELSR-M

up to 65 °C



<b>1 Bus wire</b>	Nickel plated copper
<b>2 Self-regulating heating element</b>	
<b>3 Insulation</b>	
<b>4 Protection</b>	Protective braid (Cu, tin plated)
<b>5 Outer jacket</b>	TPE-O
<b>6 Protective conductor connection</b>	see 4 or Cu, tin plated with aluminium foil

## Checklist ELSR-M

**B + C Power Connection & End Termination**

ELVB-SRAM-25	Power connection, shrink-fit, Gland M25 x 1,5, PE	091A015
EL-ECM	Silicone termination cap, glued, transparent	09112M1
ELVB-SRV-M	Connection set, shrink-fit	0911122

**D Junction Boxes**

ELAK-2	104 x 104 x 70 mm, polycarbonate, breakouts 7x M25, IP 66	0920030
ELAK-5	122 x 120 x 90 mm, polyester, 3 breakouts M25, IP 66	0920013
ELAK-5.1	130 x 130 x 75 mm, polycarbonate, breakouts 9x M20/M25, IP 66	0920002

**J Temperature Sensors**

ELTF-PT.1	Pt100, 5 x 50 mm PVC 5 m	0650001
ELTF-PT.3	Pt100, 2 conductors, 5 x 50 mm, 3 m PTFE cable	0650003
ELTF-PT.3.1	Pt100, 3 conductors, 5 x 50 mm, 3 m PTFE cable	0650002

## Technical Information

<b>Maximum maintain temperature</b>	65 °C
<b>Maximum exposure temperature (de-energized)</b>	65 °C
<b>Nominal voltage</b>	230 V
<b>Bending radius, min.</b>	25 mm
<b>Installation temperature, min.</b>	-45 °C

**Heating circuit lengths on the following conditions**

- › 230 V nominal voltage
- › Delayed action circuit breakers (C-characteristic) with 80 % maximum load
- › Maximum 10 % line voltage drop on heating cable bus wire
- › Power connection to one heater end

**ELSR-M-...-2 output**

(on insulated metallic pipes in accordance with EN 62395-1)

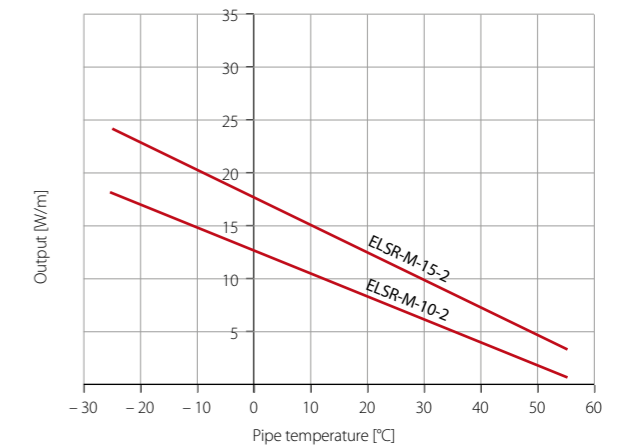

Switch-on temperature (°C)	Nominal cutout value (A)	Heating circuit length (m) for	
		ELSR-M-10-2	ELSR-M-15-2
10	10	126.5	98.0
	16	126.5	105.5
	20	126.5	105.5
0	10	115.5	83.0
	16	115.5	97.5
	20	115.5	97.5
-10	10	100.0	72.0
	16	106.5	91.0
	20	106.5	91.0
-20	10	87.0	64.0
	16	99.5	85.5
	20	99.5	85.5
-40	10	69.0	52.0
	16	88.5	77.0
	20	88.5	77.0

Type	Nominal output	Dimensions approx. (mm)	Weight approx. (g/m)	Part No.
ELSR-M-10-2-AO	10 W/m at 10 °C	8.0 x 5.5	53	B0225110
ELSR-M-10-2-BO	10 W/m at 10 °C	8.5 x 5.8	62	B0225102
ELSR-M-15-2-AO	15 W/m at 10 °C	8.0 x 5.5	53	B0225160
ELSR-M-15-2-BO	15 W/m at 10 °C	8.5 x 5.8	62	B0225152

## At a Glance

### Applications

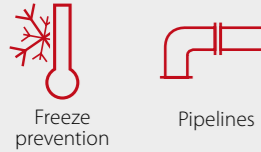

- › In-pipe trace heating approved for potable water pipes and flexible tubes

### Benefits

- › Officially approved
- › Can be used in liquids
- › Suitable for drinking water
- › Small dimensions

### Design



### Approvals



- › Certification K-229437-13-Bs/st

# Type ELSR-M-AF/BF

## up to 65 °C

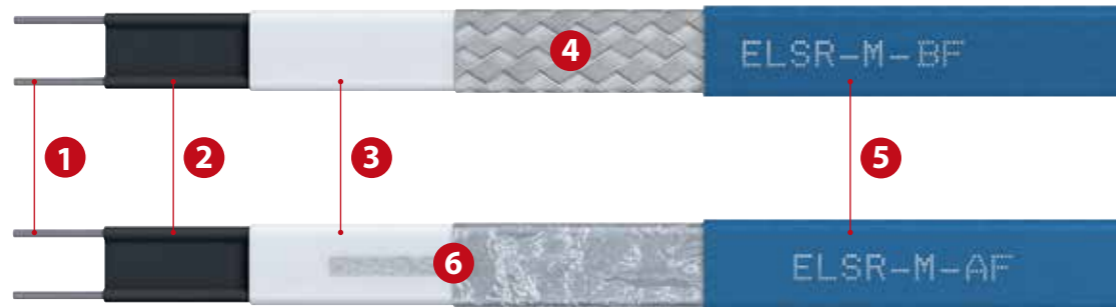

<b>1 Bus wire</b>	Nickel plated copper
<b>2 Self-regulating heating element</b>	
<b>3 Insulation</b>	
<b>4 Protection</b>	Protective braid (Cu, tin plated)
<b>5 Outer jacket</b>	TPE-O
<b>6 Protective conductor connection</b>	see 4 or Cu, tin plated with aluminium foil

## Checklist ELSR-M-AF/BF

### B + C Power Connection & End Termination

ELVB-70	Cable gland Ms 3/4", brass, approved for drinking water	0911703
ELVB-71	Y-connector 32 mm, brass, approved for drinking water	0911704
ELVB-SRAM-25	Power connection, shrink-fit, Gland M25 x 1,5, PE	091A015
EL-ECMF	Silicone termination cap, glued, transparent	09112MF
ELVB-SRV-M	Connection set, shrink-fit	0911122

### D Junction Boxes

ELAK-2	104 x 104 x 70 mm, polycarbonate, breakouts 7x M25, IP 66	0920030
ELAK-5	122 x 120 x 90 mm, polyester, 3 breakouts M25, IP 66	0920013
ELAK-5.1	130 x 130 x 75 mm, polycarbonate, breakouts 9x M20/M25, IP 66	0920002

### J Temperature Sensors

ELTF-PT.1	Pt100, 5 x 50 mm PVC 5 m	0650001
ELTF-PT.3	Pt100, 2 conductors, 5 x 50 mm, 3 m PTFE cable	0650003
ELTF-PT.3.1	Pt100, 3 conductors, 5 x 50 mm, 3 m PTFE cable	0650002

## Technical Information

<b>Maximum maintain temperature</b>	65 °C
<b>Maximum exposure temperature (de-energized)</b>	65 °C
<b>Nominal voltage</b>	230 V
<b>Bending radius, min.</b>	25 mm
<b>Installation temperature, min.</b>	-45 °C

### Heating circuit lengths on the following conditions

- › 230 V nominal voltage
- › Delayed action circuit breakers (C-characteristic) with 80 % maximum load
- › Maximum 10 % line voltage drop on heating cable bus wire
- › Power connection to one heater end

### ELSR-M-10-2-AF/BF output

(In ice water)

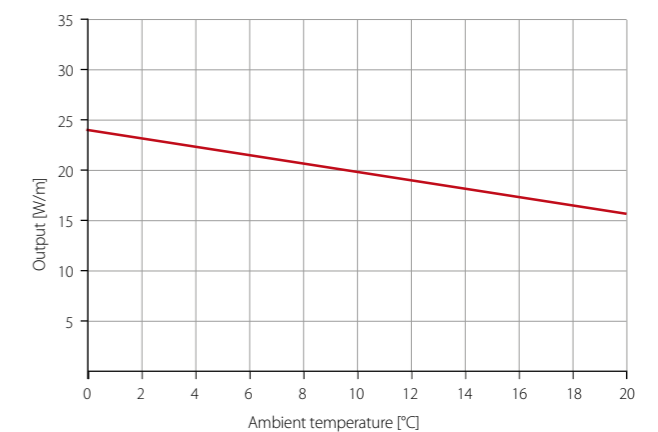

Switch-on temperature (°C)	Nominal cutout value (A)	Heating circuit length (m) for	
		ELSR-M-10-2-AF/BF	
10	10	74.0	
	16	89.5	
	20	89.5	
0	10	61.5	
	16	89.5	
	20	89.5	
-30	10	61.5	
	16	89.5	
	20	89.5	

Type	Nominal output	Dimensions approx. (mm)	Weight approx. (g/m)	Part No.
ELSR-M-10-2-BF	10 W/m at 10 °C	7.5 x 4.9	62	B0225104
ELSR-M-10-2-AF	10 W/m at 10 °C	7.0 x 4.6	53	B0225105

## At a Glance

### Applications



Freeze prevention



Special solutions

- › Doors and seals of refrigerating chambers
- › Profile Heating
- › Boarding Bridges

### Benefits

- › Round design
- › Moisture proof
- › UV-resistant
- › Ideal for profile installation

### Design

**BOT**

### Approvals



# Type ELSR-R

## up to 65 °C

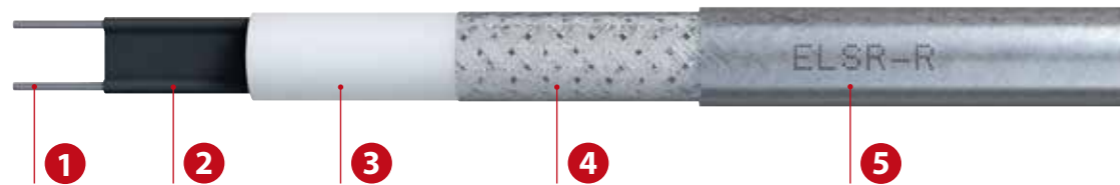

<b>1 Bus wire</b>	Nickel plated copper
<b>2 Self-regulating heating element</b>	
<b>3 Insulation</b>	
<b>4 Protection</b>	Protective braid (Cu, tin plated)
<b>5 Outer jacket</b>	Fluoropolymer

## Checklist ELSR-R

### B + C Power Connection & End Termination

ELVB-SRAR-25	Power connection, shrink-fit, Gland M25 x 1,5, PE	091A020
EL-ECM	Silicone termination cap, glued, transparent	09112M1
ELVB-SRV-M	Connection set, shrink-fit	0911122

### D Junction Boxes

ELAK-2	104 x 104 x 70 mm, polycarbonate, breakouts 7x M25, IP 66	0920030
ELAK-5	122 x 120 x 90 mm, polyester, 3 breakouts M25, IP 66	0920013
ELAK-5.1	130 x 130 x 75 mm, polycarbonate, breakouts 9x M20/M25, IP 66	0920002

### J Temperature Sensors

ELTF-PT.1	Pt100, 5 x 50 mm PVC 5 m	0650001
ELTF-PT.3	Pt100, 2 conductors, 5 x 50 mm, 3 m PTFE cable	0650003
ELTF-PT.3.1	Pt100, 3 conductors, 5 x 50 mm, 3 m PTFE cable	0650002

## Technical Information

<b>Maximum maintain temperature</b>	65 °C
<b>Maximum exposure temperature (de-energized)</b>	65 °C
<b>Nominal voltage</b>	230 V
<b>Bending radius, min.</b>	30 mm
<b>Installation temperature, min.</b>	-30 °C

### Heating circuit lengths on the following conditions

- › 230 V nominal voltage
- › Delayed action circuit breakers (C-characteristic) with 80 % maximum load
- › Maximum 10 % line voltage drop on heating cable bus wire
- › Power connection to one heater end

### ELSR-R-...-2-BOT output (in a filled water pipeline)

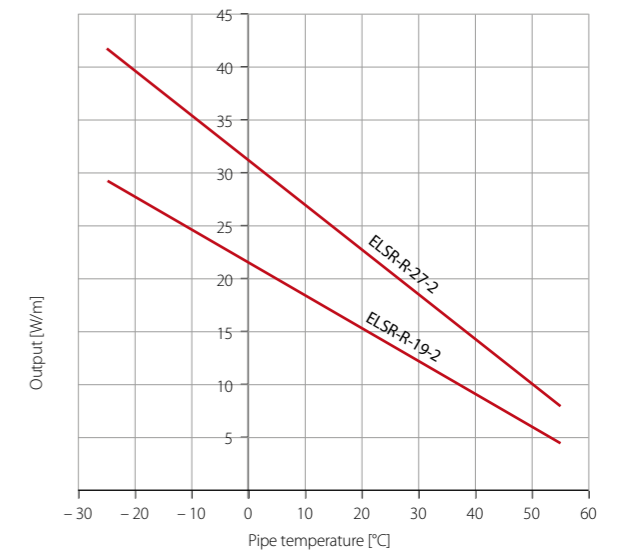

Switch-on temperature (°C)	Nominal cutout value (A)	Heating circuit length (m) for	
		ELSR-R-19-2	ELSR-R-27-2
10	10	75.0	20.0
	16	102.0	32.0
	20	102.0	40.0
0	10	62.0	16.5
	16	94.0	26.5
	20	94.0	33.0
-10	10	51.0	13.5
	16	81.5	21.5
	20	88.0	27.0
-20	10	41.0	11.0
	16	65.5	17.5
	20	82.0	22.0
-40	10	30.0	7.5
	16	48.0	12.0
	20	60.0	15.0

Type	Nominal output	Dimensions approx. (mm)	Weight approx. (g/m)	Part No.
ELSR-R-19-2-BOT	19 W/m at 10 °C	7.3	77	B0200507
ELSR-R-27-2-BOT	27 W/m at 10 °C	7.3	74	B0200605

Other versions are available upon request. This heating cable has specially been developed for the use with doors of refrigerating chambers. Please contact our engineers for more details on our ELSR-R.

## At a Glance

### Applications

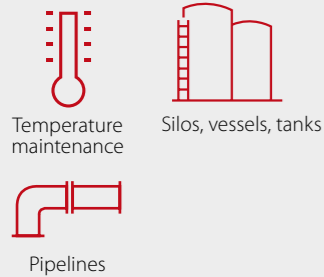

- › Fat-containing wastewater pipes in canteens and large-scale kitchens
- › Legionella prevention on hot water pipes

### Benefits

- › Two nominal outputs
- › Moisture proof

### Design



### Approvals



# Type ELSR-W

## up to 100 °C

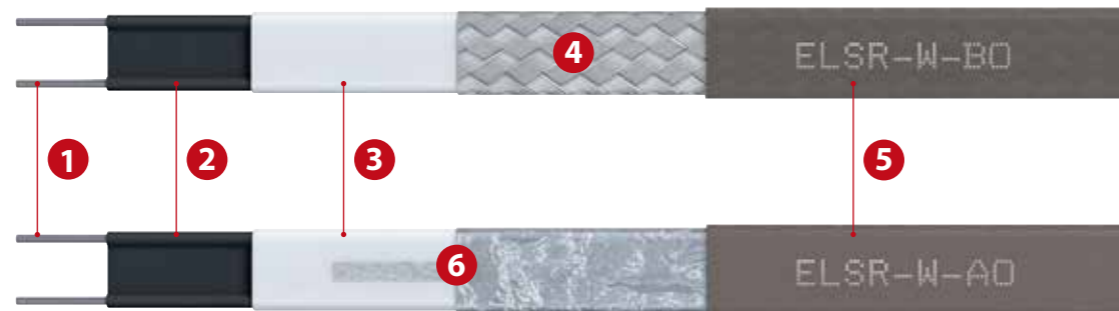

<b>1 Bus wire</b>	Nickel plated copper
<b>2 Self-regulating heating element</b>	
<b>3 Insulation</b>	
<b>4 Protection</b>	Protective braid (Cu, tin plated)
<b>5 Outer jacket</b>	TPE-O
<b>6 Protective conductor connection</b>	see 4 or Cu, tin plated with aluminium foil

## Checklist ELSR-W

### B + C Power Connection & End Termination

ELVB-SRA-25	Power connection, glued, Gland M25 x 1,5, PE	091A010
EL-ECW	Silicone termination cap, glued, transparent	09112W1
ELVB-SRV-N-L-W	Connection set, shrink-fit	0911116
El-Clic P/S	El-Clic P Fast connector with integrated cold lead El-Clic S Fast connector T-splice	09ClicP 09ClicS

### D Junction Boxes

ELAK-2	104 x 104 x 70 mm, polycarbonate, breakouts 7x M25, IP 66	0920030
ELAK-5	122 x 120 x 90 mm, polyester, 3 breakouts M25, IP 66	0920013
ELAK-5.1	130 x 130 x 75 mm, polycarbonate, breakouts 9x M20/M25, IP 66	0920002
ELAK-RS-T	150 x 125 mm, twin Pt100, 3 heaters incl. mounting stand, IP 65	0920059

### J Temperature Sensors

ELTF-PT.1	Pt100, 5 x 50 mm PVC 5 m	0650001
ELTF-PT.3	Pt100, 2 conductors, 5 x 50 mm, 3 m PTFE cable	0650003
ELTF-PT.3.1	Pt100, 3 conductors, 5 x 50 mm, 3 m PTFE cable	0650002

## Technical Information

<b>Maximum maintain temperature</b>	80 °C
<b>Maximum exposure temperature (de-energized)</b>	100 °C
<b>Nominal voltage</b>	230 V
<b>Bending radius, min.</b>	20 mm
<b>Installation temperature, min.</b>	- 20 °C

### Heating circuit lengths on the following conditions

- › 230 V nominal voltage
- › Delayed action circuit breakers (C-characteristic) with 80 % maximum load
- › Maximum 10 % line voltage drop on heating cable bus wire
- › Power connection to one heater end

### ELSR-W-...-2 output

(on insulated metallic pipes in accordance with EN 62395-1)

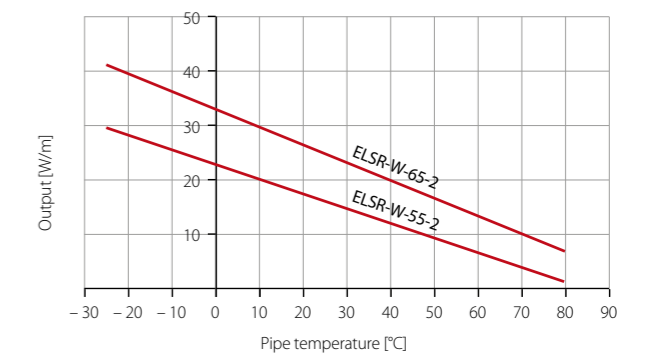

Switch-on temperature (°C)	Nominal cutout value (A)	Heating circuit length (m) for	
		ELSR-W-55-2	ELSR-W-65-2
10	10	70.0	45.5
	16	113.0	73.5
	20	131.0	92.0
	25	131.0	106.0
0	32	131.0	106.0
	10	63.0	41.5
	16	101.0	66.0
	20	123.5	83.0
-10	25	123.5	99.5
	32	123.5	99.5
	10	57.0	37.5
	16	91.0	60.0
-20	20	113.5	75.0
	25	117.0	94.0
	32	117.0	95.0
	10	52.0	34.0
-40	16	83.0	55.0
	20	104.0	69.5
	25	112.0	86.0
	32	112.0	90.5
	10	44.0	29.5
	16	70.0	48.0
	20	88.0	59.0
	25	103.0	74.0
	32	103.0	83.5

Type	Nominal output used for water supply lines	Dimensions approx. (mm)	Weight approx. (g/m)	Part No.
ELSR-W-55-2-AO	9 W/m at 55 °C	12.9 x 5.0	86	B0200360
ELSR-W-55-2-BO	9 W/m at 55 °C	12.9 x 5.0	105	B0200350
ELSR-W-65-2-AO	13 W/m at 65 °C	12.9 x 5.0	86	B0200455
ELSR-W-65-2-BO	13 W/m at 65 °C	12.9 x 5.0	105	B0200450

Type	Nominal output used with fat/oil lines	Dimensions approx. (mm)	Weight approx. (g/m)	Part No.
ELSR-W-65-2-AO	22 W/m at 40 °C	12.9 x 5.0	86	B0200455
ELSR-W-65-2-BO	22 W/m at 40 °C	12.9 x 5.0	105	B0200450

**At a Glance**

**Applications**

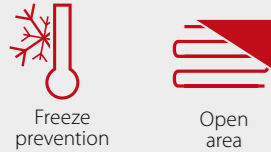

- › Parking garages entrances, exits
- › Helicopter landing sites
- › Concrete ramps
- › Stairs and footpaths

**Benefits**

- › Highly robust
- › Suited for hardest installing conditions
- › Flexible mounting
- › Radially and longitudinally waterproof
- › Outer jacket is strongly grouted with protective braid

**Approvals**



**Note**

- › Not suited for use in asphalt

# Type ELSR-Ramp

up to 100 °C

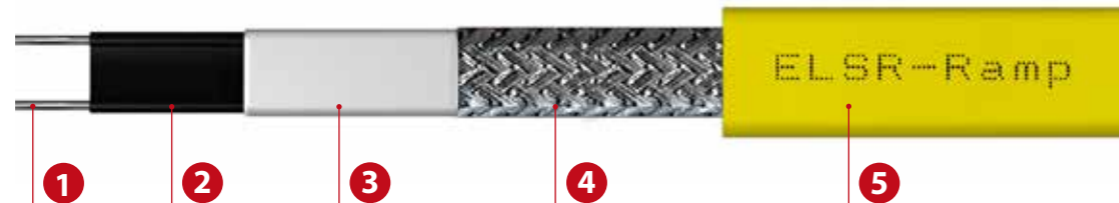

<b>1 Bus wire</b>	Nickel plated copper
<b>2 Self-regulating heating element</b>	
<b>3 Insulation</b>	
<b>4 Protection</b>	Protective braid (Cu, tin plated)
<b>5 Outer jacket</b>	TPE pressure-grouted with protective braid

## Checklist ELSR-Ramp

<b>B + C Power Connection &amp; End Termination</b>			
ELVB-SRV-Ramp	Connection set, shrink-fit		0911124
EL-ECRA	Silicone termination cap, glued, transparent		09112RA
<b>D Junction Boxes</b>			
ELAK-5	122 x 120 x 90 mm, polyester, 3 breakouts M25, IP 66		0920013
ELAK-5.1	130 x 130 x 75 mm, polycarbonate, breakouts 9x M20/M25, IP 66		0920002
<b>J Temperature Sensors</b>			
Sensor Set	Sensor set for ELSR-Ramp		TBA000202

## Technical Information

<b>Maximum maintain temperature</b>	80 °C
<b>Maximum exposure temperature (de-energized)</b>	100 °C
<b>Nominal voltage</b>	230 V
<b>Bending radius, min.</b>	50 mm
<b>Installation temperature, min.</b>	- 20 °C

**Heating circuit lengths on the following conditions**

- › 230 V nominal voltage
- › Delayed action circuit breakers (C-characteristic) with 80 % maximum load
- › Maximum 10 % line voltage drop on heating cable bus wire
- › Power connection to one heater end

Switch-on temperature (°C)	Nominal cutout value (A)	Heating circuit length (m) for	
		ELSR-Ramp	
-10	10	18.0	
	16	28.0	
	20	36.0	
	25	45.0	
	32	55.0	

Type	Nominal output	Dimensions approx. (mm)	Weight approx. (g/m)	Part No.
ELSR-Ramp	50 W/m at 10 °C	17,2 x 9,5	253	B02RAMP0
ELSR-Ramp	110 W/m at 5 °C in concrete	17,2 x 9,5	253	B02RAMP0

Heating circuit lengths may vary in specific installation situations. Please contact our engineers for more details.

**Electrical protection**

Maximum heating circuit length

- › According to local standards and regulations.
- › Take into account the supply lead conductor size and max. permitted voltage drop.
- › A higher voltage drop can occur at start-up of heating.

Power at start-up

- › According to local standards and regulations.
- › To determine the installed power with the electrical system designer, the nominal current of the series connected fuse or the current value at the system start-up temperature must be taken into account (e.g. 32 A for 55 m ELSR-Ramp (-10 °C).
- › Residual current device (RCD) 30 mA required, max. 500 m heating cable per RCD.

Remark

- › For the use of standard control cabinets, the maximum heating circuit length of 55 m at 32 A per heating circuit must not be exceeded.

## At a Glance

### Applications

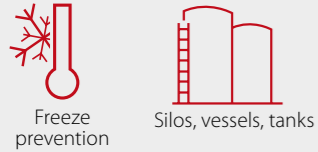

Freeze prevention  
Cryogenic Storage Tanks

### Benefits

- Highly robust
- Suitable for harsh installed environment
- Flexible mounting
- Waterproof

### Approvals



# Type ELSR-FHP up to 110 °C

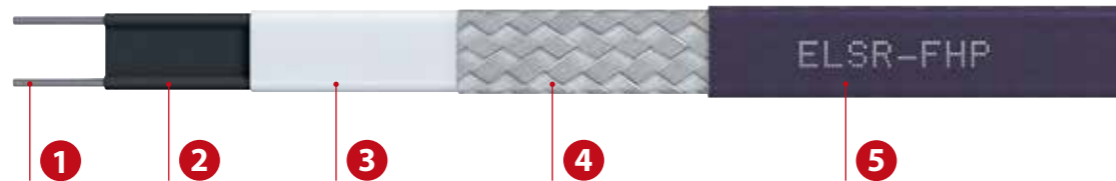

1	<b>Bus wire</b>	Nickel plated copper
2	<b>Self-regulating heating element</b>	
3	<b>Insulation</b>	
4	<b>Protection</b>	Protective braid (Cu, tin plated)
5	<b>Outer jacket</b>	Fluoropolymer

## Checklist ELSR-FHP

### B + C Power Connection & End Termination

EL-ECFHP	End termination kit for ELSR-FHP	09112F1
ELVB-SRA-25	Power connection, glued, Gland M25 x 1,5, PE	091A010

### D Junction Boxes

ELAK-2	104 x 104 x 70 mm, polycarbonate, breakouts 7x M25, IP 66	0920030
ELAK-5	122 x 120 x 90 mm, polyester, 3 breakouts M25, IP 66	0920013
ELAK-5.1	130 x 130 x 75 mm, polycarbonate, breakouts 9x M20/M25, IP 66	0920002

### J Temperature Sensors

ELTF-PT.1	Pt100, 5 x 50 mm PVC 5 m	0650001
ELTF-PT.3	Pt100, 2 conductors, 5 x 50 mm, 3 m PTFE cable	0650003
ELTF-PT.3.1	Pt100, 3 conductors, 5 x 50 mm, 3 m PTFE cable	0650002

## Technical Information

<b>Maximum maintain temperature</b>	80 °C (ELSR-FHP-38) 65 °C (ELSR-FHP-23)
<b>Maximum exposure temperature (de-energized)</b>	110 °C (ELSR-FHP-38) 80 °C (ELSR-FHP-23)
<b>Nominal voltage</b>	230 V
<b>Bending radius, min.</b>	50 mm
<b>Installation temperature, min.</b>	-45 °C

### Heating circuit lengths on the following conditions

- 230 V nominal voltage
- Delayed action circuit breakers (C-characteristic) with 80 % maximum load
- Maximum 10 % line voltage drop on heating cable bus wire
- Power connection to one heater end, in 25 mm/1" conduit

### ELSR-FHP-...-2 output

(in empty metallic protection pipes 1")

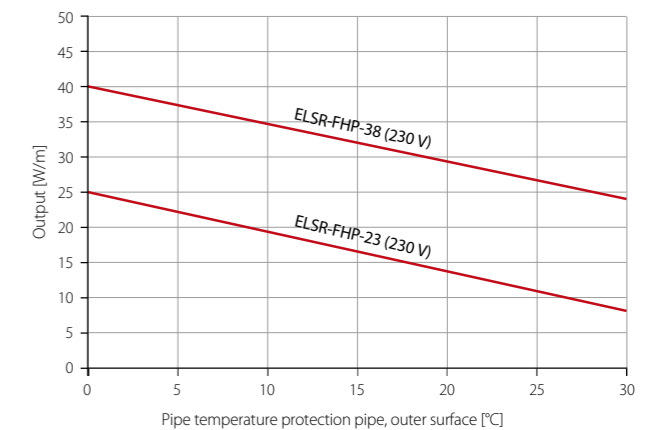

Switch-on temperature (°C)	Nominal cutout value (A)	Heating circuit length (m) for	
		ELSR-FHP-23	ELSR-FHP-38
-5	10	30.0	23.0
	16	48.5	36.5
	20	60.5	45.5
	25	75.5	57.5
	32	97.0	72.5
-15	40	121.0	91.5
	10	23.0	21.5
	16	37.0	34.5
	20	46.0	43.0
	25	57.5	54.0
	32	74.5	68.5
	40	92.0	85.5

Type	Nominal output	Dimensions approx. (mm)	Weight approx. (g/m)	Part No.
ELSR-FHP-23	23 W/m at 5 °C	14,0 x 5,5	155	B02FHP23
ELSR-FHP-38	38 W/m at 5 °C	14,0 x 5,5	155	B02FHP38

Heating circuit lengths may vary in specific installation situations. Please contact our engineers for more details.

## At a Glance

### Applications

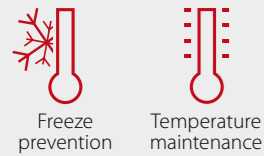

Valves, pumps Silos, vessels, tanks

- › Chemistry and Petrochemistry
- › Oil and Gas Industry
- › Power plants
- › Water and sanitation utilities

### Benefits

- › Seven nominal outputs
- › Moisture proof
- › Resistant to chemicals
- › Use in hazardous areas

### Design

## BOT

### Approvals



- › Trace Heater classification
  - II 2G Ex 60079-30-1 IIC Gb
  - II 2D Ex 60079-30-1 IIIC Db
- › System classification
  - II 2G Ex 60079-30-1 eb IIC T3 Gb
  - II 2D Ex 60079-30-1 tb IIIC T200°C Db
- › Certification
  - EPS IECEx 12.0004U
  - EPS IECEx 19.0006X
  - EPS 12 ATEX 1 429 U
  - EPS 19 ATEX 1013 X
- › Temperature class
  - T6 to T3
- › \* Use in Ex areas is permitted up to 180 °C

# Type ELSR-H

up to 210 °C\*

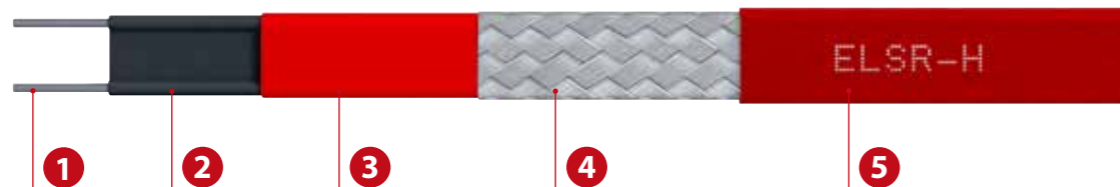

<b>1 Bus wire</b>	Nickel plated copper
<b>2 Self-regulating heating element</b>	
<b>3 Insulation</b>	Fluoropolymer
<b>4 Protection</b>	Protective braid (Cu, tin plated)
<b>5 Outer jacket</b>	Fluoropolymer

## Checklist ELSR-H

### B + C Power Connection & End Termination

EL-ECSH-Ex	Silicone termination cap, red, glued, with ex marking	0X81EH2
Ex-Con-SR	Ex connection sleeve Ø 36 x 210 mm 4J	0X81125
ELVB-SREx-25	Power connection, glued, Gland M25 x 1,5, PE, Ex e	0X81PA1
ELVB-SREx-IT	Power connection, glued, without gland	091AIT1
ELVB-SRAH-Ex-20	Power connection, glued, Gland M20, brass	0X81PHD
ELVB-SRV-H	Connection set, shrink-fit	0911117
ELVB-SRAH-25	Power connection, glued, Gland M25 x 1,5, PE	091A040

### D Junction Boxes

ELAK-Ex-3.7	122 x 120 x 90, 1-3 heaters, power supply lead max. 10 mm <sup>2</sup> , IP66	0X80057
Ex-it-R	Ø 150 x 125 mm, 3 heaters, 1 Pt100 power supply lead, incl. mounting stand, IP 65	0X80070
ELAK-Ex-3.5	122 x 120 x 90 mm, 1 heater, capillary thermostat, IP 66	0X80055
ELAK-5	122 x 120 x 90 mm, polyester, 3 breakouts M25, IP 66	0920013

### J Temperature Sensors

ELTF-PTEx.2	Pt100, 4 conductors, 3 m PTFE cable	0X70002
ELTF-PTEx.4	2x Pt100, 3 conductors, 3 m cold lead	0X70030
ELTF-PT.1	Pt100, 5 x 50 mm PVC 5 m	0650001
ELTF-PT.3	Pt100, 2 conductors, 5 x 50 mm, 3 m PTFE cable	0650003
ELTF-PT.3.1	Pt100, 3 conductors, 5 x 50 mm, 3 m PTFE cable	0650002

## Technical Information

<b>Maximum maintain temperature</b>	120 °C
<b>Maximum exposure temperature (de-energized)</b>	210 °C (max. 1000 h)
<b>Nominal voltage*</b>	230 V
<b>Bending radius, min.</b>	25 mm
<b>Installation temperature, min.</b>	-60 °C

\*Further power inputs on request

### Heating circuit lengths on the following conditions

- › 230 V nominal voltage
- › Delayed action circuit breakers (C-characteristic) with 80 % maximum load
- › Maximum 10 % line voltage drop on heating cable bus wire
- › Power connection to one heater end

Type	Nominal output	Dimensions approx. (mm)	Weight approx. (g/m)	Part No.
ELSR-H-10-2-BOT	10 W/m at 10 °C	12.4 x 5.0	120	B0221103
ELSR-H-15-2-BOT	15 W/m at 10 °C	12.4 x 5.0	120	B0221153
ELSR-H-20-2-BOT	20 W/m at 10 °C	12.4 x 5.0	120	B0221203
ELSR-H-30-2-BOT	30 W/m at 10 °C	12.4 x 5.0	120	B0221303
ELSR-H-45-2-BOT	45 W/m at 10 °C	12.4 x 5.0	120	B0221453
ELSR-H-60-2-BOT	60 W/m at 10 °C	12.4 x 5.0	120	B0221603
ELSR-H-75-2-BOT	75 W/m at 10 °C	12.4 x 5.0	120	B0221753

Switch-on temperature (°C)	Nominal cutout value (A)	Heating circuit length (m) for			
		ELSR-H-10-2	ELSR-H-15-2	ELSR-H-20-2	ELSR-H-30-2
10	16	193.0	158.0	122.0	82.0
	20	193.0	158.0	136.0	102.0
	25	193.0	158.0	136.0	111.0
	32	193.0	158.0	136.0	111.0
0	16	189.0	153.0	116.0	77.0
	20	189.0	153.0	132.0	97.0
	25	189.0	153.0	132.0	108.0
	32	189.0	153.0	132.0	108.0
-10	16	184.0	146.0	110.0	73.0
	20	184.0	148.5	129.0	92.0
	25	184.0	148.5	129.0	105.5
	32	184.0	148.5	129.0	105.5
-20	16	180.0	139.0	104.0	70.0
	20	180.0	145.0	125.5	87.0
	25	180.0	145.0	125.5	103.0
	32	180.0	145.0	125.5	103.0
-40	16	173.0	126.0	95.0	64.0
	20	173.0	138.0	119.0	80.0
	25	173.0	138.0	120.0	98.0
	32	173.0	138.0	120.0	98.0

### ELSR-H-...-2-BOT output

(on insulated metallic pipes according to 62395-1)

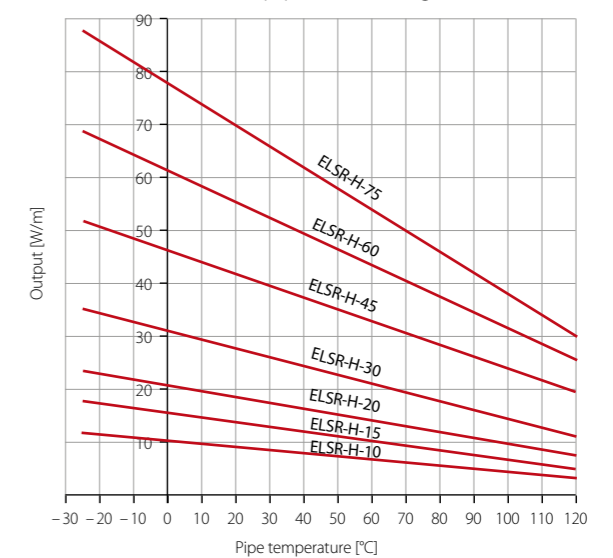

Switch-on temperature (°C)	Nominal cutout value (A)	Heating circuit length (m) for		
		ELSR-H-45-2	ELSR-H-60-2	ELSR-H-75-2
10	16	55.0	41.0	33.0
	20	68.0	51.0	41.5
	25	85.0	64.0	51.5
	32	91.0	79.0	66.0
0	16	52.0	39.0	30.0
	20	65.0	49.0	37.5
	25	81.0	61.0	47.0
	32	88.5	77.0	60.0
-10	16	50.0	37.0	28.5
	20	62.0	46.0	35.5
	25	77.0	58.0	44.5
	32	86.5	70.0	57.0
-20	16	47.0	36.0	26.5
	20	59.0	44.0	33.5
	25	74.0	56.0	41.5
	32	84.5	67.0	53.5
-40	16	43.0	33.0	23.5
	20	54.0	41.0	29.0
	25	68.0	51.0	36.5
	32	81.0	61.0	46.5



## At a Glance

### Applications

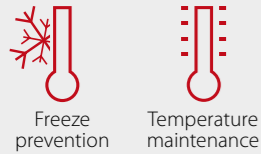

Valves, pumps Silos, vessels, tanks

- › Chemistry and Petrochemistry
- › Oil and Gas Industry
- › Power plants

### Benefits

- › Temperature classification T3\*
  - › Five nominal outputs
  - › Moisture proof
  - › Resistant to chemicals
  - › Use in hazardous areas
- \*Except for 90 W/m: T2

### Design

## BOT

### Approvals



- › Trace Heater classification
  - II 2G Ex 60079-30-1 IIC Gb
  - II 2D Ex 60079-30-1 IIIC Db
- › System classification
  - II 2G Ex 60079-30-1 eb IIC T2 Gb
  - II 2D Ex 60079-30-1 tb IIIC T220°C Db
- › Certification
  - EPS IECEx 18.0019U
  - EPS IECEx 18.0014X
  - EPS 18 ATEX 1 028 U
  - EPS 18 ATEX 1 020 X
- › Temperature class
  - T3/T2

# Type ELSR-SH

## up to 250 °C

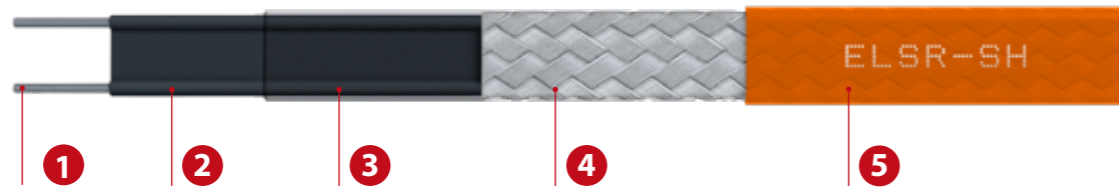

<b>1 Bus wire</b>	Nickel plated copper
<b>2 Self-regulating heating element</b>	
<b>3 Insulation</b>	Fluoropolymer
<b>4 Protection</b>	Protective braid (Cu, tin plated)
<b>5 Outer jacket</b>	Fluoropolymer

## Checklist ELSR-SH

### B + C Power Connection & End Termination

ELVB-SREx-25	Power connection, glued, Gland M25 x 1,5, PE, Ex e	0X81PA1
ELVB-SREx-IT	Power connection, glued, without gland	091AIT1
EL-ECSh-Ex	Silicone termination cap, red, glued, with ex marking	0X81EH2
ELVB-SRASH-Ex-20	Power connection, glued, Gland M20, Ex d	0X81PSD
ELVB-SRAH-25	Power connection, glued, Gland M25 x 1,5, PE	091A040

### D Junction Boxes

ELAK-Ex-3.7	122 x 120 x 90, 1-3 heaters, power supply lead max. 10 mm <sup>2</sup> , IP66	0X80057
Ex-it-R	∅ 150 x 125 mm, 3 heaters, 1 Pt100 power supply lead, incl. mounting stand, IP 65	0X80070
ELAK-Ex-3.5	122 x 120 x 90 mm, 1 heater, capillary thermostat, IP 66	0X80055
ELAK-5	122 x 120 x 90 mm, polyester, 3 breakouts M25, IP 66	0920013

### J Temperature Sensors

ELTF-PTEx.2	Pt100, 4 conductors, 3 m PTFE cable	0X70002
ELTF-PTEx.4	2x Pt100, 3 conductors, 3 m cold lead	0X70030
ELTF-PT.1	Pt100, 5 x 50 mm PVC 5 m	0650001
ELTF-PT.3	Pt100, 2 conductors, 5 x 50 mm, 3 m PTFE cable	0650003
ELTF-PT.3.1	Pt100, 3 conductors, 5 x 50 mm, 3 m PTFE cable	0650002

## Technical Information

<b>Maximum maintain temperature</b>	165 °C
<b>Maximum exposure temperature (de-energized)</b>	250 °C
<b>Nominal voltage</b>	230 V
<b>Bending radius, min.</b>	25 mm
<b>Installation temperature, min.</b>	-60 °C

### Heating circuit lengths on the following conditions

- › 230 V nominal voltage
- › Delayed action circuit breakers (C-characteristic) with 100 % load
- › Maximum 10 % line voltage drop on heating cable bus wire
- › Power connection to one heater end

Type	Nominal output	Dimensions approx. (mm)	Weight approx. (g/m)	Part No.
ELSR-SH-15-2-BOT	15 W/m at 10 °C	14 x 5,4	146	B0226153
ELSR-SH-35-2-BOT	35 W/m at 10 °C	14 x 5,4	146	B0226353
ELSR-SH-45-2-BOT	45 W/m at 10 °C	14 x 5,4	146	B0226453
ELSR-SH-75-2-BOT	75 W/m at 10 °C	14 x 5,4	146	B0226753
ELSR-SH-90-2-BOT	90 W/m at 10 °C	14 x 5,4	146	B0226903

### ELSR-SH-...-2-BOT output

(on insulated metallic pipes according to 62395-1)

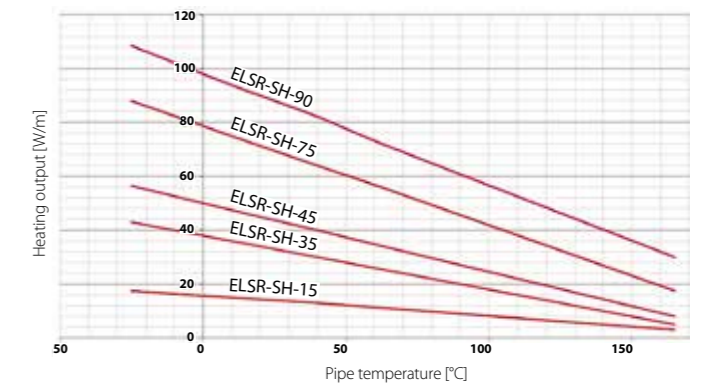

Switch-on temperature (°C)	Nominal cutout value (A)	Heating circuit length (m) for ELSR-SH				
		15-2 BOT	35-2 BOT	45-2 BOT	75-2 BOT	90-2 BOT
10	10	113	50.0	36.25	18.75	17.0
	16	172	80.0	58.0	30.0	27.0
	20	172	99.0	72.5	37.5	34.0
	25	172	107.5	90.625	47.0	42.5
	32	172	107.5	98.0	60.0	54.0
0	10	106	47.0	34.5	17.75	16.0
	16	169	75.0	55.0	28.5	26.0
	20	172	94.0	69.0	35.5	32.0
	25	172	107.5	86.25	44.5	40.0
	32	172	107.5	98.0	57.0	52.0
-10	10	99	44.0	32.5	16.5	15.5
	16	159	71.0	52.0	26.5	25.0
	20	172	89.0	65.0	33.0	31.0
	25	172	107.5	81.25	41.25	38.75
	32	172	107.5	98.0	53.0	50.0
40	172	107.5	98.0	66.0	62.0	

Switch-on temperature (°C)	Nominal cutout value (A)	Heating circuit length (m) for ELSR-SH				
		15-2 BOT	35-2 BOT	45-2 BOT	75-2 BOT	90-2 BOT
-20	10	94	42.0	30.0	15.5	15.0
	16	150	67.0	48.0	25.0	24.0
	20	172	84.0	60.0	31.0	30.0
	25	172	105.0	75.0	38.75	37.5
	32	172	107.5	96.0	50.0	48.0
-30	10	89	40.0	27.5	15.0	14.5
	16	142.5	64.0	44.0	24.0	23.0
	20	172	80.0	55.0	30.0	29.0
	25	172	100.0	68.75	37.5	36.25
	32	172	107.5	88.0	48.0	46.0
-40	10	84	38.0	25.0	14.0	14.0
	16	135	61.0	40.0	22.5	22.0
	20	169	76.0	50.0	28.0	28.0
	25	172	95.0	62.5	35.0	35.0
	32	172	107.5	80.0	45.0	44.0
40	172	107.5	98.0	56.0	56.0	

## At a Glance

### Applications

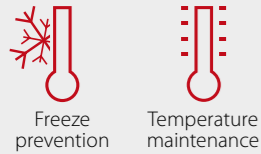

Valves, pumps Silos, vessels, tanks

- › Chemistry and Petrochemistry
- › Oil and Gas Industry
- › Power plants

### Benefits

- › Temperature classification T3\*
  - › Five nominal outputs
  - › Moisture proof
  - › Resistant to chemicals
  - › Use in hazardous areas
- \*Except for 75 W/m: T2

### Design

**BOT**

### Approvals



- › Trace Heater classification
  - II 2G Ex 60079-30-1 IIC Gb
  - II 2D Ex 60079-30-1 IIIC Db
- › System classification
  - II 2G Ex eb IIC T3 Gb
  - II 2D Ex tb IIIC T200°C Db
- › Certification
  - EPS 17 ATEX 1 169 X
  - EPS IECEx 17.0064X
  - CML20ATEX3171
- › Temperature class
  - T3/T2

# Type ELSR-SHH

## up to 250 °C

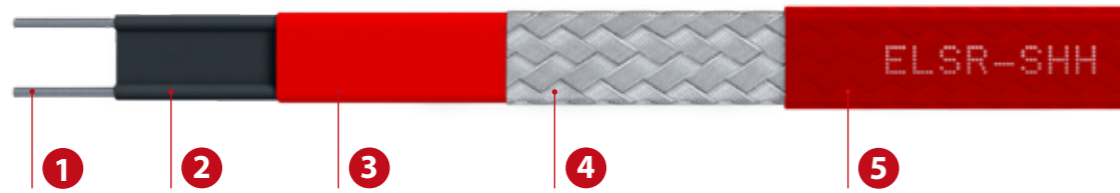

<b>1 Bus wire</b>	Nickel plated copper
<b>2 Self-regulating heating element</b>	
<b>3 Insulation</b>	
<b>4 Protection</b>	Protective braid (Cu, tin plated)
<b>5 Outer jacket</b>	TPE-O, Fluoropolymer

## Checklist ELSR-SHH

B + C Power Connection & End Termination			
	ELVB-SREx-25	Power connection, glued, Gland M25 x 1,5, PE, Ex e	0X81PA1
	EL-ECSh-Ex	Silicone termination cap, red, glued, with ex marking	0X81EH2
D Junction Boxes			
	ELAK-Ex-3.7	122 x 120 x 90, 1-3 heaters, power supply lead max. 10 mm <sup>2</sup> , IP66	0X80057
	Ex-it-R	ø 150 x 125 mm, 3 heaters, 1 Pt100 power supply lead, incl. mounting stand, IP 65	0X80070
	ELAK-Ex-3.5	122 x 120 x 90 mm, 1 heater, capillary thermostat, IP 66	0X80055
	ELAK-5	122 x 120 x 90 mm, polyester, 3 breakouts M25, IP 66	0920013
J Temperature Sensors			
	ELTF-PTEx.2	Pt100, 4 conductors, 3 m PTFE cable	0X70002
	ELTF-PTEx.4	2x Pt100, 3 conductors, 3 m cold lead	0X70030
	ELTF-PT.1	Pt100, 5 x 50 mm PVC 5 m	0650001
	ELTF-PT.3	Pt100, 2 conductors, 5 x 50 mm, 3 m PTFE cable	0650003
	ELTF-PT.3.1	Pt100, 3 conductors, 5 x 50 mm, 3 m PTFE cable	0650002

## Technical Information

Maximum maintain temperature	250 °C
Maximum exposure temperature (de-energized)	250 °C
Nominal voltage	230 V
Bending radius, min.	35 mm
Installation temperature, min.	-40 °C

### Heating circuit lengths on the following conditions

- › 230 V nominal voltage
- › Delayed action circuit breakers (C-characteristic) with 80 % maximum load
- › Maximum 10 % line voltage drop on heating cable bus wire
- › Power connection to one heater end

### ELSR-SHH-...-2-BOT output

(on insulated metallic pipes according to 62395-1)

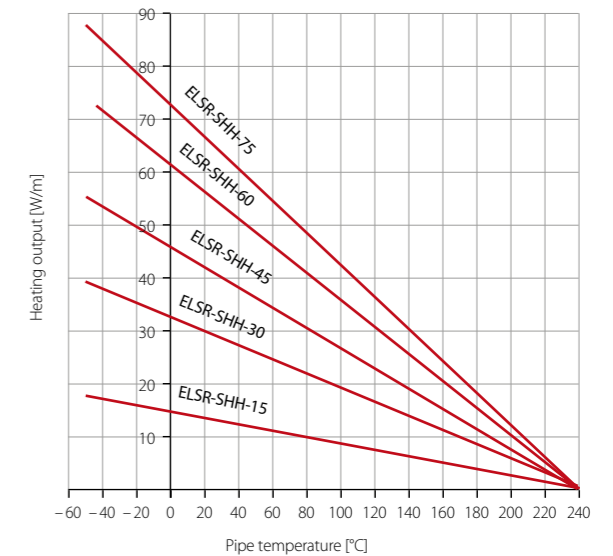

















Switch-on temperature (°C)	Nominal cutout value (A)	Heating circuit length (m) for ELSR-SHH				
		15-2	30-2	45-2	60-2	75-2
10	10	76.0	52.0	38.0	24.0	14.0
	16	122.0	82.0	62.0	38.0	24.0
	20	154.0	102.0	76.0	46.0	28.0
	32	154.0	108.0	88.0	76.0	46.0
0	10	70.0	46.0	32.0	18.0	12.0
	16	112.0	74.0	52.0	30.0	18.0
	20	140.0	92.0	66.0	36.0	22.0
	32	146.0	104.0	84.0	58.0	36.0
-20	10	62.0	40.0	24.0	12.0	8.0
	16	98.5	66.0	38.0	20.0	12.0
	20	122.5	82.0	46.0	26.0	16.0
	32	138.5	98.0	76.0	42.0	24.0
-40	10	52.0	30.0	14.0	8.0	4.0
	16	82.0	50.0	24.0	12.0	8.0
	20	102.0	62.0	28.0	16.0	10.0
	32	126.0	88.0	46.0	24.0	14.0

Type	Nominal output	Dimensions approx. (mm)	Weight approx. (g/m)	Part No.
ELSR-SHH-15-2-BOT	15 W/m at 10 °C	12,1 x 5,4	146	BOHH1153
ELSR-SHH-30-2-BOT	30 W/m at 10 °C	12,1 x 5,4	146	BOHH1303
ELSR-SHH-45-2-BOT	45 W/m at 10 °C	12,1 x 5,4	146	BOHH1453
ELSR-SHH-60-2-BOT	60 W/m at 10 °C	12,1 x 5,4	146	BOHH1603
ELSR-SHH-75-2-BOT	75 W/m at 10 °C	12,1 x 5,4	146	BOHH1753

# Accessories







## Self-Regulating Trace Heater System

### B\* – Power Connection Kits

	Type	suitable for ELSR		Description	Ambient temperature	Part No.
	EI-Clic P	-N, -LS, -W		Fast connector with integrated cold lead	-40 °C to +100 °C	09ClicP
	EI-Clic S	-N, -LS, -W		Fast connector T-splice	-40 °C to +100 °C	09ClicS
	ELVB-SRA-25	-N, -LS, -W, -FHP		Power connection, glued, Gland M25 x 1,5, PE	+100 °C	091A010
	ELVB-SRAH-25	-H, -SH		Power connection, glued, Gland M25 x 1,5, PE	+100 °C	091A040
	ELVB-SRAM-25	-M		Power connection, shrink-fit, Gland M25 x 1,5, PE	+100 °C	091A015
	ELVB-SRAR-25	-R		Power connection, shrink-fit, Gland M25 x 1,5, PE	+100 °C	091A020
	ELBV-BF	-M-AF/BF		Power connection/termination set, suitable for drinking water KTW approved	+65 °C	0911022
	ELVB-SRAN-Ex-20	-N, -FHP	●	Power connection, glued, Gland M20, brass, Ex d	-60 °C to +180 °C	0X81PND
	ELVB-SRAL-Ex-20	-LS	●	Power connection, glued, Gland M20, brass	-60 °C to +180 °C	0X81PLD
	ELVB-SRAH-Ex-20	-H, -SH, -SHH	●	Power connection, glued, Gland M20, brass	-60 °C to +180 °C	0X81PHD
	ELVB-SRASH-Ex-20	-SH	●	Power connection, glued, Gland M20, Ex d	-60 °C to +180 °C	0X81PSD
	ELVB-SREx-25	-N, -LS, -H, -FHP	●	Power connection, glued, Gland M25 x 1,5, PE, Ex e	-25 °C to +70 °C	0X81PA1
	ELVB-SREx-IT	-N, -H	●	Power connection, glued, without gland	-60 °C to +180 °C	091AIT1
	ELVB-SRV-N-L-W	-N, -LS, -W		Connection set, shrink-fit	+65 °C	0911116
	ELVB-SRV-M	-M, -R		Connection set, shrink-fit	+65 °C	0911122

\*Category letters refer to the Checklists on p. 9 and the respective datasheet.













### B\* – Power Connection Kits

	Type	suitable for ELSR		Description	Ambient temperature	Part No.
	ELVB-SRV-H	-H		Connection set, shrink-fit	+100 °C	0911117
	ELVB-SRV-Ramp	-Ramp		Connection set, shrink-fit	+100 °C	0911124
	Ex-Con-SR	-N, -LS, -H	●	Ex connection sleeve Ø 36 x 210 mm 4J	-32 °C to +200 °C	0X81125
	ELVB-70	-M-AF/BF		Cable gland MS 3/4", brass, approved for drinking water	+65 °C	0911703
	ELVB-71	-M-AF/BF		Y-connector 32 mm, brass, approved for drinking water	+65 °C	0911704
	M20	-N, -H	●	Ex-d cable gland, brass, fits Y-connector	-60 to +180 °C	2572020003







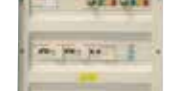
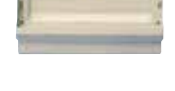
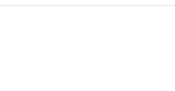
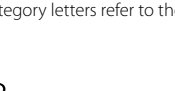
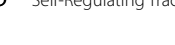

# Accessories

## Self-Regulating Trace Heater System

### C\* – End Termination Kits

	Typ	geeignet für ELSR		Beschreibung	Umgebungs-temperatur	Art.-Nr.
	EL-ECSH-ex	-H, -SH, -SHH	●	Silicone termination cap red, glued, with ex marking	-60 °C to +250 °C	0X81EH2
	EL-ECL	-LS		Silicone termination cap transparent, glued	-45 °C to +85 °C	09112L1
	EL-ECL-ex	-LS	●	Silicone termination cap black, glued, with ex marking	-60 °C to +135 °C	0X81EL1
	EL-ECN-ex	-N	●	Silicone termination cap black, glued, with ex marking	-60 °C to +135 °C	0X81EN1
	EL-ECN	-N		Silicone termination cap transparent, glued	-45 °C to +85 °C	09112N1
	EL-ECFHP	-FHP		Silicone termination cap transparent, glued	-45 °C to +85 °C	09112F1
	EL-ECM	-M, -R		Silicone termination cap transparent, glued	-45 °C to +85 °C	09112M1
	EL-ECMF	-M-AF/BF		Silicone termination cap transparent, glued	-45 °C to +85 °C	09112MF
	EL-ECW	-W		Silicone termination cap transparent, glued	-45 °C to +85 °C	09112W1
	EL-ECRA	-Ramp		Silicone termination cap transparent, glued	-45 °C to +85 °C	09112RA
	Ex-It-S	-N, -LS, -H	●	Heating circuit extension with blind cap, IP65	-60 °C to +55 °C	0X8ITS0
	Ex-It-L	-N, -LS, -H	●	Heating circuit termination with LED signal light, IP65	-60 °C to +55 °C	0X8ITLG
	ELHKV-E1-1	all		Heating circuit manifold, 1 circuit		0640001
	ELHKV-E1-2	all		Heating circuit manifold, 2 circuits		0640002
	ELHKV-St-3	all		Heating circuit manifold, 3 circuits		0640003
	ELHKV-St-6	all		Heating circuit manifold, 6 circuits		0640006
	ELHKV-St-9	all		Heating circuit manifold, 9 circuits		0640009
	ELHKV-St-12	all		Heating circuit manifold, 12 circuits		0640012

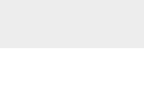
### D\* – Junction Boxes



	Type	suitable for ELSR		Description	Ambient temperature	Part No.
	ELAK-2	all		104 x 104 x 70 mm, polycarbonate, IP 66, up to 3 heaters, cable gland 1x M25, stamp 7x M20/M25	-40 °C to +70 °C	0920030
	ELAK-5	all		122 x 120 x 90 mm, polyester, IP 66, up to 2 heaters, cable gland 3x M25	-40 °C to +90 °C	0920013
	ELAK-5.1	all		130 x 130 x 75 mm, polycarbonate, IP 66, up to 3 heaters, stamp 9x M20/M25	-35 °C to +80 °C	0920002
	ELAK-5.7	all		122 x 120 x 90 mm, polyester, grey, IP 65, up to 3 heaters, cable gland 1x M25, holes 3x M25	-40 °C to +90 °C	0920014
	ELAK-5.8	all Pt100 temperature sensors		122 x 120 x 90 mm, polyester, grey, IP 65, cable gland 2x M25 1x M16, holes 1x M16	-40 °C to +90 °C	0920015
	ELAK-Ex-3.5	-N, -LS, -H, -SH, -SHH	●	122 x 120 x 90 mm, 1 heater, capillary thermostat, IP 66, cable gland 1x M25, holes 2x M25	-40 °C to +60 °C	0X80055
	ELAK-Ex-3.7	-N, -LS, -H, -SH, -SHH	●	122 x 120 x 90, 1-3 heaters, power supply lead max. 10 mm <sup>2</sup> , IP66, cable gland 1x M25 2x M12	-40 °C to +60 °C	0X80057
	ELAK-Ex-3.8	all Pt100 temperature sensors	●	122 x 120 x 90, 1-2 Pt100, max. 2,5 mm <sup>2</sup> , IP66, cable gland 1x M25 2x M12	-40 °C to +60 °C	0X80058
	ELAK-Ex-R5	all	●	∅ 150 x 125 mm, 1 heater, IP 65, cable gland 1x M25, 1x M20, holes 1x M25, 1x M16	-40 °C to +60 °C	0X80075
	ELAK-Ex-R7	-N, -LS, -H, -SH, -SHH	●	∅ 150 x 125 mm, 1-3 heaters, power supply lead max. 6 mm <sup>2</sup> , IP 65, cable gland 1x M25, holes 3x M25	-40 °C to +50 °C	0X80077
	ELAK-Ex-R8	all Pt100 temperature sensors	●	∅ 150 x 125 mm, 1-2 Pt100, max. 2,5 mm <sup>2</sup> , IP 65, cable gland 1x M25 2x M12	-40 °C to +50 °C	0X80078

\*Category letters refer to the Checklists on p. 9 and the respective datasheet.



# Accessories

## Self-Regulating Trace Heater System





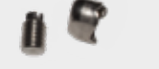







### D\* – Junction Boxes

	Type	suitable for ELSR	Ex	Description	Ambient temperature	Part No.
	Ex-it-R	-N, -LS, -H, -SH, -SHH	●	∅ 150 x 125 mm, 3 heaters, 1 Pt100 power supply lead, incl. mounting stand, IP 65, cable gland 1x M25	-20 °C to +50 °C	0X80070
	Ex-it-R-T	-N, -LS, -H, -SH, -SHH	●	∅ 150 x 125 mm, 3 heaters, incl. mounting stand, IP 65, cable gland 1x M25	-20 °C to +50 °C	0X80082
	Ex-it-R-Pt	all Pt100 temperature sensors	●	150 x 125 mm, 1 Pt100, 1 sensor cable, incl. mounting stand, IP 65, cable gland 1x M25	-20 °C to +50 °C	0X80092
	ELAK-RS-T	-N, -LS, -W		150 x 125 mm, twin Pt100, 3 heaters incl. mounting stand, IP 65, cable gland 1x M25	-45 °C to +50 °C	0920059
	ELAK-RS	-N, -LS, -H, -SH, -SHH		150 x 125 mm, incl. mounting stand, IP 65, cable gland 1x M25, holes 1x M25 1x M20	-45 °C to +50 °C	0920050

### E\* – Pipe Mounting Bracket

	Type	suitable for	Ex	Description	Part No.
	ELB-13V1	all	●	Tightening strap, threaded, 11 mm, 30 m, Mat. 1.4301	2723001010
	ELB-13V2	all	●	Turnbuckle 1.4301 (selling unit 10 pieces), Mat. 1.4301	0930042
	ELB-15.04	all	●	Hose clamp, 25 - 40 mm, Mat. 1.4301	2723001025
	ELB-15.06	all	●	Hose clamp, 40 x 60mm, Mat. 1.4301	2723001040
	ELB-15.09	all	●	Hose clamp 40-90 mm (DN 25-65), Mat. 1.4301	2723040090
	ELB-15.11	all	●	Hose clamp, 50 - 110 mm, Mat. 1.4301	2723050110

### E\* – Pipe Mounting Bracket







	Type	suitable for	Ex	Description	Part No.
	ELB-15.288	all	●	Hose clamp, 60 - 288 mm, Mat. 1.4301	2723060288
	ELB-15.650	all	●	Hose clamp, 60 - 650 mm, Mat. 1.4301	2723060650
	ELB-18	all	●	Assembly and fastening plate for gutters, 290 x 30 x 1,5 mm, Mat. 1.4301	0930040
	ELB-20	all	●	Mounting bracket 90° for downpipes, Mat. 1.4301	0930043
	ELB-21	all	●	Mounting profile for gutters, Mat. 1.4301, 290 mm long	0930044
	ELB-22	all	●	PE mounting profile for trace heaters, spacing 25 mm	0942000
	ELMW-5	ELAK-2	●	Support bracket, 85 x 85 mm, Mat. 1.4301	0941005
	ELMW-9	ELAK-5, ELAK-Ex 3, ELth-1, -BTB, -BSTW	●	Support bracket, 122 x 120 mm, Mat. 1.4301	0941009
	ELMW-11	ELTC-05, -14, -15 ELAK-5.1	●	Support bracket, 130 x 130 mm, Mat. 1.4301	0941011
	ELMW-Ex-Box	Ex-Box REG / Ex-Box-LIM	●	Support bracket, 185 x 185 mm, Mat. 1.4301	0941072
	ELMW-CT	EL-CT...	●	Support bracket, Mat. 1.4301	0941025
	ELMW-GP1	ELT-GP 1	●	Support bracket 175 x 125 mm, Mat. 1.4301	0941020
	EL-VSB 300	all	●	Variable support bracket, height adjustable from 180 - 300 mm, Mat. 1.4301	0941085
	EL-VSB 400	all	●	Variable support bracket, height adjustable from 280 - 400 mm, Mat. 1.4301	0941086

\*Category letters refer to the Checklists on p. 9 and the respective datasheet.



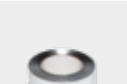

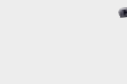

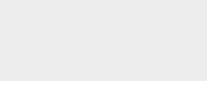
# Accessories

## Self-Regulating Trace Heater System

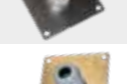



### F\* – Fasteners and Self-Adhesive Tapes, Foils

	Type	suitable for ELSR	Ex	Description	max. Operating temperature	Part No.
	ELB-02	all	●	Adhesive tape, glass silk 20 m x 12 mm	+140 °C	2486800125
	ELB-02A	all	●	Adhesive tape, glass silk 30 m x 12 mm	+180 °C	2486800126
	ELB-02B	alle	●	Adhesive tape, glass silk 50 m x 12 mm	+180 °C	2486800130
	ELB-06	all	●	Aluminium foil, 50 m x 75 mm, self-adhesive	-40 °C to +140 °C	0942200
	ELB-06D	all	●	Aluminium foil 100 m x 75 mm, self-adhesive	-40 °C to +140 °C	2701900076
	ELB-06C	all	●	Aluminium foil 50 m x 50 mm, reinforcement grid, -40 ... +80 °C	-40 °C to +130 °C	2701900051
	ELB-06E	all	●	Aluminium foil 50 m x 536 mm, self-adhesive	+150 °C	2701900500
	ELB-16.10	all	●	Plastic tightening straps 100 x 2,5 mm, black, UV resistant, selling unit = 100 pcs.	+85 °C	2796000001
	ELB-16.20	all	●	Plastic tightening straps 200 x 3,6 mm, black, UV resistant, selling unit = 100 pcs.	+85 °C	2796000002
	ELB-16.36	all	●	Plastic tightening straps 360 x 4,8 mm, black, UV resistant, selling unit = 100 pcs.	+85 °C	2796000003

### G\* – Insulation Bushing

	Type	suitable for ELSR	Ex	Description	Part No.
	ELISD-1.12	all temperature sensors	●	3,5 - 7 mm, 70 x 70 mm, 1 x M12 x 1,5	0921011
	ELISD-1.16	all temperature sensors	●	Cover plate, aluminium, 4,5 - 10 mm, 70 x 70 mm, 1 x M16	0921015
	ELISD-1.20	all connections	●	7 - 13 mm, 70 x 70 mm, 1 x M20	0921019
	ELISD-1.25	all connections	●	9 - 17 mm, 70 x 70 mm, 1 x M25	0921023
	ELISD-R1	-N, -LS, -W	●	Cover plate, aluminium, 70 x 70 mm	0921035
	ELISD-R5	-M, -R	●	Insulation bushing	0921101
	ELISD-R4	-H, -SH, -SHH	●	Cover plate, aluminium, 70 x 70 mm	0921047

### H\* – Warning Signs















	Type	suitable for ELSR	Ex	Description	Part No.
	EL-WS01D	all	●	German "Elektrische Begleitheizung"	2986900002
	EL-WS01E	all	●	English "Electrical Heat Tracing"	2986900012
	EL-WS01F	all	●	French "Traçage Electrique"	2986900032
	EL-WS01R	all	●	Russian "Electrical Heat Tracing"	2986900013
	EL-WS01I	all	●	Italian "Electrical Heat Tracing"	2986900089

\*Category letters refer to the Checklists on p. 9 and the respective datasheet.

# Accessories







## Self-Regulating Trace Heater System

### I\* – Temperature Controllers





	Type	suitable for ELSR	Ex	Description	Operating temperature	Part No.
	ELTC-05	all		Pt100, 1 relay, 230 V Frostcontrol, +3 °C, 1 load relay	-30 °C to +50 °C	0610002
	ELTC-14	all		Pt100, 2 conductors, 3 conductors, 0 °C to + 390 °C, without Pt100	-25 °C to +55 °C	0620000
	ELTC-14P	all		Pt100, 2 conductors, 3 conductors	-30 °C to +60 °C	0620010
	ELTC-15	all		Pt100, 2 conductors, 3 conductors temperature controller to 999 °C, with ramp function	-25 °C to +55 °C	0621500
	ELTC-21	all		Pt100, 2 conductors, 3 conductors 0 °C bis 400 °C, rail-mounted 230 VAC	-25 °C to +55 °C	0610093
	ELTC-22	all		Pt100, 2 conductors, 3 conductors 0 °C to 400 °C, rail-mounted 24 VDC	-25 °C to +55 °C	0610094
	ELTC-24P	all		Pt100, 2 conductors, 3 conductors	-30 °C to +60 °C	0620011
	ELTC-41	all		Pt100, 2-2 conductors, 3 conductors 90 to 260 V AC	-25 °C to +55 °C	0620041
	ELTC-42	all		2 x Pt100, 2 conductors, 3 conductors microprocessor, front assembly	-25 °C to +55 °C	0620042
	ELTC-W	-W		Water Comfort System, power controller	-25 °C to +65 °C	0630000
	Ex-Box REG/DIS	all	●	Electronic controller with display, Pt100, 2-Leiter, 3-Leiter	-30 °C to +60 °C	0X60020
	Ex-Box REG/LED	all	●	Electronic controller with LED, Pt100, 2 conductors, 3 conductors	-30 °C to +60 °C	0X60021
	Ex-Box LIM/LED	all	●	Electronic controller with LED, Pt100, 2 conductors, 3 conductors	-30 °C to +60 °C	0X60023
	Ex-Box LIM/DIS	all	●	Electronic controller with Display Pt100, 2 conductors, 3 conductors	-30 °C to +60 °C	0X60024

\*Category letters refer to the Checklists on p. 9 and the respective datasheet.

### I\* – Temperature Controllers

	Type	suitable for ELSR	Ex	Description	Operating temperature	Part No.
	ISD-1	all		Ice and snow sensor for gutters, including sensor devices	-10 °C to +50 °C	0620623
	ISD-1.1	all		Ice and snow sensor for gutters, including sensor devices	-10 °C to +50 °C	0620624
	EL-CT 50	all	●	Capillary thermostat	-30 °C to +50 °C	0X63050
	EL-CT 30	all	●	Capillary thermostat	-30 °C to +50 °C	0X63030
	Ex-TC/A	alle	●	Electronic Controller with Alarm Function	-40 °C to +50 °C	0X60103 0X60101
	Ex-TC/AL	alle	●	Electronic Controller and Limiter with Alarm Function	-40 °C to +50 °C	0X60123 0X60121
	Ex-TC/M	alle	●	Electronic Controller with Modbus communication	-40 °C to +50 °C	0X60133 0X60131

### J\* – Temperature Sensors

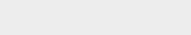
	Type	suitable for ELSR	Ex	Description	Operating temperature	Part No.
	ELTF-PT.1	all		Pt100, 5 x 50 mm PVC 5 m	-30 °C to +80 °C	0650001
	ELTF-PT.3	all		Pt100, 2 conductors, 5 x 50 mm, 3 m PTFE cable	-50 °C to +250 °C	0650003
	ELTF-PT.3.1	all		Pt100, 3 conductors, 5 x 50 mm, 3 m PTFE cable	-50 °C to +250 °C	0650002
	ELTF-PTEEx.2	all	●	Pt100, 4 conductors, 3 m PTFE cable	-45 °C to +235 °C	0X70002
	ELTF-PTEEx.4	all	●	2x Pt100, 3 conductors, 3 m cold lead	-45 °C to +235 °C	0X70030
	ISD-STH	all		Temperature- / moisture sensor for gutters	-40 °C to +85 °C	TBC0001

# Applications

## Self-Regulating Trace Heaters

### in Hazardous Areas

<b>A Trace Heater</b>	ELSR-N, -LS, -FHP, -H, -SH, -SHH
<b>B Connection Kit</b>	e. g. Ex-Con-SR (or ELVB...Ex...)
<b>C End Termination Kit</b>	EL-EC...ex
<b>D Junction Box</b>	e. g. Ex-it-R (or ELAK-Ex...)
<b>E Pipe Mounting Fitting</b>	ELMW-..., ELB-...
<b>F Fasteners and Self-adhesive Tapes, Foils</b>	ELB-...
<b>G Insulation Bushing</b>	ELISD-...
<b>H Warning Sign</b>	EL-WS...
<b>I Temperature Controller</b>	e. g. Ex-Box Temperature Controller
<b>J Temperature Sensor</b>	

### in Non-Hazardous Areas

<b>A Trace Heater</b>	ELSR-N, -LS, - M, -M-AF/BF, -R, -W, - Ramp, -FHP, -H, -SH, SHH
<b>B Connection Kit</b>	e. g. EI-Clic-P (or ELVB-...)
<b>C End Termination Kit</b>	EL-EC...
<b>D Junction Box</b>	e. g. ELAK-RS
<b>E Pipe Mounting Fitting</b>	ELMW-..., ELB-...
<b>F Fasteners and Self-adhesive Tapes, Foils</b>	ELB-...
<b>G Insulation Bushing</b>	ELISD-...
<b>H Warning Sign</b>	e. g. ELTC-14 Temperature Controller
<b>I Temperature Controller</b>	ELTF-...
<b>J Temperature Sensor</b>	

This is just a schematic overview, not an installation instruction. For detailed information, please contact our engineers.

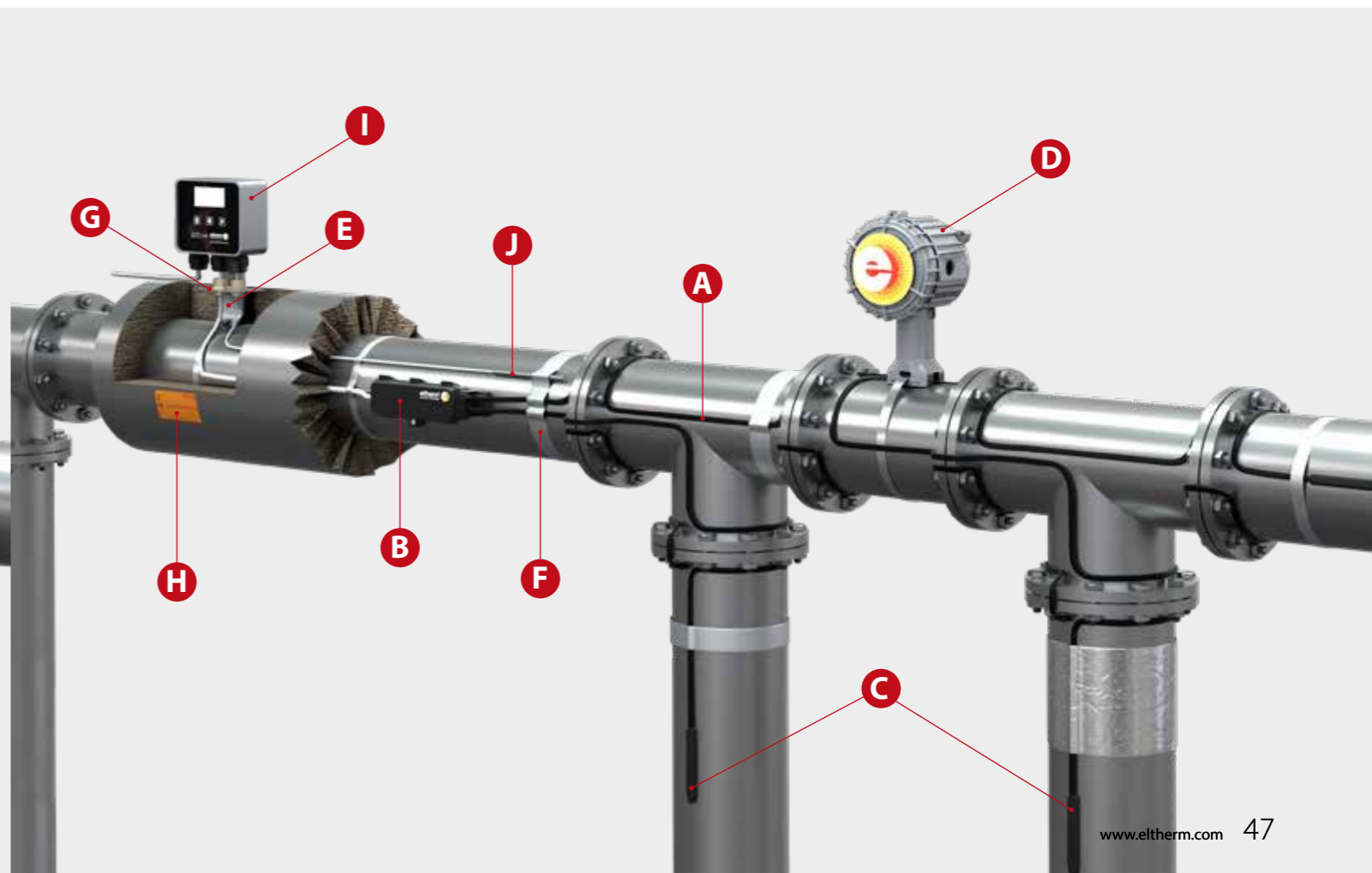
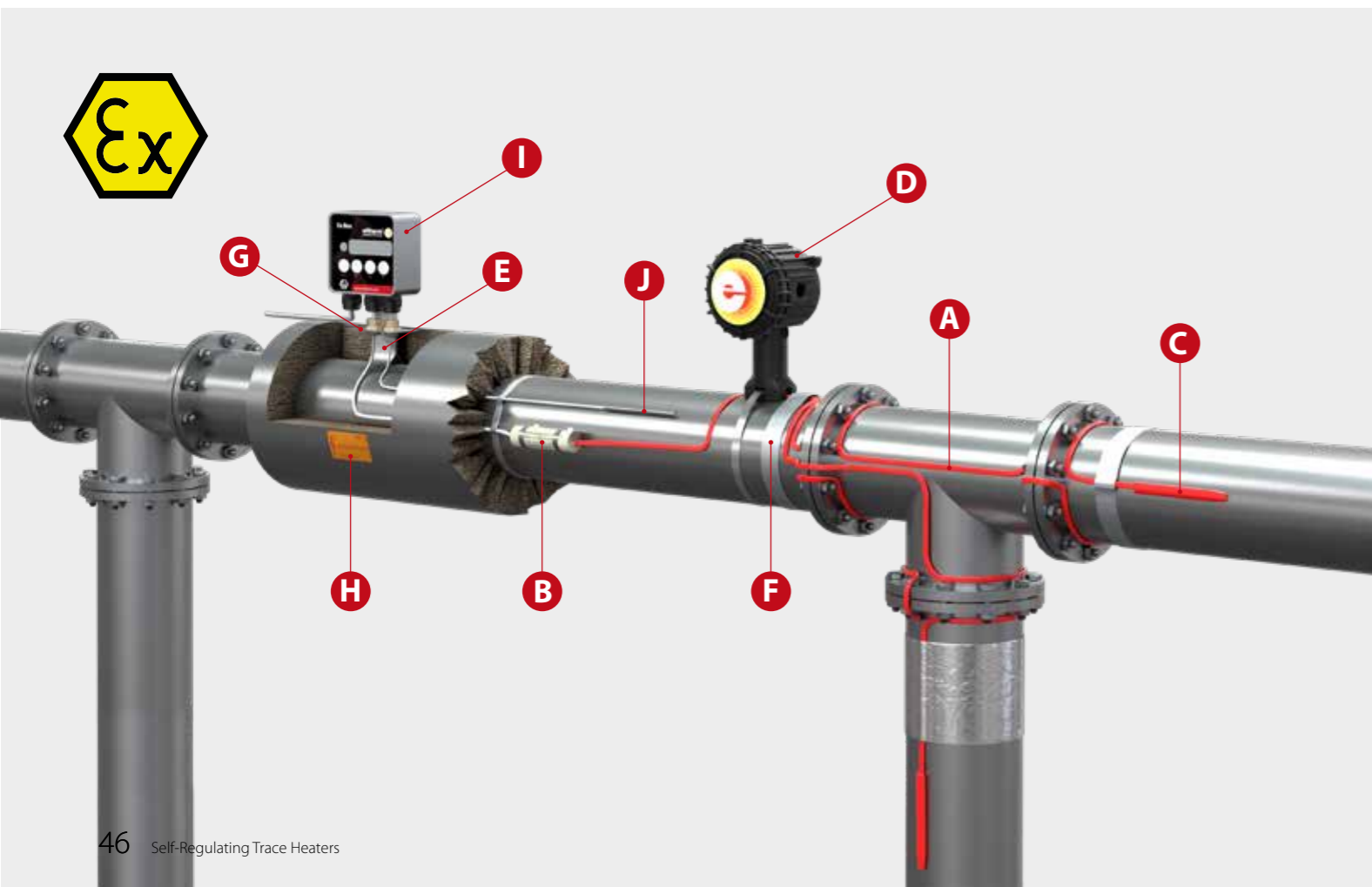



# Design Guide

## Self-Regulating Trace Heater System

Table 1: Design guide freeze prevention +5 °C for self-regulating trace heaters, type series ELSR-N-10...40-2-BO(T)

Pipe size	Inches: DN	1/2 15	3/4 20	1 25	1 1/4 32	1 1/2 40	2 50	2 1/2 65	3 80	4 100	5 125	6 150	7 175	8 200	9 225	10 250	12 300
10	Ambient temperature, min. (°C)	Heating cable Type ELSR-N-10...40-2-BO(T)															
	-15	10	10	20	20	30	30	30	40	2x30	2x30	2x40	2x40	2x40	3x30	3x40	3x40
	-20	10	20	20	20	30	30	40	40	2x30	2x30	2x40	2x40	3x30	3x40	3x40	4x40
20	-15	10	10	10	10	10	20	20	20	30	30	30	40	40	40	2x30	2x30
	-20	10	10	10	10	20	20	20	30	30	30	40	2x30	2x30	2x30	2x30	2x40
	-25	10	10	20	20	30	30	30	30	40	40	2x30	2x30	2x30	2x30	2x40	2x40
30	-15	10	10	10	10	10	10	10	20	20	20	20	30	30	30	40	40
	-20	10	10	10	10	10	20	20	20	20	20	20	30	40	40	40	2x30
	-25	10	10	10	10	20	20	30	30	30	30	40	2x30	2x30	2x30	2x30	2x30
40	-15	10	10	10	10	10	10	10	10	20	20	20	20	20	20	30	30
	-20	10	10	10	10	10	10	20	20	20	20	20	30	30	30	30	40
	-25	10	10	10	10	10	20	20	20	20	20	20	30	30	40	40	2x30
50	-15	10	10	10	10	10	10	10	10	10	20	20	20	20	20	20	30
	-20	10	10	10	10	10	10	10	10	20	20	20	20	30	30	30	30
	-25	10	10	10	10	10	10	20	20	20	20	20	30	30	30	30	40
60	-15	10	10	10	10	10	10	10	10	10	10	10	20	20	20	20	20
	-20	10	10	10	10	10	10	10	10	10	10	10	20	20	20	20	30
	-25	10	10	10	10	10	10	10	10	20	20	20	20	30	30	30	30
80	-15	10	10	10	10	10	10	10	10	10	10	10	10	20	20	20	20
	-20	10	10	10	10	10	10	10	10	10	10	10	20	20	20	20	20
	-25	10	10	10	10	10	10	10	10	20	20	20	20	20	20	20	30
100	-15	10	10	10	10	10	10	10	10	10	10	10	10	10	20	20	20
	-20	10	10	10	10	10	10	10	10	10	10	10	10	20	20	20	20
	-25	10	10	10	10	10	10	10	10	10	10	10	10	20	20	20	20

Basis: Thermal conductivity of the insulation 0.04 W/mK; increased factor of safety 20 %

Table 2: Trace heater additions (m) for

DN	15	20	25	32	40	50	65	80	100	125	150	175	200	225	1250	300
Pair of flanges	0.2	0.2	0.2	0.3	0.3	0.3	0.3	0.3	0.6	0.7	0.8	0.8	0.8	0.8	0.8	0.8
Flanged fitting	0.4	0.4	0.4	0.55	0.55	0.55	0.55	0.55	1.5	2.0	2.4	2.4	2.4	2.4	2.4	2.4
Pumps	1.5	1.5	1.5	2.0	2.0	2.0	2.0	2.0	5.0	5.0	6.0	6.0	6.0	6.0	6.0	6.0

For non-insulated pipe supports: Heating pipe allowance = 4 x support width. Per heating pipe connection in the terminal box / thermostat: Heating pipe allowance approx. 0.5 m. Attention: If there is multiple laying of the heating pipes, the allowances above must be correspondingly multiplied.



Table 3: Heat loss of pipelines in W/m at 10 °K temperature difference

Pipe size	Inches: DN	1/2 15	3/4 20	1 25	1 1/4 32	1 1/2 40	2 50	2 1/2 65	3 80	4 100	5 125	6 150	7 175	8 200	9 225	10 250	12 300
Insulation thickness (mm)	DELTA T																
10	10	4.4	5.2	6.1	7.8	8.7	10.5	12.9	14.8	18.6	22.3	26.6	30.3	34.1	37.8	41.9	49.3
20	10	2.9	3.3	3.7	4.5	5.0	5.9	7.1	8.1	10.0	11.9	14.1	16	17.8	19.7	21.9	25.6
30	10	2.2	2.6	2.9	3.4	3.7	4.2	5.2	5.8	7.1	8.4	9.8	11.1	12.4	13.7	15.1	17.6
40	10	1.9	2.2	2.5	2.8	3.1	3.5	4.2	4.7	5.7	6.6	7.7	8.7	9.6	10.6	11.7	13.6
50	10	1.7	2.0	2.2	2.5	2.7	3.0	3.6	4.0	4.8	5.6	6.4	7.2	8.0	8.8	9.6	11.2
60	10	1.6	1.8	2.0	2.2	2.4	2.7	3.2	3.6	4.2	4.9	5.6	6.2	6.9	7.5	8.2	9.5
80	10	1.4	1.6	1.7	1.9	2.1	2.3	2.7	3.0	3.4	3.9	4.5	5.0	5.5	6.0	6.5	7.5
100	10	1.3	1.4	1.5	1.7	1.8	2.0	2.4	2.6	3.0	3.4	3.8	4.2	4.6	5.1	5.5	6.3
120	10	1.2	1.3	1.4	1.6	1.7	1.9	2.2	2.3	2.7	3.0	3.4	3.7	4.1	4.4	4.8	5.4

Basis: Thermal conductivity of the insulation 0.04 W/mK; increased factor of safety 20 %. If there are other thermal conductivity figures, the values must be multiplied by a corresponding factor.

**Example:** Thermal conductivity of the insulation 0.045 W/mK

$$\frac{0,045 \text{ W/mK}}{0,040 \text{ W/mK}} = 1,125$$

### Example 1

Task: Frost protection for a DN 100, 25 m long pipeline with 2 pairs of flanges, 1 fitting, 1 pump, 4 supports 0.1 m wide; at an ambient temperature of -25 °C and with a 50 mm thick heat insulation, 230 V.

Design:	from table 1:	Heating cable type ELSR-N-20-BO, single laying	
		Pipeline length 25 m single laying = m	= 25.0 m
	from table 2:	Pair of flanges 2 x 0,6 m	= 1.2 m
		Fitting 1 off x 1.5 m	= 1.5 m
		Pump 1 off x 5.0 m	= 5.0 m
		Pipe support 4 off x 0.1 m x 4	= 1.6 m
		Connection 1 off x 0.5 m	= 0.5 m
			<b>= 34.8 m = order 35 m ELSR-N-20-2-BO</b>

### Example 2:

Task: Temperature maintenance for 15 m DN 50 pipeline at 20 °C (caustic soda solution) at minimum ambient temperatures of -10 °C (total DELTA-T of 30 K) and a 40 mm thick heat insulation. Installations: 2 pairs of flanges, 2 fittings, 230V.

If the heating is designed using type ELSR-N self-regulating heating cables, please proceed as follows to select the correct nominal output: Design (from table 3): DELTA-T 10 K heat loss = 3.5 W/m. As total DELTA-T is 30 K (that is to say is 3x higher than DELTA-T in the table), the value found is multiplied by 3: 3.5 W/m x a factor of 3 = 10.5 W/m.

In the temperature output diagram on the ELSR-N datasheet, the intersection of the two lines heating output W/m = 10.5 and temperature +20 °C is between the curves (ELSR-N-10) and (ELSR-N-20). Select the heating cable with the next highest power output (ELSR-N-20). You can now proceed with the heating pipe allowance for the installations as in Example 1.

# Questionnaire

## Electrical Trace Heating on Pipes



### Customer Data

<b>Company*</b>	_____	<b>Contact*</b>	_____
<b>Street, Code/City*</b>	_____	<b>E-Mail*</b>	_____
<b>Website</b>	_____	<b>Phone*</b>	_____

### Project Details

**Application**

Freeze prevention  
 Temperature maintenance  
 Heating up & temperature maintenance

**Supply voltage\*** \_\_\_\_\_

**Maintain temperature\*** \_\_\_\_\_ °C

**Product temperature** \_\_\_\_\_ °C

**Min. ambient temperature\*** \_\_\_\_\_ °C

**Max. ambient temperature\*** \_\_\_\_\_ °C

**Removable Trace heater**  Yes (Drawing necessary)  No

**Production according to**  Provision  Drawing

### Process Data

**Product \*\*** \_\_\_\_\_

**Density \*\*** \_\_\_\_\_ kg/m<sup>3</sup>

**Spec. heat capacity \*\*** \_\_\_\_\_ kj/kg\*K

**Spec. melting heat \*\*** \_\_\_\_\_ J/kg

**Phase transition temperature (if applicable) \*\*** \_\_\_\_\_ °C

**Switch-on temperature** \_\_\_\_\_ °C

**Initial temperature \*\*** \_\_\_\_\_ °C

**End temperature \*\*** \_\_\_\_\_ °C

**Max. operating temperature (energized)** \_\_\_\_\_ °C

**Max. temperature (for a short time) e.g. steam-rinsing (de-energized)** \_\_\_\_\_ °C

**Desired heat-up time \*\*** \_\_\_\_\_ h

### Details of the Pipes

**Length** \_\_\_\_\_ mm

**Nominal diameter** \_\_\_\_\_ mm

**Material** \_\_\_\_\_

**Spec. heat capacity (pipe material)** \_\_\_\_\_ kj/kg\*K

**Density (pipe material) \*\*** \_\_\_\_\_ kg/m<sup>3</sup>

**Weight per meter (of pipe)** \_\_\_\_\_ kg/m

**Wall thickness \*\*** \_\_\_\_\_ mm

Valves: \_\_\_\_\_ Flanges: \_\_\_\_\_

Quantity of Supports: \_\_\_\_\_ Pumps/filters: \_\_\_\_\_ Tee connections: \_\_\_\_\_

**Location**  Indoors  Outdoors

**Exposure to moisture?**  Yes  No

### Temperature Control

**Control**

Provided by customer  Pluggable  
 Capillary tube thermostat  
 Complete control cabinet  
 Electronic temperature controller

**Temperature sensor (Electronic temperature controller)**

NiCrNi  FeCuNi  Pt-100

2-wire  3-wire  4-wire

**Installation (Electronic temperature controller)**

T-rail  Wall mounting  
 Door installation  
 Mounting bracket / Pipe mounting

### Hazardous Area

**Installation in hazardous areas**  Yes  No EX-Zone: \_\_\_\_\_

**Temperature class**

T1  T2  T3  
 T4  T5  T6

**Certification in accordance w.** \_\_\_\_\_

### Installation information

**Installation by eltherm**  Yes  No

**Installation location** \_\_\_\_\_

### Thermal Insulation Details

**Material** \_\_\_\_\_

**Thickness\*** \_\_\_\_\_ mm

**Heat conductivity** \_\_\_\_\_ W/(m-K)

**Density** \_\_\_\_\_ kg/m<sup>3</sup>

**Max. temperature limit of insulation** \_\_\_\_\_ °C

\* Please fill in all required fields

\*\* Information only required for heating up

Please enclose technical illustration as attachment!

**➤ Please find the interactive form on our Website!**

# 75.000 km

of trace heaters spanning twice the circumference of the globe in the course of a decade are used in a wide range of industries.

## 500 bar

and process temperatures up to 450 °C is what eltherm's heated pressure hose systems are built for in industrial applications.

## 5 Continents 13 Locations

## 270 Staff Members

work for eltherm all over the world. And for you and your heat tracing challenges.

## 2.777 Football Fields

is the ground space covered by the solar power plant NOOR in Morocco. Electrical heat tracing performs vital functions there.

## Eight Engineering Hubs

provide engineering solutions for turnkey projects and EPC requirements all over the world.

## Twenty-three Nations

The eltherm team is multinational. We are natives of a total of 23 nationalities.

## 550 °C

Molten salts must be kept at this temperature to keep them flowable. They store the sun's energy in concentrated solar power plants.



A contribution to sustainability and climate protection: The eltherm fleet operation was rated carbon-neutral in 2018. To achieve this objective, 143 t CO<sub>2</sub> emissions were compensated by supporting global climate protection projects.

## At Your Service eltherm globally

- |                           |                         |
|---------------------------|-------------------------|
| Milano/Italy              | italia@eltherm.com      |
| Shanghai/China            | china@eltherm.com       |
| Barcelona/Spain           | spain@eltherm.com       |
| Singapore                 | asiapacific@eltherm.com |
| Newbury/United Kingdom    | uk@eltherm.com          |
| Burlington/Canada         | canada@eltherm.com      |
| Calgary/Canada            | canada@eltherm.com      |
| Korolev/Russia*           | russia@eltherm.com      |
| Johannesburg/South Africa | southafrica@eltherm.com |
| Burbach/Germany           | deutschland@eltherm.com |
| Casablanca/Morocco        | morocco@eltherm.com     |
| Santiago de Chile/Chile   | chile@eltherm.com       |
| Nur-Sultan/Kazakhstan     | kazakhstan@eltherm.com  |

\*Channel Business Partner

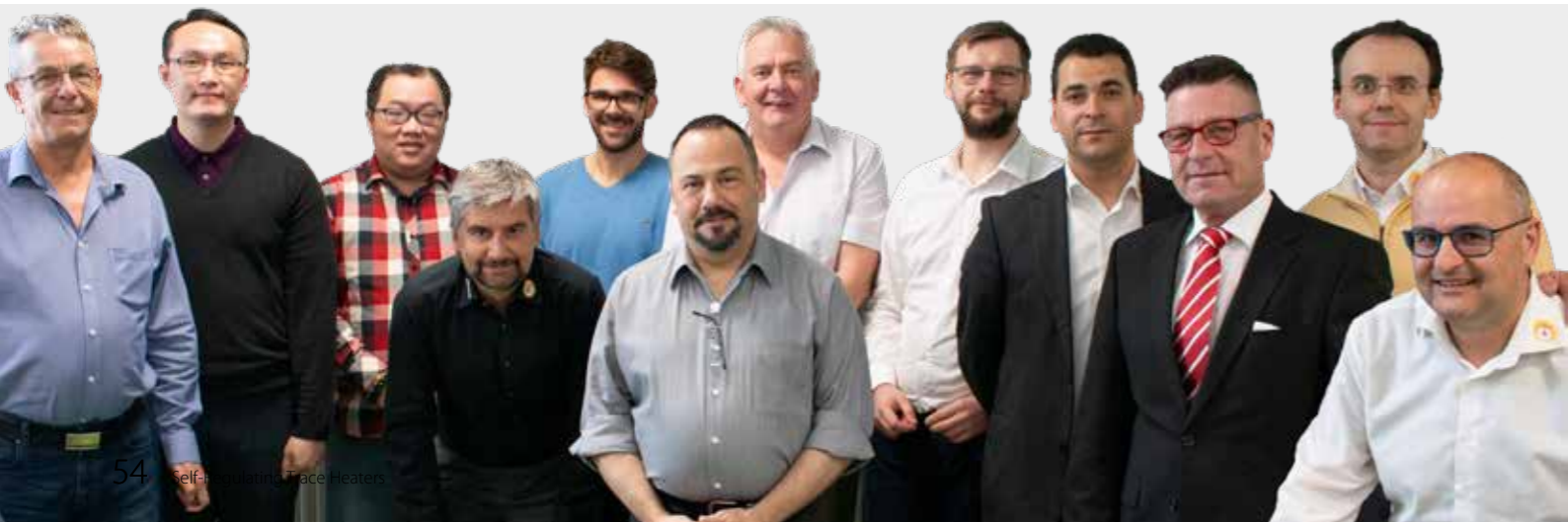

Your eltherm Contact



**eltherm GmbH**  
**Headquarters**

Ernst-Heinkel-Straße 6-10  
57299 Burbach, Germany

T: +49 2736 4413-0  
F: +49 2736 4413-50  
info@eltherm.com

[www.eltherm.com](http://www.eltherm.com)

