

# BARRIÈRES DE VILLE

## BARRIÈRE MAIN COURANTE LISBONNE

### CARACTÉRISTIQUES TECHNIQUES

- > Deux longueurs : 1000 et 1500 mm
- > Hauteur hors tout : 1180 mm
- > Hauteur hors sol : 1000 mm
- > Poteaux : tubes acier 35 x 35 mm, épaisseur 1,5 mm
- > Trois cadres, type "Croix de St André" standard :
  - cadre simple croix 30 x 30 mm avec rondelle centrale Ø 89 mm
  - cadre simple croix 30 x 30 mm avec 2 rosaces
  - cadre simple croix 25 x 15 mm avec grillage en fil de Ø 4 mm
- > Main courante au confort tactile qui, grâce à son léger débordement du cadre, permet une installation en ligne continue

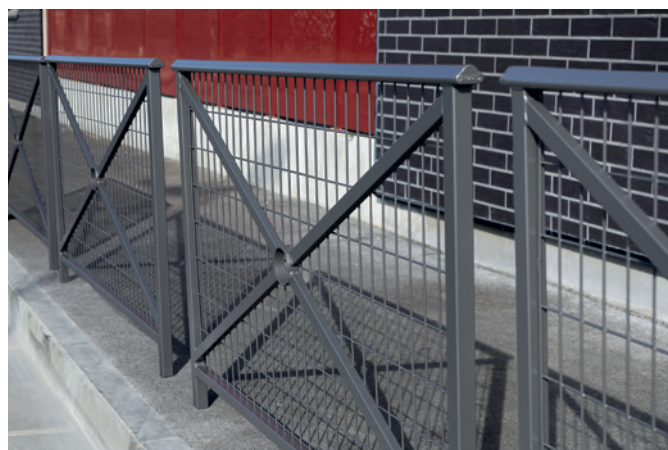

Réf. 206221



### RECOMMANDATIONS DE POSE

- > Pose par scellement direct

### OPTIONS

- > Kit d'amovibilité Serrubloc® pour barrières de ville composé de deux fourreaux d'amovibilité, dont l'un est verrouillable par clé triangle. Auto-drainants : se posent à fond de fouilles. Réf. 203400
- > Pose sur platines ovales

### RÉFÉRENCES





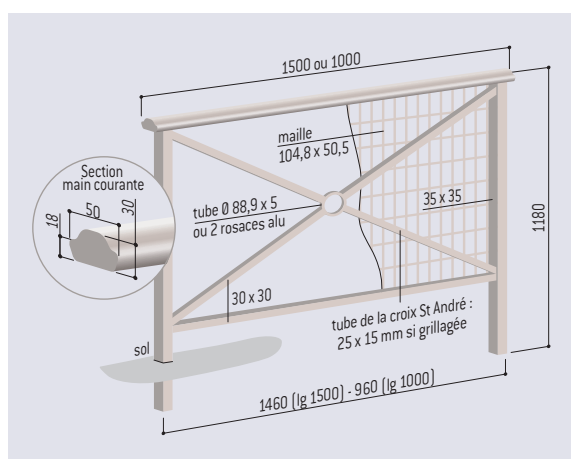





	Lg 1000 mm	Lg 1500 mm
 Simple croix	206200	206201
 Rosace	206232	206233
 Grillagé	206220	206221

### SCHEMA



### FINITION PEINTURE

- > Acier peint sur zinc selon nos coloris

				
RAL 3020	RAL 3004	RAL 5010	RAL 6005	RAL 8017
				
RAL 7044	RAL 9010	RAL 9005	Gris PROCITY®	Aspect Corten

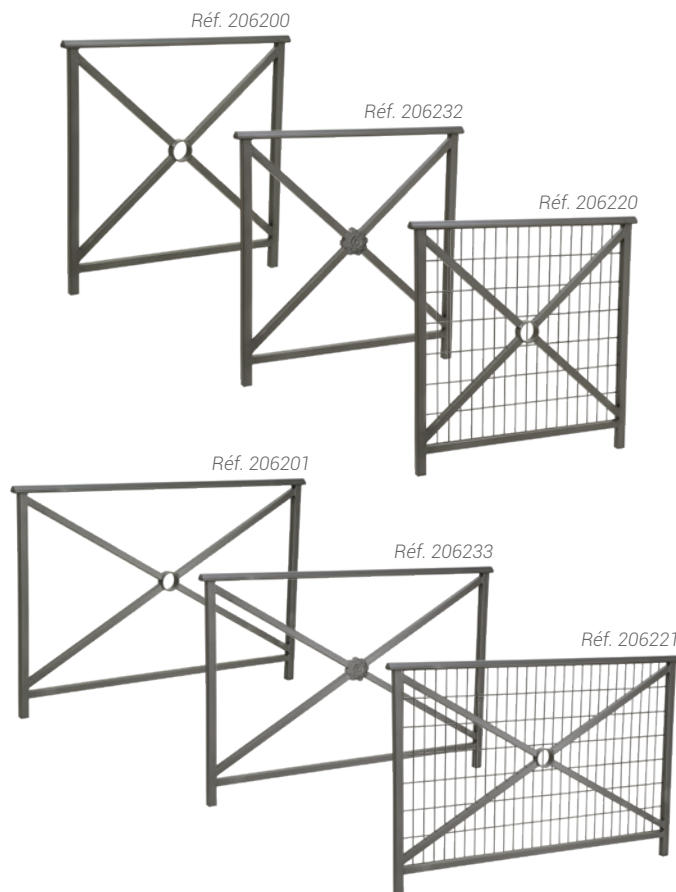

Kit d'amovibilité Serrubloc® Réf. 203400

