

House	Russelia 4.4 ISO	Sheet	1
Drawing	3D	Scale	
Material	4.4x135	Date	05.02.2018
Drawer	RP	File	Russelia 4.4 ISO 3D.dwg

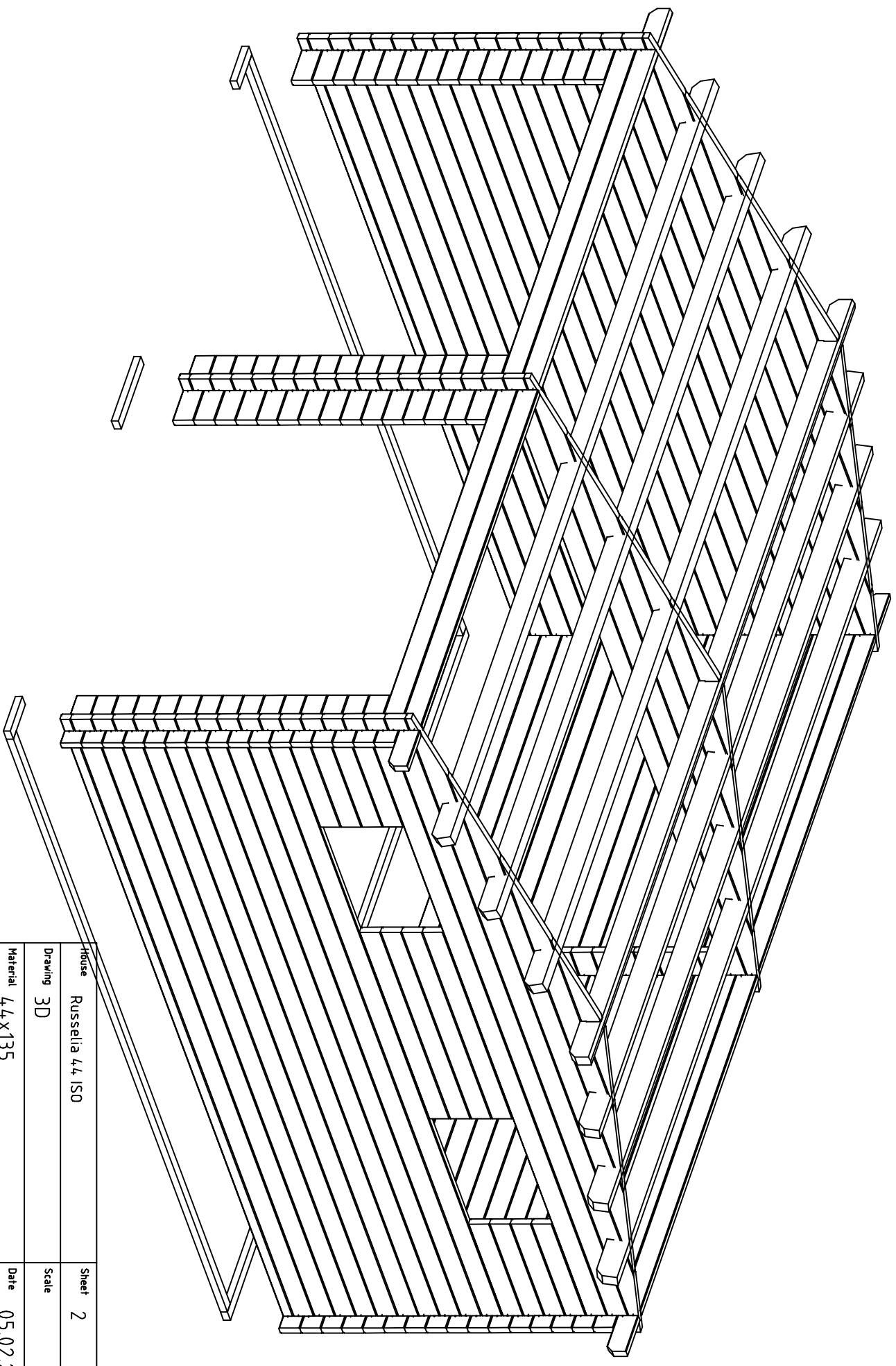

House
Russellia 44 ISO

Sheet 2

Scale

3D

Material 44x135

Date 05.02.2018

Drawer RP

File Russellia 44 ISO 3D.dwg

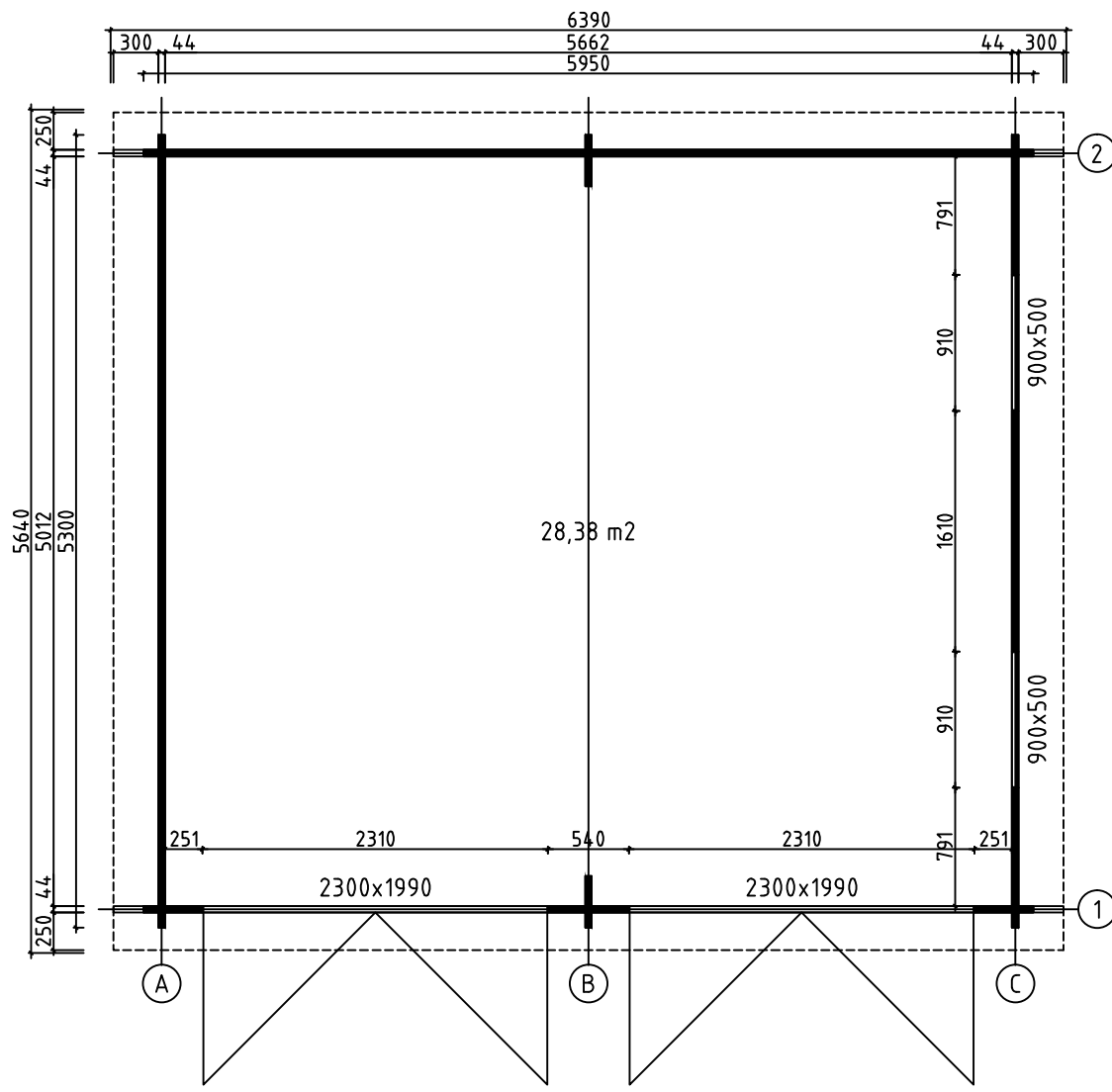

House	Russelia 44 ISO	Sheet	3
Drawing	GROUNDPLAN	Scale	1:50
Material	44x135	Date	05.02.2018
Drawer	RP	File	Russelia 44 ISO.dwg

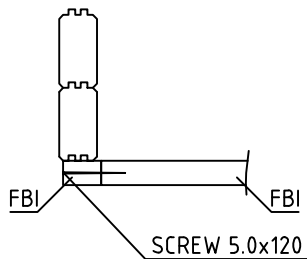
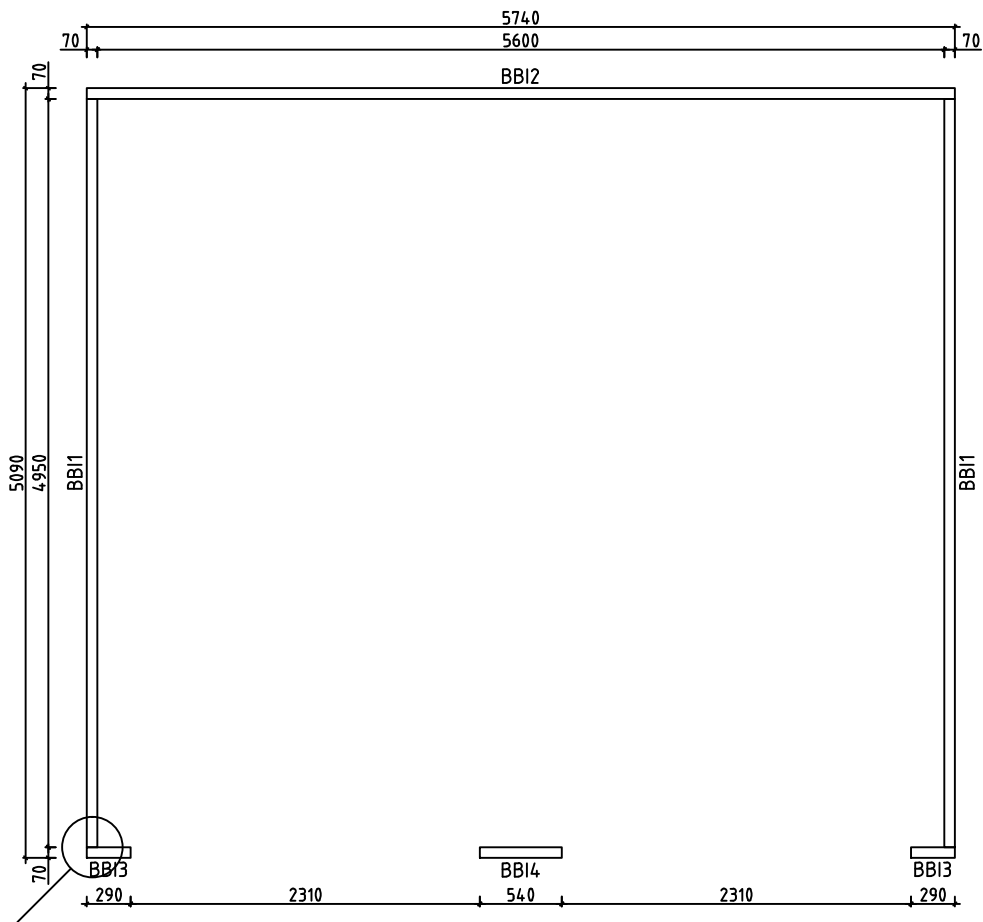

House	Russelia 44 ISO	Sheet	4
Drawing	BASE BEAMS	Scale	1:50
Material	70x45	Date	05.02.2018
Drawer	RP	File	Russelia 44 ISO.dwg

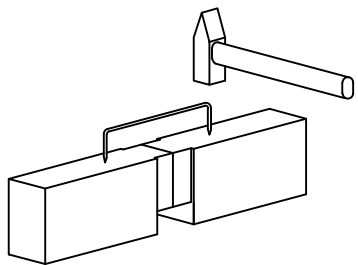
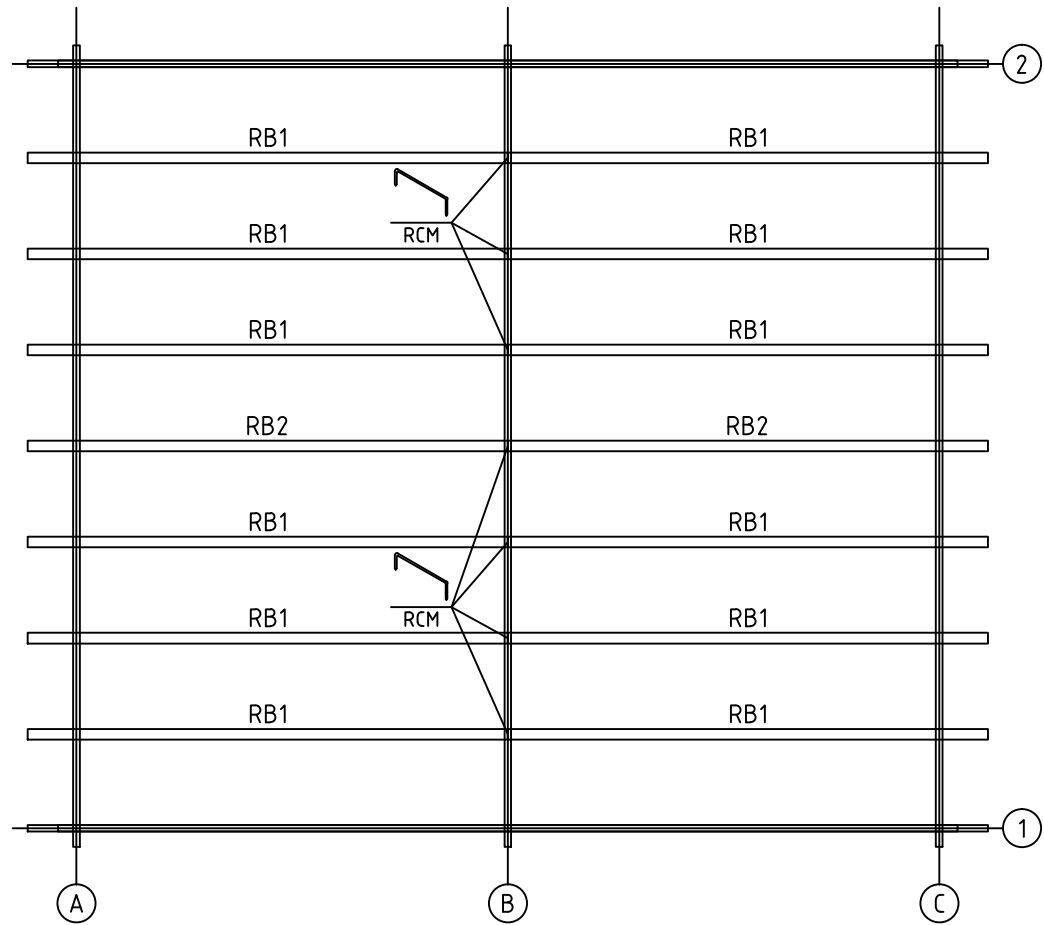

House	Russelia 44 ISO	Sheet	5
Drawing	ROOFBEAMS	Scale	1:50
Material	70x140	Date	05.02.2018
Drawer	RP	File	Russelia 44 ISO.dwg

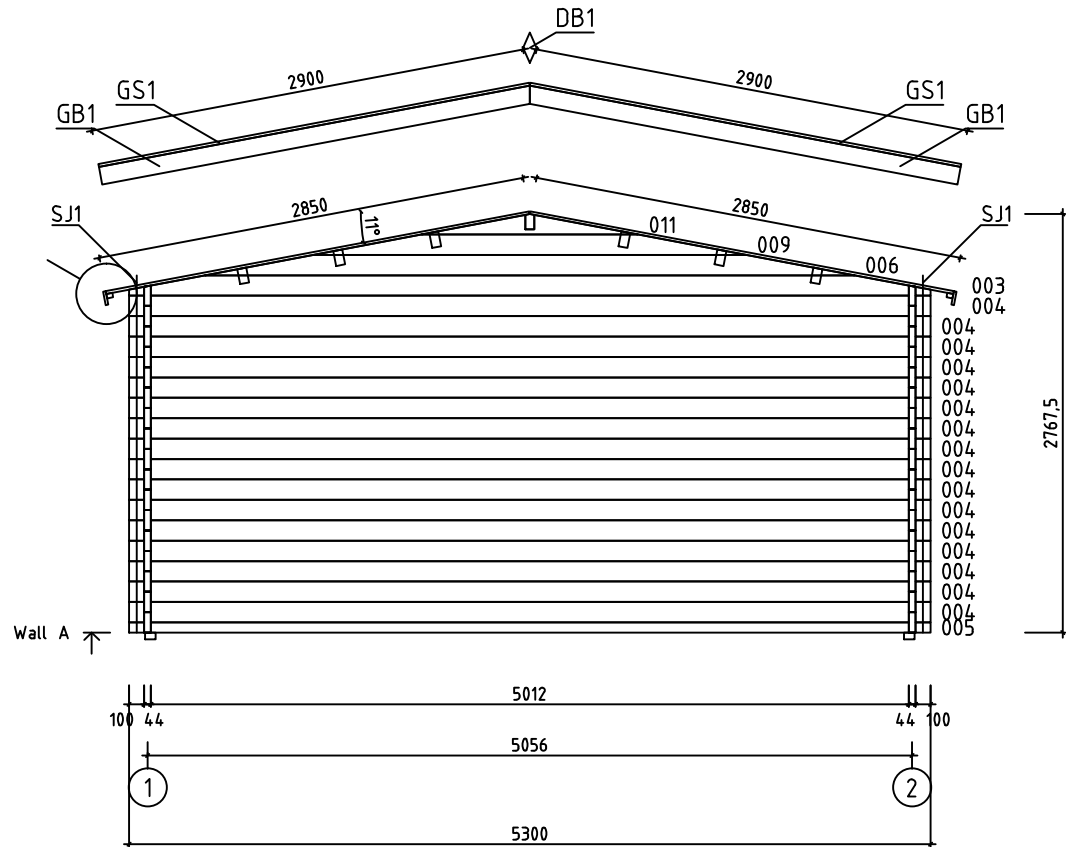
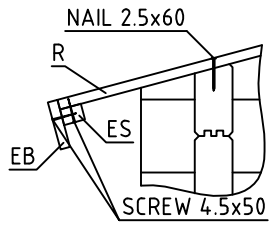

House	Russelia 44 ISO	Sheet	6
Drawing	WALL A	Scale	1:50
Material	44x135	Date	05.02.2018
Drawer	RP	File	Russelia 44 ISO.dwg

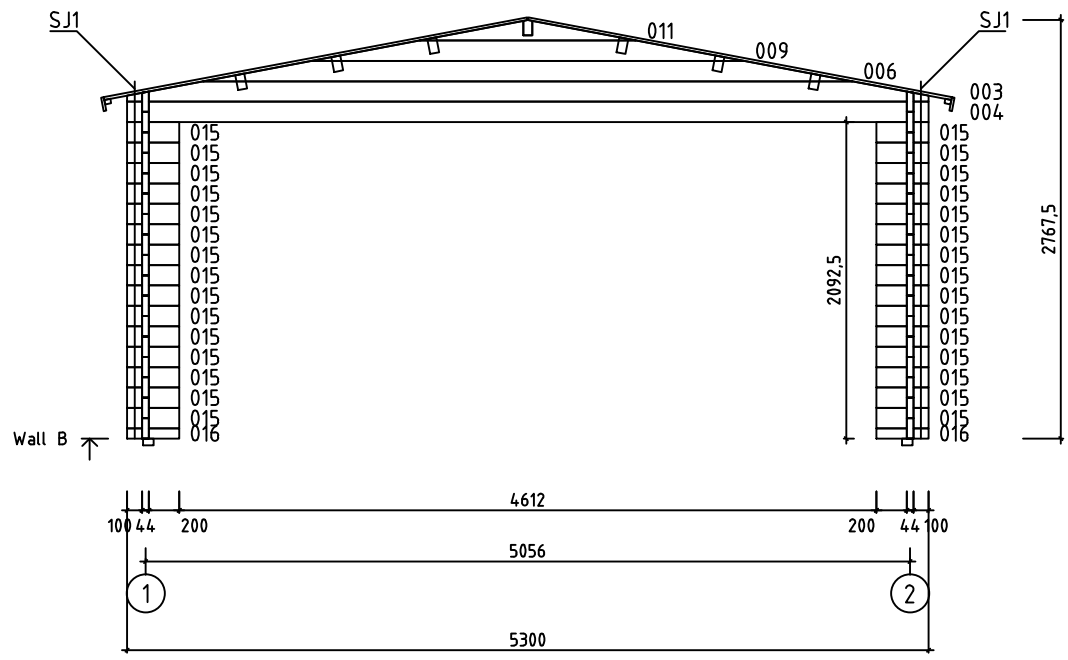

House	Russelia 44 ISO	Sheet	7
Drawing	WALL B	Scale	1:50
Material	44x135	Date	05.02.2018
Drawer	RP	File	Russelia 44 ISO.dwg

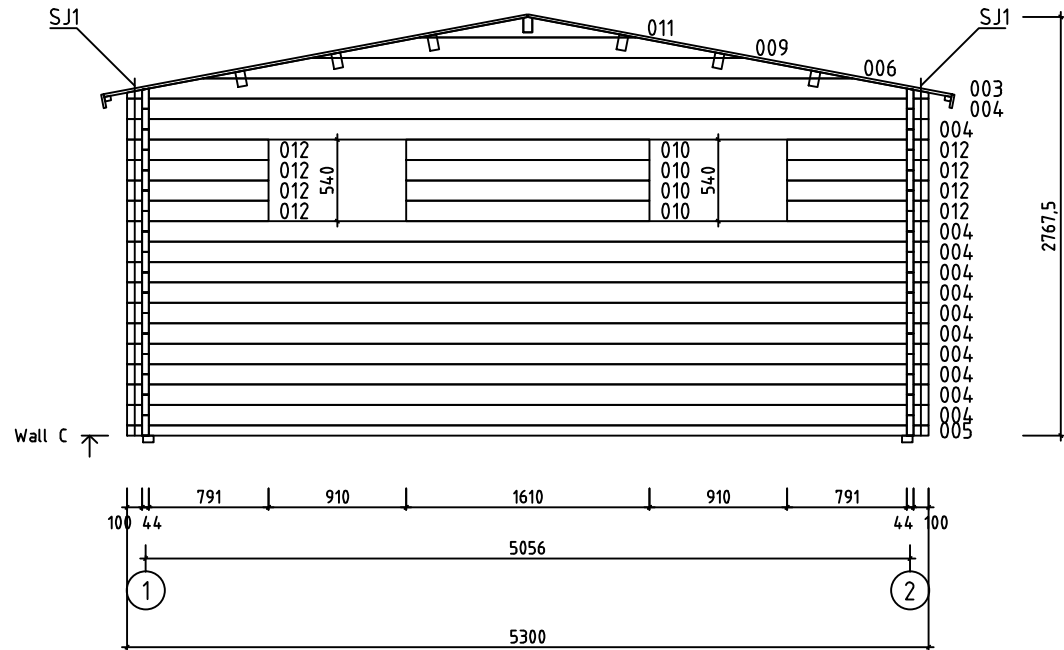



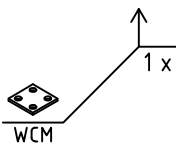
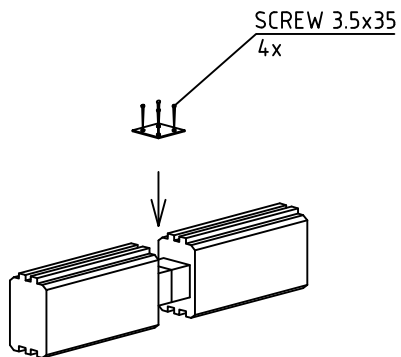
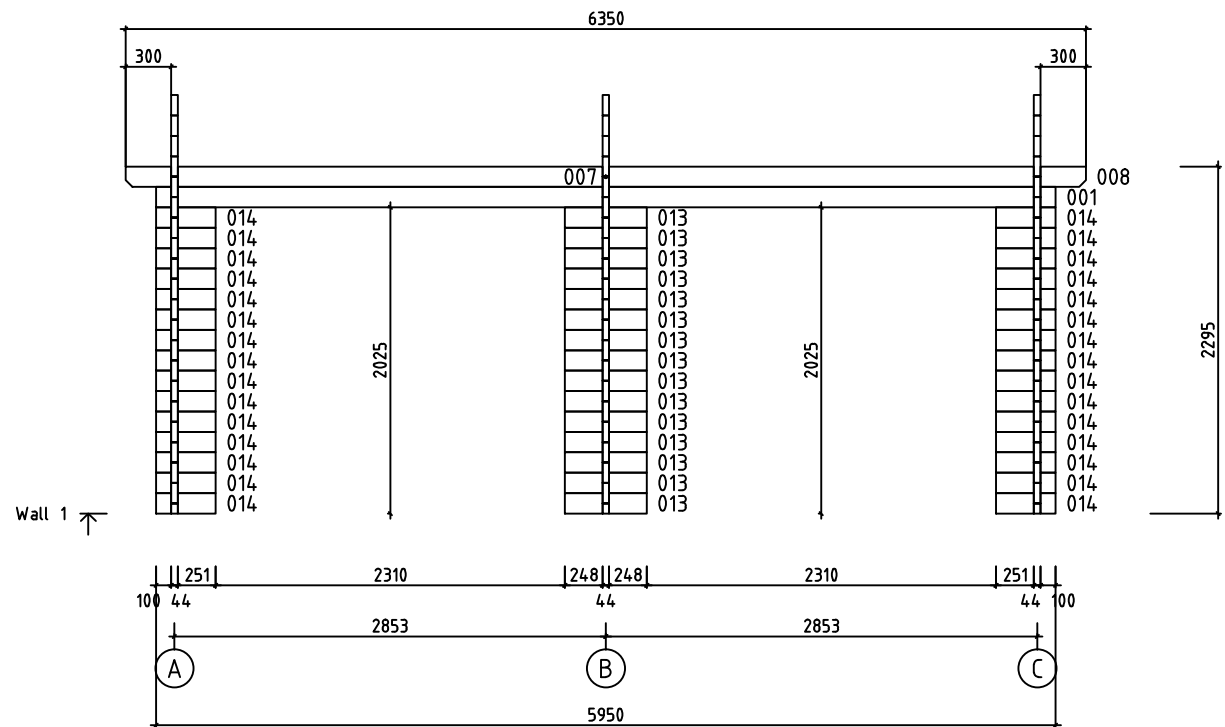



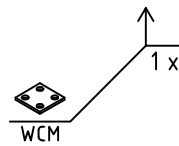
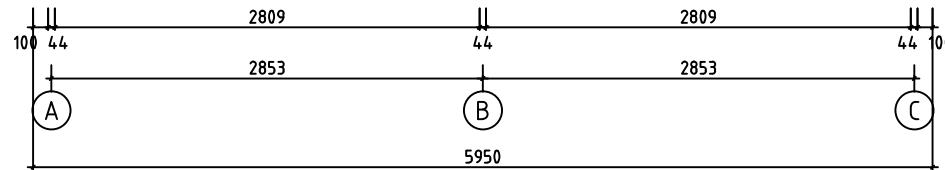
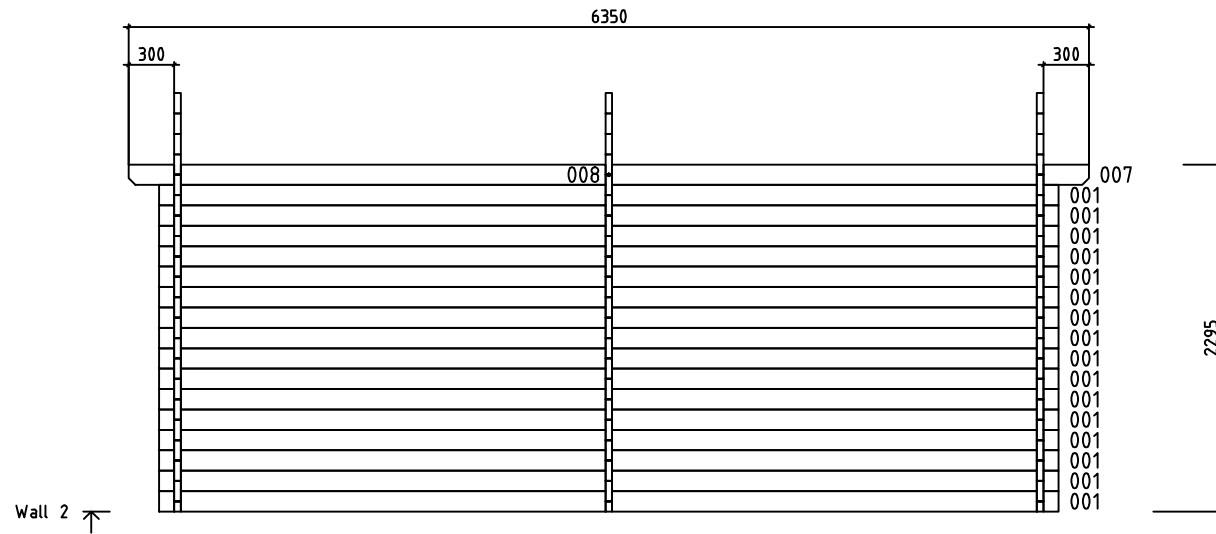



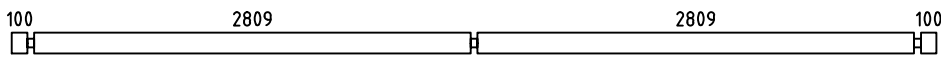
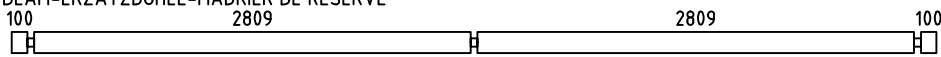
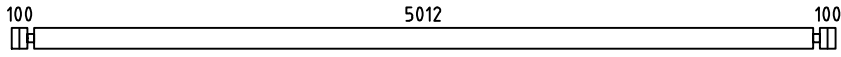
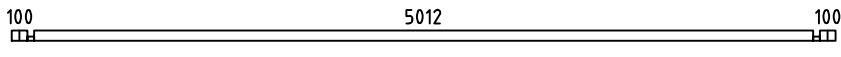
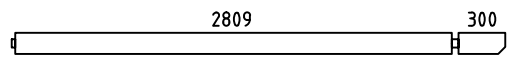
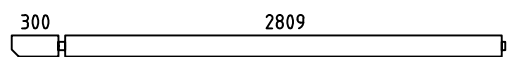
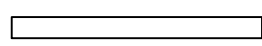
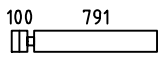

House	Russelia 44 ISO	Sheet	8
Drawing	WALL C	Scale	1:50
Material	44x135	Date	05.02.2018
Drawer	RP	File	Russelia 44 ISO.dwg

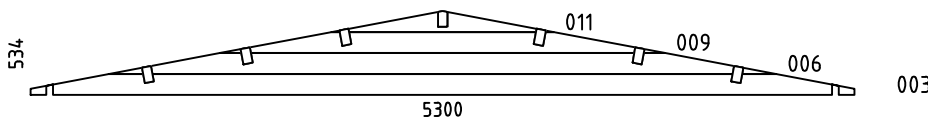

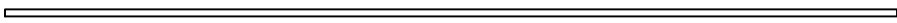
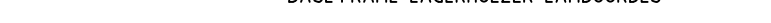

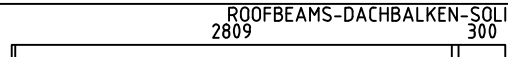
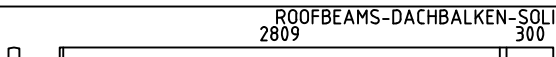

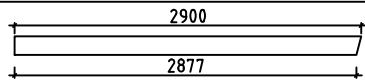









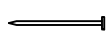



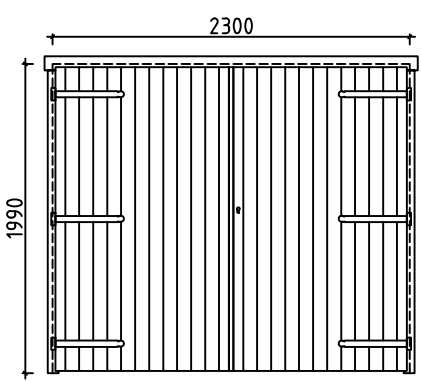

House	Russelia 44 ISO	Sheet	9
Drawing	WALL 1	Scale	1:50
Material	44x135	Date	05.02.2018
Drawer	RP	File	Russelia 44 ISO.dwg

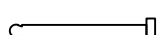
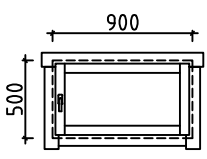

House	Russelia 44 ISO	Sheet	10
Drawing	WALL 2	Scale	1:50
Material	44x135	Date	05.02.2018
Drawer	RP	File	Russelia 44 ISO.dwg

Pos	Specification-Bestimmung-Spécification	PCS	Profile (mm)	L (mm)
001		17	44x135	5950
002	SPARE BEAM-ERZATZBOHLE-MADRIER DE RÉSERVE 	1	44x135	5950
004		29	44x135	5300
005		2	44x68	5300
007		2	44x135	3175
008		2	44x135	3175
010		4	44x135	1610
012		8	44x135	935
013		15	44x135	540
014		30	44x135	395
015		30	44x135	344
016		2	44x68	344
WA-1 WB-1 WC-1		3	44x534	5300
HB	HIT BLOCK-SCHLAGHÖLZER-MADRIERS D'ASSEMBLAGE 	2	44x135	300
BBi2	BASE FRAME-LAGERHÖLZER-LAMBOURDES  IMM	1	70x45	5740
BBi1	BASE FRAME-LAGERHÖLZER-LAMBOURDES  IMM	2	70x45	4950
BBi4	BASE FRAME-LAGERHÖLZER-LAMBOURDES  IMM	1	70x45	540
BBi3	BASE FRAME-LAGERHÖLZER-LAMBOURDES  IMM	2	70x45	290
RB1	ROOFBEAMS-DACHBALKEN-SOLIVES DE PLAFOND 	12	70x140	3175
RB2	ROOFBEAMS-DACHBALKEN-SOLIVES DE PLAFOND 	2	70x140	3175
R1	ROOFBOARD-DACHBRETT-VOLIGES  or-oder-ou	112+2 146+2	18x114 18x88	2850
GB1	GABLE BOARD-GIEBELLENDE-PLANCHE DE RIVE 	4	18x120	2900
GS1	ROOF FELT FILLET-GIEBELLEISTE-BAGUETTES POUR FIXER LES PLANCHES DE RIVE 	4	18x70	2900
EB1	EAVE BOARD-TRAUFBRETT-LATTES SOUS VOLIGES 	4	18x90	3175

Pos	Specification-Bestimmung-Spécification	PCS	Profile (mm)	L (mm)
ES1	EAVE SLAT-TRAUFENLEISTE-BAGUETTES POUR FIXER LES LATTES SOUS VOLIGES 	4	30x40	3175
DB1	DIAMOND-RAUTE-ELÉMENTS DE DÉCORATION 	2	18x90	200
SJ1	SCREW JOINT-GEWINDESTANGE-TIGES FILETÉS 	6	M10	2310
RCM	ROOFBEAMS CONNECTING METAL-DACHBALKEN BEFESTIGUNGSMETALLE -CONNECTEUR MÉTALLIQUE POUR SOLIVES DE PLAFOND 	7	∅6.0	200
WCM	WALLBEAMS CONNECTING METAL-WANDBOHLNEN BEFESTIGUNG -METALLE-PATTE D'ASSEMBLAGE 	2	25	25
	NAIL-NAGEL-CLOUS FOR-FÜR-POUR COATING FOR ROOF-BESCHICHTUNG FÜR DACH-REVÊTEMENT DE TOIT 	520	∅2.5	20
	NAIL-NAGEL-CLOUS FOR-FÜR-POUR R1 	740	∅2.5	60
	SCREWS-SCHRAUBEN-VIS FOR-FÜR-POUR WCM 	8	∅3.5	35
	SCREWS-SCHRAUBEN-VIS FOR-FÜR-POUR GB1, GS1, EB1, ES1, DB1 	100	∅4.5	50
	SCREWS-SCHRAUBEN-VIS FOR-FÜR-POUR 005, 016 	20	∅4.5	90
	SCREWS-SCHRAUBEN-VIS FOR-FÜR-POUR BBI1, BBI2, BBI3, BBI4 	10	∅5.0	120
	SCREWS-SCHRAUBEN-VIS FOR-FÜR-POUR WA-1, WB-1, WC-1, RB1, RB2 	60	∅6.0	160
	COATING FOR ROOF-BESCHICHTUNG FÜR DACH-REVÊTEMENT DE TOIT 	4,0	R = 15m	
	DOUBLEDOR-DOPELTÜR-DOUBLE PORTE (right-rechts-droit) GV 	P	2300	1990
			2	
			2	
			2	
			12	
	WINDOW-FENSTER-FENÊTRE (1x right-rechts-droit; 1x left-links-gauche) ORT_ECO 	P+V	900	500
			2	
			2	
			2	
House	Russelia 44 ISO	Material	File	Russelia 44 ISO.dwg
			Sheet	12

#001	1,2	5950	17
#002		5950	1
#003	A,B,C	5300	3
#004	A,B,C	5300	29
#005	A,C	5300	2
#006	A,B,C	4296	3
#007	1,2	3175	2
#008	1,2	3175	2
#009	A,B,C	2864	3
#010	C	1610	4
#011	A,B,C	1432	3
#012	C	935	8
#013	1	540	15
#014	1	395	30
#015	B	344	30
#016	B	344	2