



## Light Duty Move-a-Side Mobile System



**i Information**  
If in doubt, contact the supplier.

 Read this Guide thoroughly before commencing assembly and retain for future reference.

 Assembly should be undertaken by two competent people, preferably suitably trained shelving installers.

 Tools - rubber or plastic faced mallet, broad blade screwdriver etc etc etc etc etc etc etc.

**⚠ Caution**  
During assembly, ensure to:

 Take care during assembly and in use, particularly when lifting or stretching and when using tools.

 Assemble and locate for use on a suitable level floor surface. Allow adequate working space.

 Dispose of packaging materials responsibly.

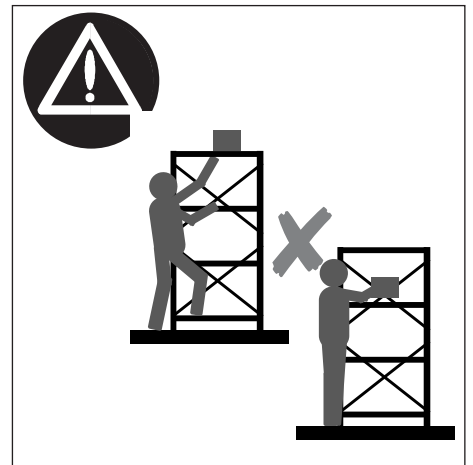

# LIGHT DUTY MOVE-A-SIDE M

## Track Assembly

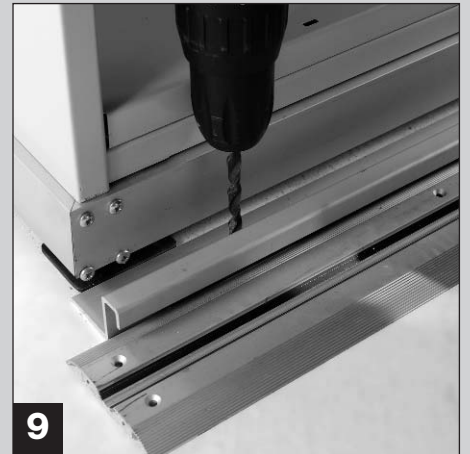
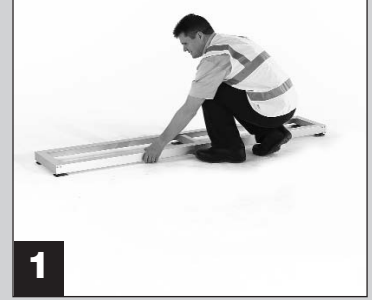
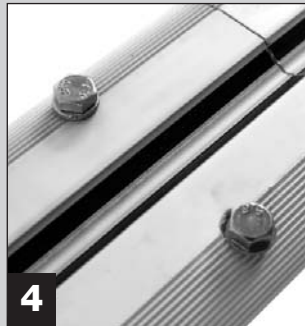

# MOBILE SHELVING ASSEMBLY

## Mobile Assembly



# LIGHT DUTY MOBILE SHELVING ASSEMBLY GUIDE

## Assembly of Optional KD Mobile Chassis

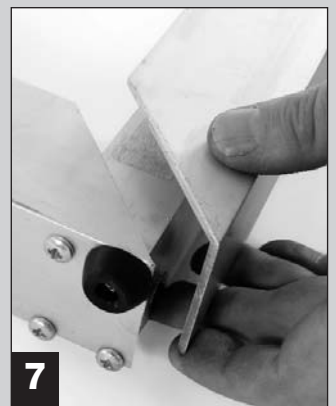
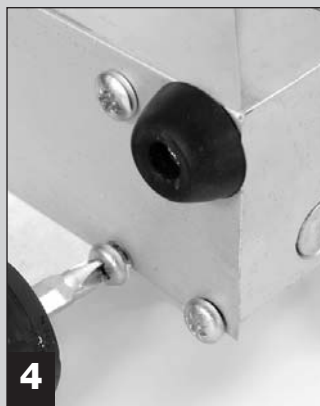
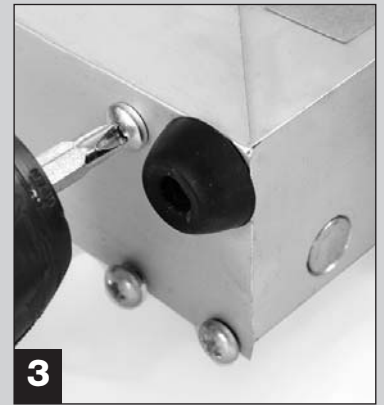
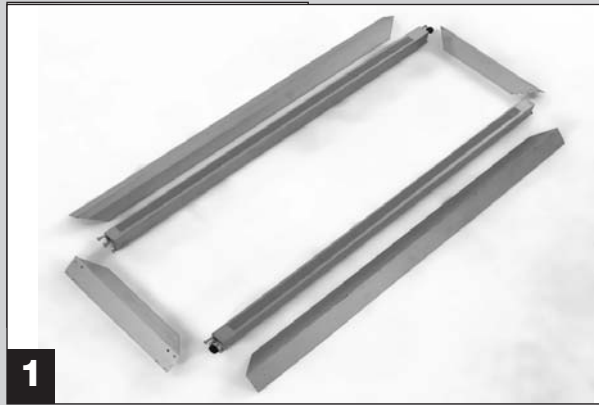

## User Guide

