



# Technical Data

Specification & Capacities



**SPX527CDH-2**

S.N: \_\_\_\_\_



18,5kW/25,0Hp



3,4-12,1m



2700kg



EN 13000

[m] [kg]



# ***SPX527CDH-2***



# ***SPX527CDH-2***





Via Campardone, 1  
31014 Colle Umberto – Italy  
Tel. +39 0438 1710083  
Mail: [info@jekko.it](mailto:info@jekko.it)  
Web: [www.jekko.it](http://www.jekko.it)

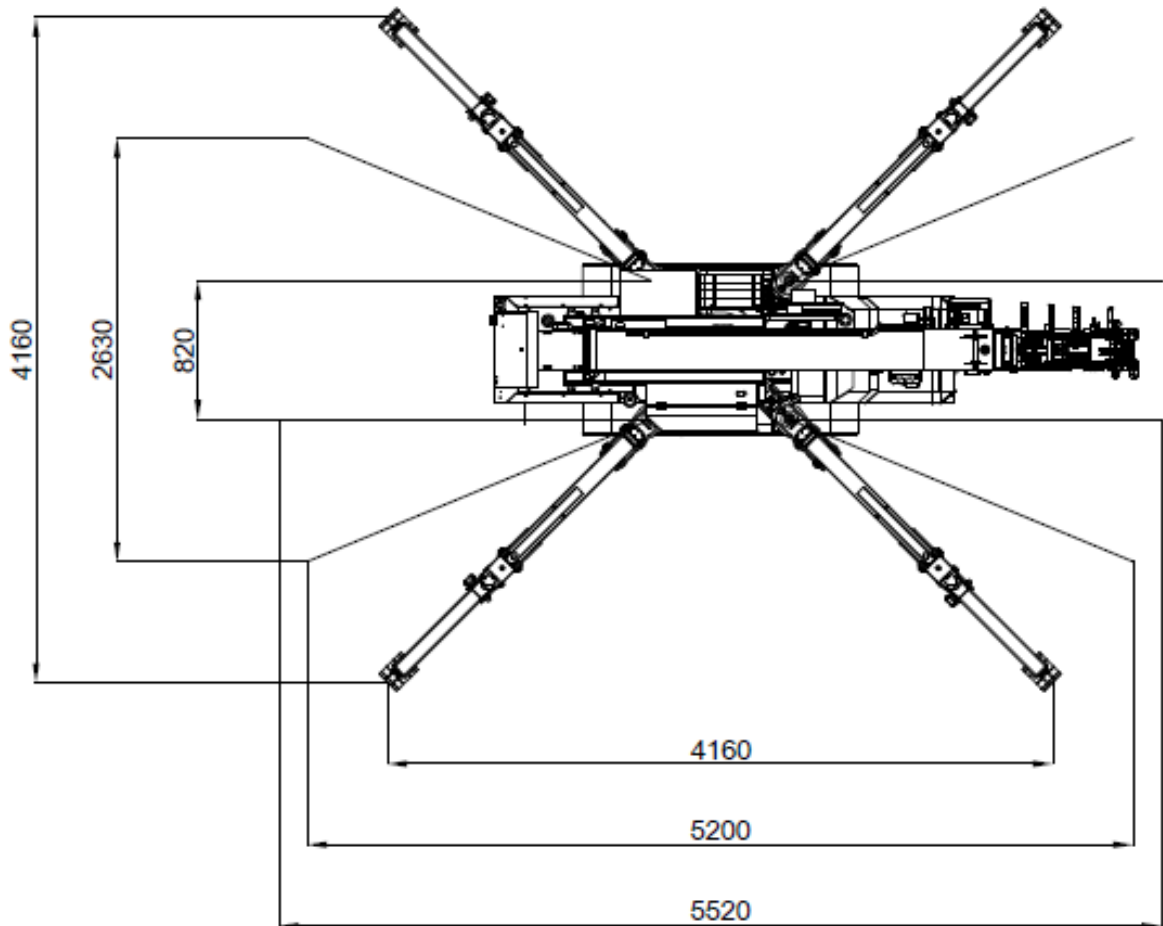
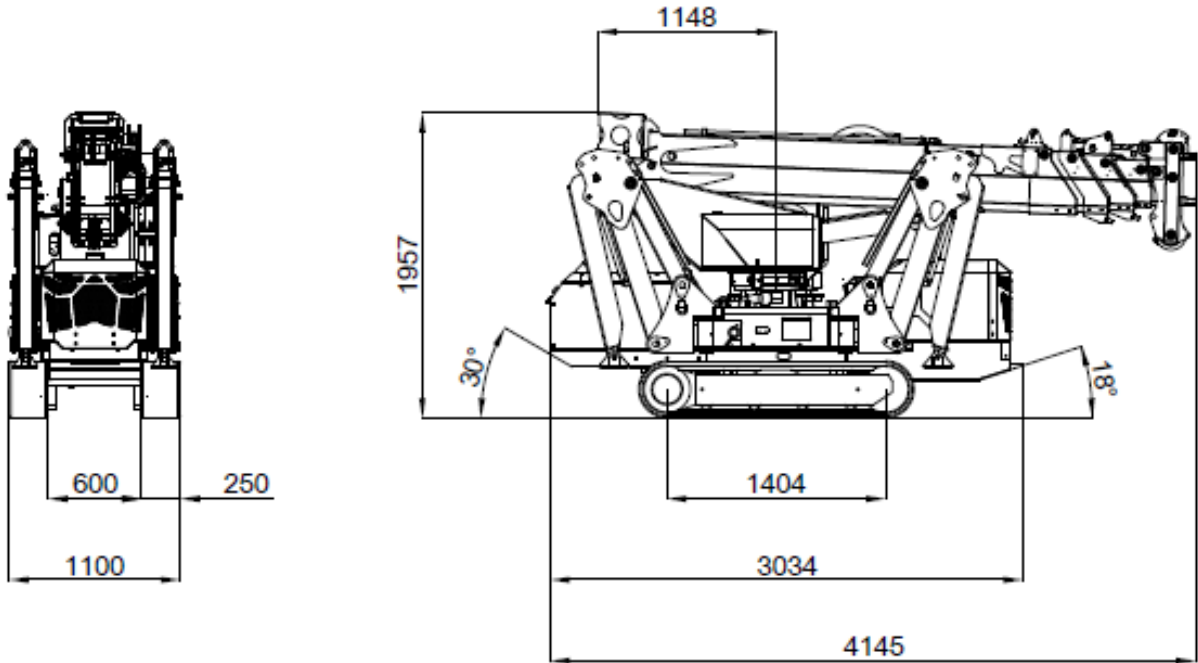

Date	Jan. 27 <sup>th</sup> 2017
REV.	0



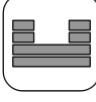

## SPX527CDH-2 - OVERALL DIMENSIONS



		kg
		3600
		0
	<b>Tot.</b>	<b>3600</b>

	km/h	2,0
	25°	
	kg/cm <sup>2</sup>	0,53
	kg	2700

	-2°/80°		35s
	360°		1,0 rpm
	m	3,4-12,1	40s

	KUBOTA D1105-E3B		18,5kW 25,0Hp	
			DIESEL	
			l	20



# SPX527CDH-2

## HOIST PERFORMANCE

Layer	Max Line Pull	Normal Line Speed	High Line Speed
	kg	m/min	m/min
1	1.371 (*)	34,4	N/A
2	1.257 (*)	37,5	N/A
3	1.161 (*)	40,6	N/A

(\*) 900kg LMI limited

Wire Rope	Diameter	Tot. Length	Max Load
	mm	m	kg
19x7 right lang lay Non rotating	8	60	5.435

## HOOK BLOCK

LOAD	No. of	
	Sheaves	Lines
2700	2	3
1800	1	2
900		1



# ***SPX527CDH-2***

## SPX527CDH-2 – MAIN BOOM

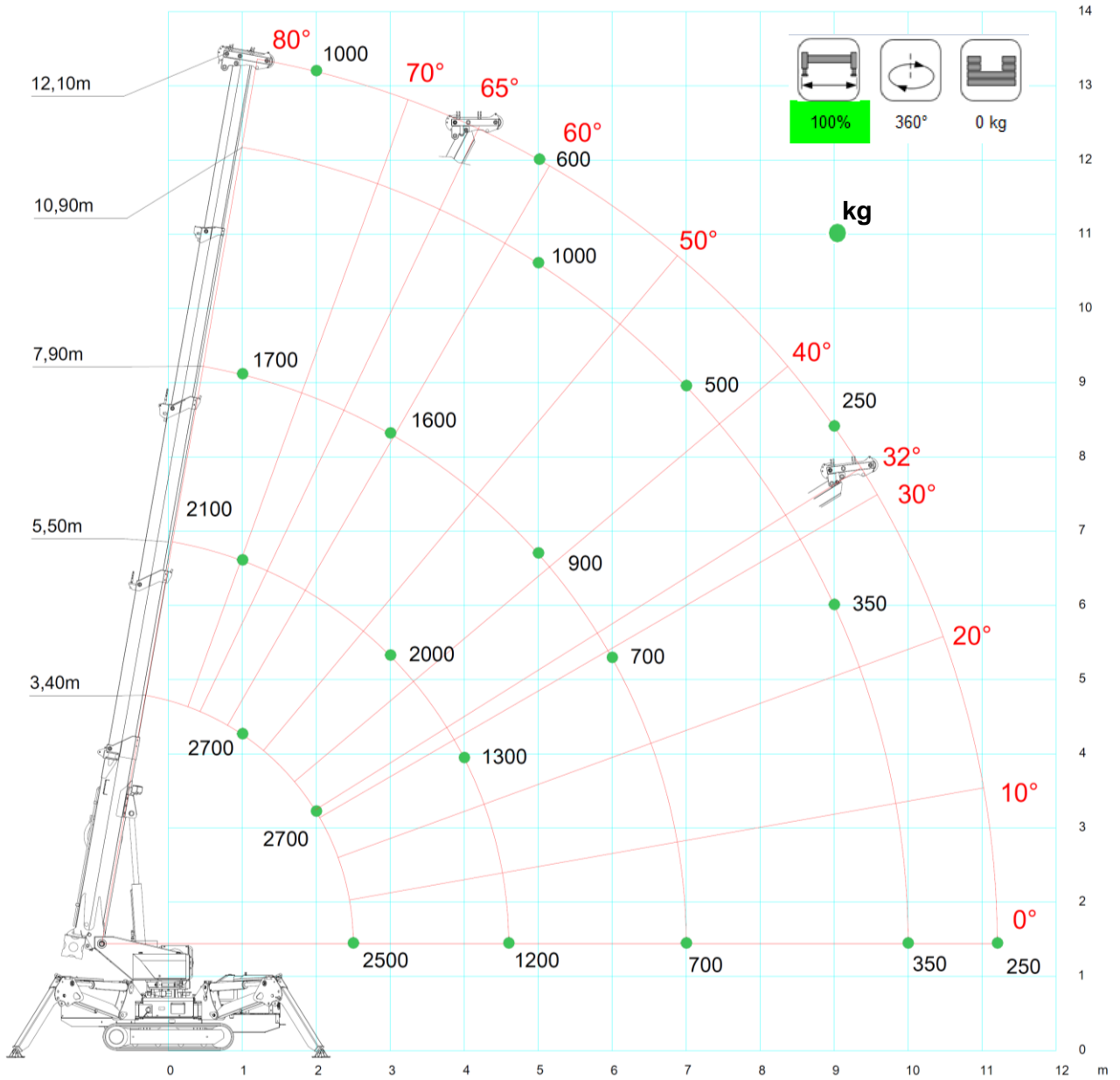



[m] [kg]					EN					
		100%	360°	0 kg						
	3,4	4,4	5,5	6,2	6,9	7,9	8,9	9,9	10,9	12,1
1,0	2700	2500	2100	1900	1800	1700	1600			
2,0	2700	2500	2100	1900	1700	1600	1600	1400	1300	1000
2,5	2500	2300	2000	1800	1700	1600	1500	1400	1300	1000
3,0	2500	2300	2000	1800	1700	1600	1500	1300	1200	1000
4,0		1300	1300	1300	1300	1200	1200	1100	1000	900
4,6			1200	1100	1100	1100	1100	1000	900	700
5,0				1000	1000	900	900	800	700	600
6,0				900	900	700	700	600	600	500
7,0						700	600	500	500	400
8,0							600	500	400	350
9,0								450	350	250
10,0									350	250
11,2										250

SPX0527.00.02.000.1.05.15.A

[m] [kg]						EN	
			>0km/h	180°	0 kg		
	3,4	4,4	5,5				
1,0	300	250	200				
2,0	500	300	200				
2,5	400	250	200				
3,0	200	200	200				

SPX0527.00.03.000.1.05.15.A

## SPX527CDH-2 + JIB800G

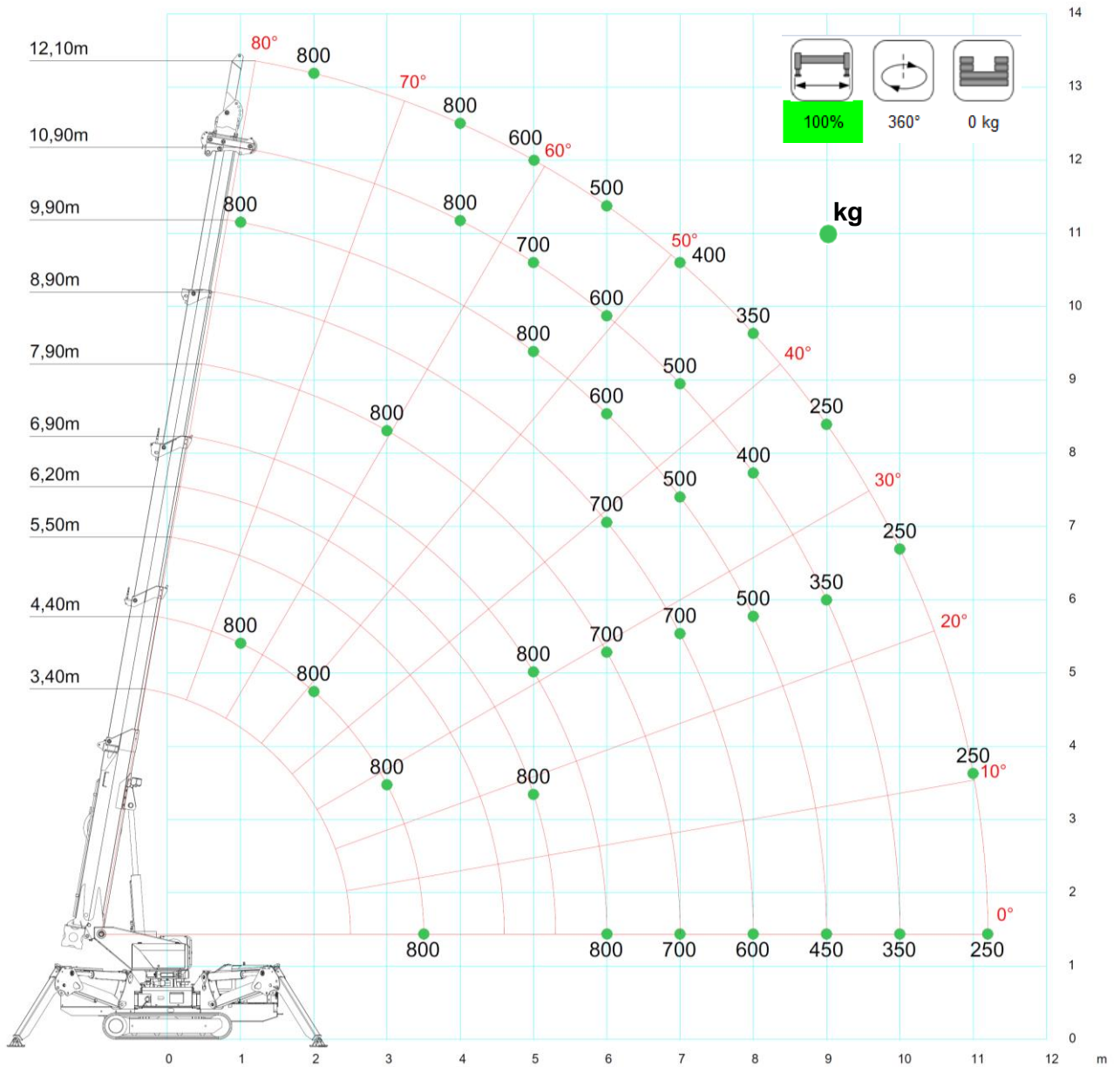

[m] [kg]									
	JIB800G	100%	360°	0 kg					
	4,4	5,5	6,2	6,9	7,9	8,9	9,9	10,9	12,1
1,0	800	800	800	800	800	800	800	800	800
2,0	800	800	800	800	800	800	800	800	800
2,5	800	800	800	800	800	800	800	800	800
3,0	800	800	800	800	800	800	800	800	800
4,0	800	800	800	800	800	800	800	800	800
4,6	800	800	800	800	800	800	800	800	700
5,0		800	800	800	800	800	800	700	600
6,0		800	800	800	700	700	600	600	500
7,0			700	700	700	700	500	500	400
8,0				600	600	600	500	400	350
9,0					450	450	450	350	250
10,0						350	350	350	250
11,2							250	250	250

SPX0527.00.02.310.2.05.15.A

[m] [kg]		>0km/h icon"/>			
	JIB800G	>0km/h	180°	0 kg	
	4,5	5,0			
1,0	200	100			
3,9	200	100			

SPX0527.00.03.310.2.05.15.A

## SPX527CDH-2 + JIB600.2H

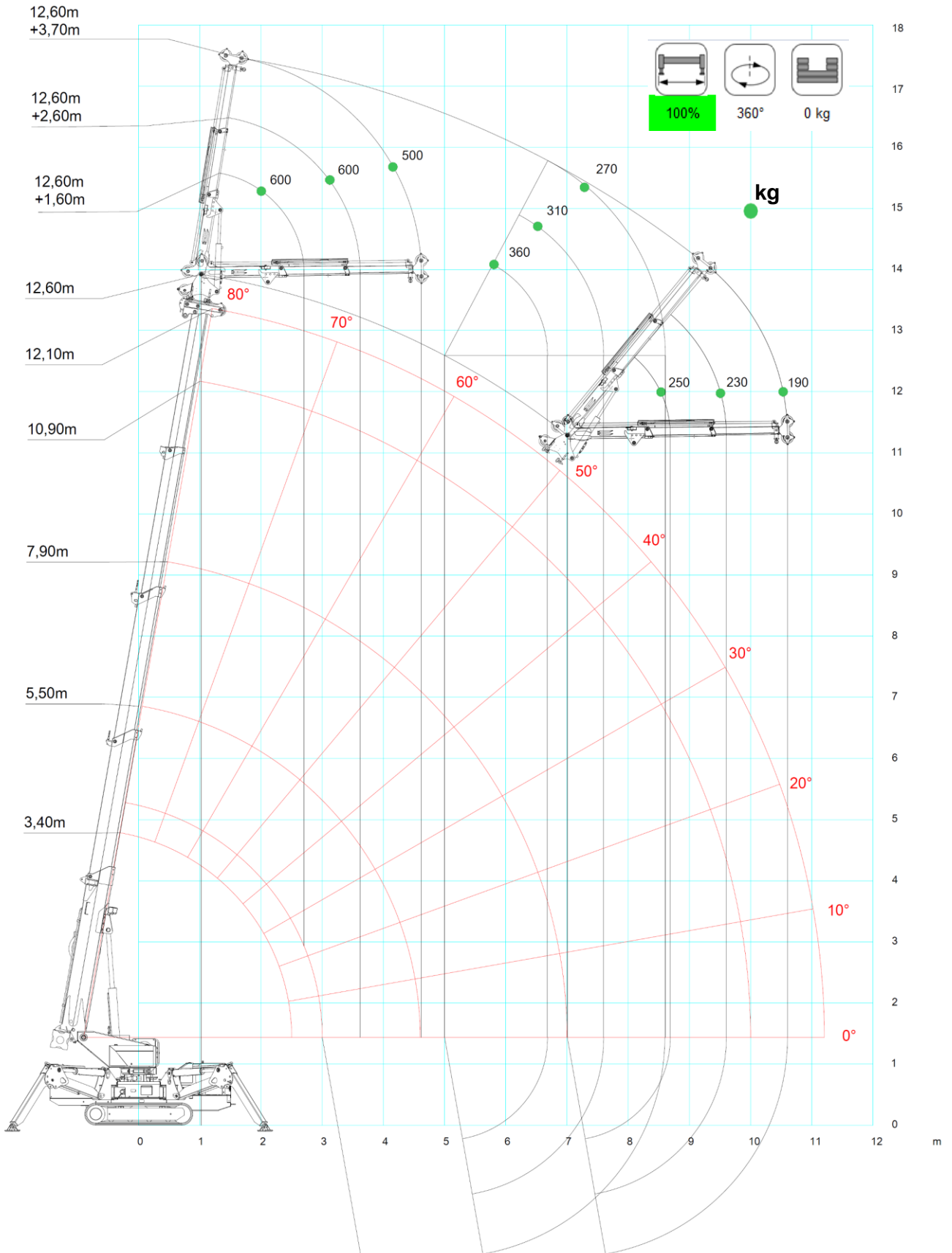

[m] [kg]					EN
	JIB600.2H	100%	360°	0 kg	
	1,6	2,1	2,6	3,1	3,7
1,0	600	600	600	520	500
3,0	600	600	600	520	450
4,0	600	550	470	420	380
5,0	360	330	310	290	270
6,0	250	240	230	210	190
7,1	250	240	230	210	190

SPX0527.00.02.200.1.05.15.A

[m] [kg]					EN
	JIB600.2H	>0km/h	0°-180°	0 kg	
	1,6	1,8			
2,0	200	100			
3,2	200	100			

SPX0527.00.03.200.1.05.15.A

## SPX527CDH-2 + JIB600.2H+Stinger

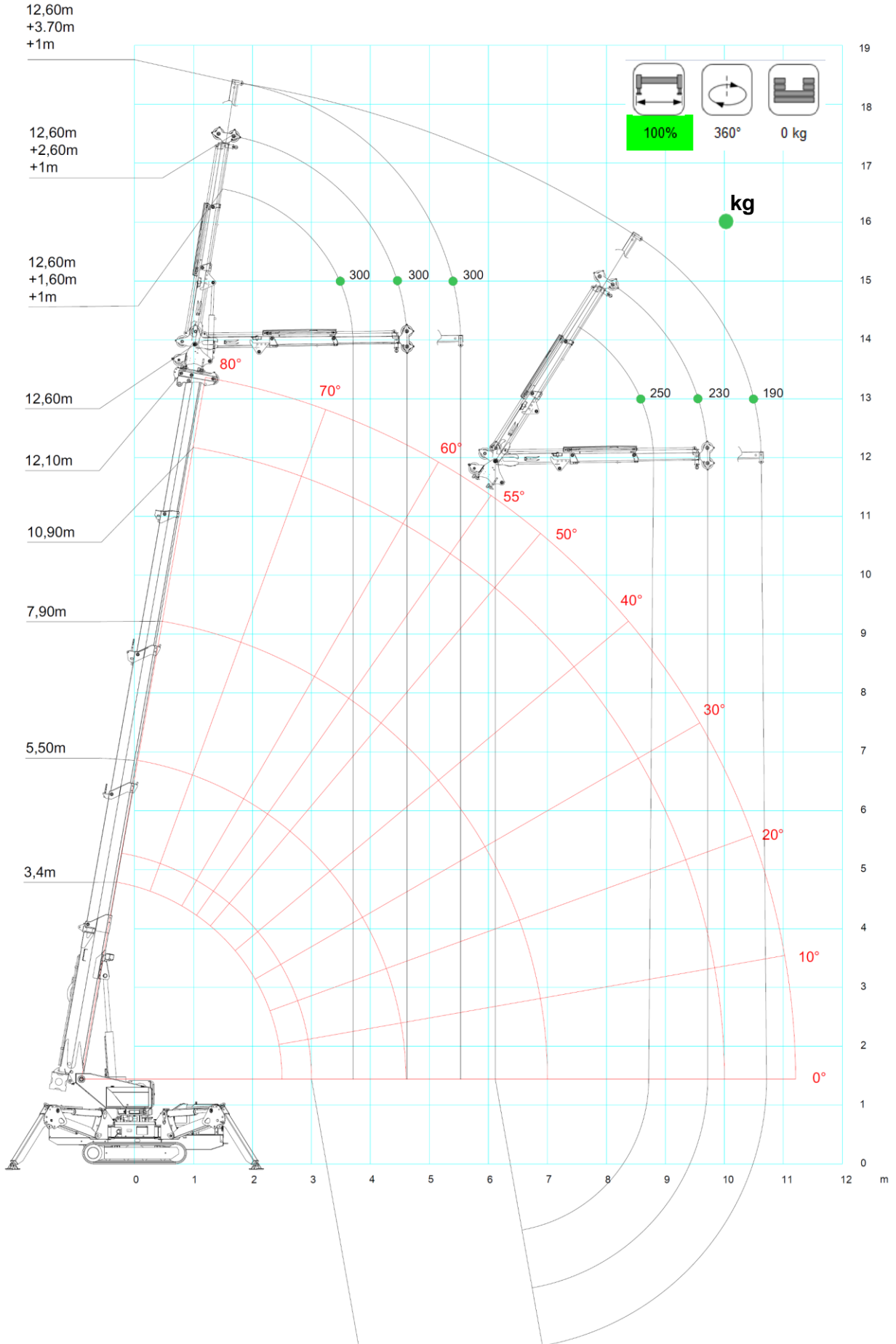

[m] kg					EN
	JIB600.2H +1Stinger	100%	360°	0 kg	
	2,1	2,6	3,1	3,7	
1,0	300	300	300	300	
3,0	300	300	300	300	
4,0	300	300	300	300	
5,0	300	300	290	270	
6,1	240	230	210	190	

SPX0527.00.02.201.2.05.15.A

[m] kg					EN
	JIB600.2H +1Stinger	>0km/h	0°-180°	0 kg	
	1,6	1,8			
2,0	200	100			
3,2	200	100			

SPX0527.00.03.201.2.05.15.A



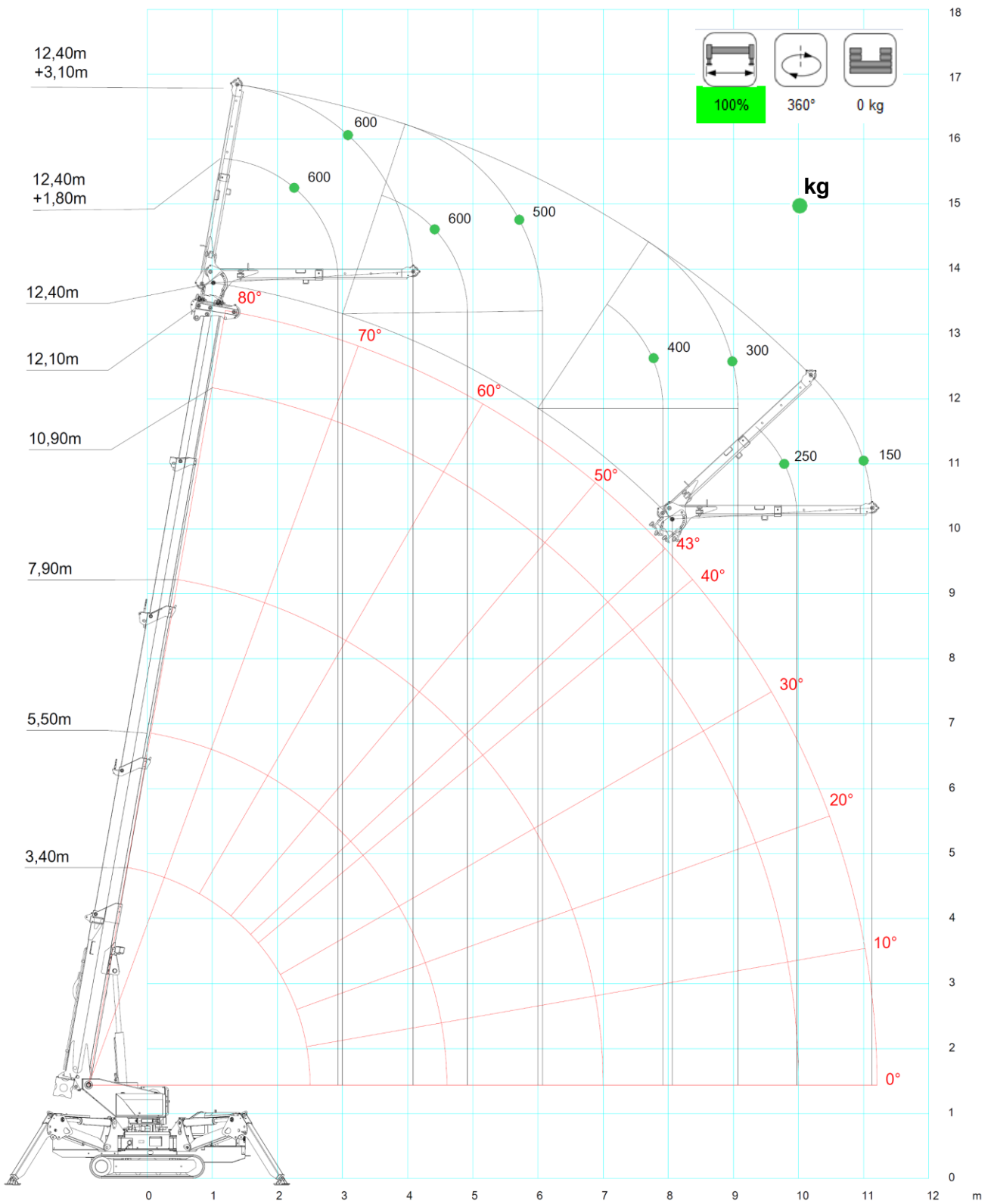

## SPX527CDH-2 + JIB600.1M

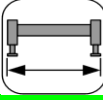
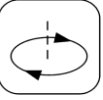
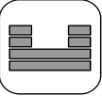
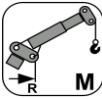

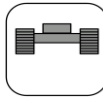

[m] [kg]					EN
	JIB600.1M	100%	360°	0 kg	
	1,8	3,1			
1,0	600	600			
3,0	600	500			
6,0	400	300			
8,1	250	150			

SPX0527.00.02.110.1.05.15.A

[m] [kg]					EN
	JIB600.1M	>0km/h	0°-180°	0 kg	
	1,8	3,1			
2,0	200	100			
3,2	200	100			

SPX0527.00.03.110.1.05.15.A

## SPX527CDH-2 + MR800.4-6+4P

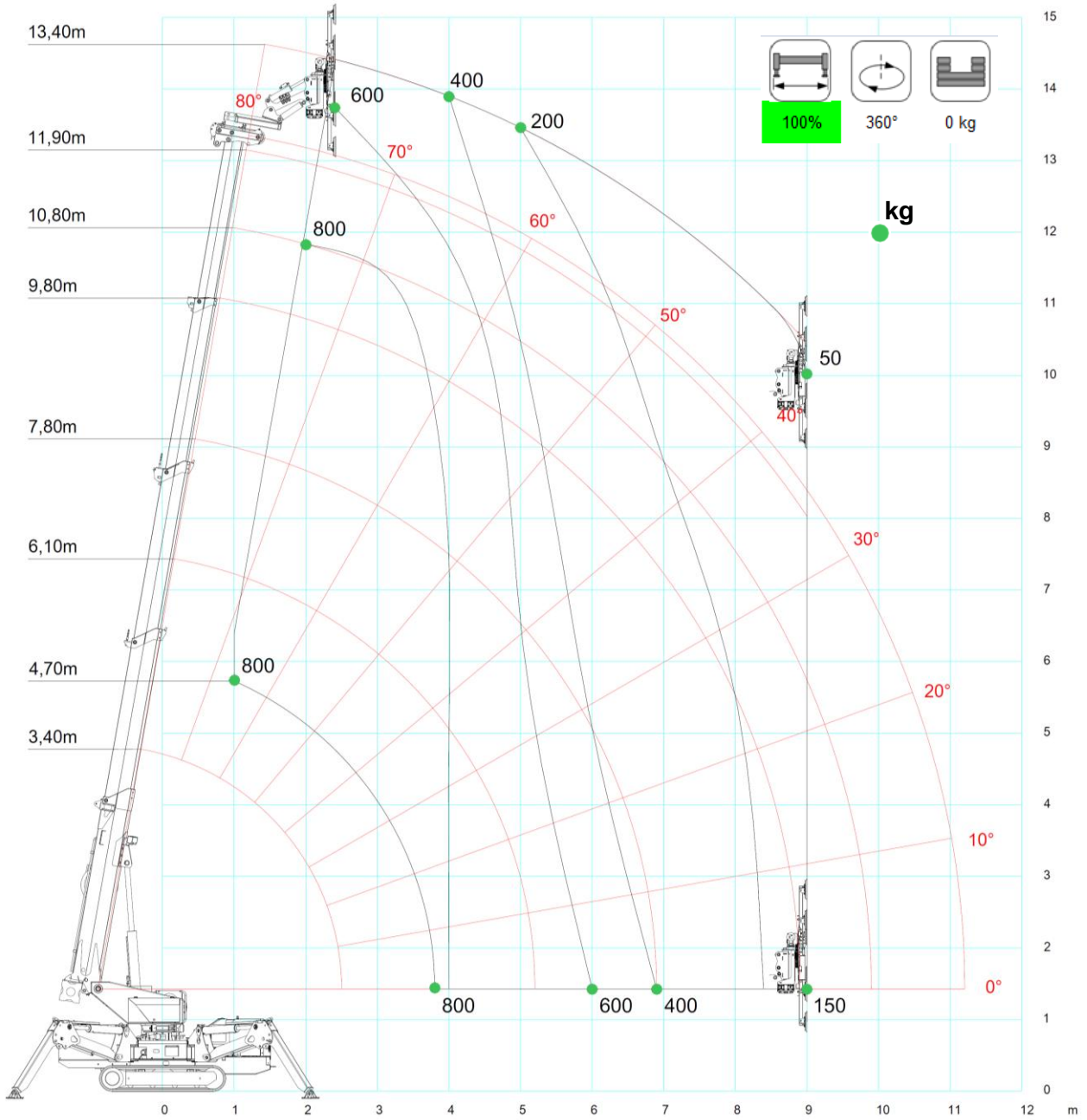

[m] [kg]					EN									
	MR800.4-6+4P	100%	360°	0 kg	4,7	5,4	6,1	6,8	7,8	8,8	9,8	10,8	11,9	13,4
1,0	800													
2,0	800	800	800	800	800	800	800	800	800	800	800	800		
3,0	800	800	800	800	800	800	800	800	800	800	800	800	700	500
4,0		800	800	800	800	800	800	800	800	800	800	700	600	400
5,0			700	700	600	600	600	600	500	500	400	400	300	200
6,0					400	400	400	400	400	300	300	300	200	100
7,0									300	200	200	200	100	50
8,0										200	100	100	50	50
9,0												50	50	50

SPX0527.00.02.430.0.01.16.A

[m] [kg]		>0km/h icon"/>			EN	
	MR800.4-6+4P	>0km/h	0°-180°	0 kg		
	4,7	5,4				
1,0	200	100				
4,0	200	100				

SPX0527.00.03.430.0.01.16.A

## SPX527CDH-2 + JIB301GR

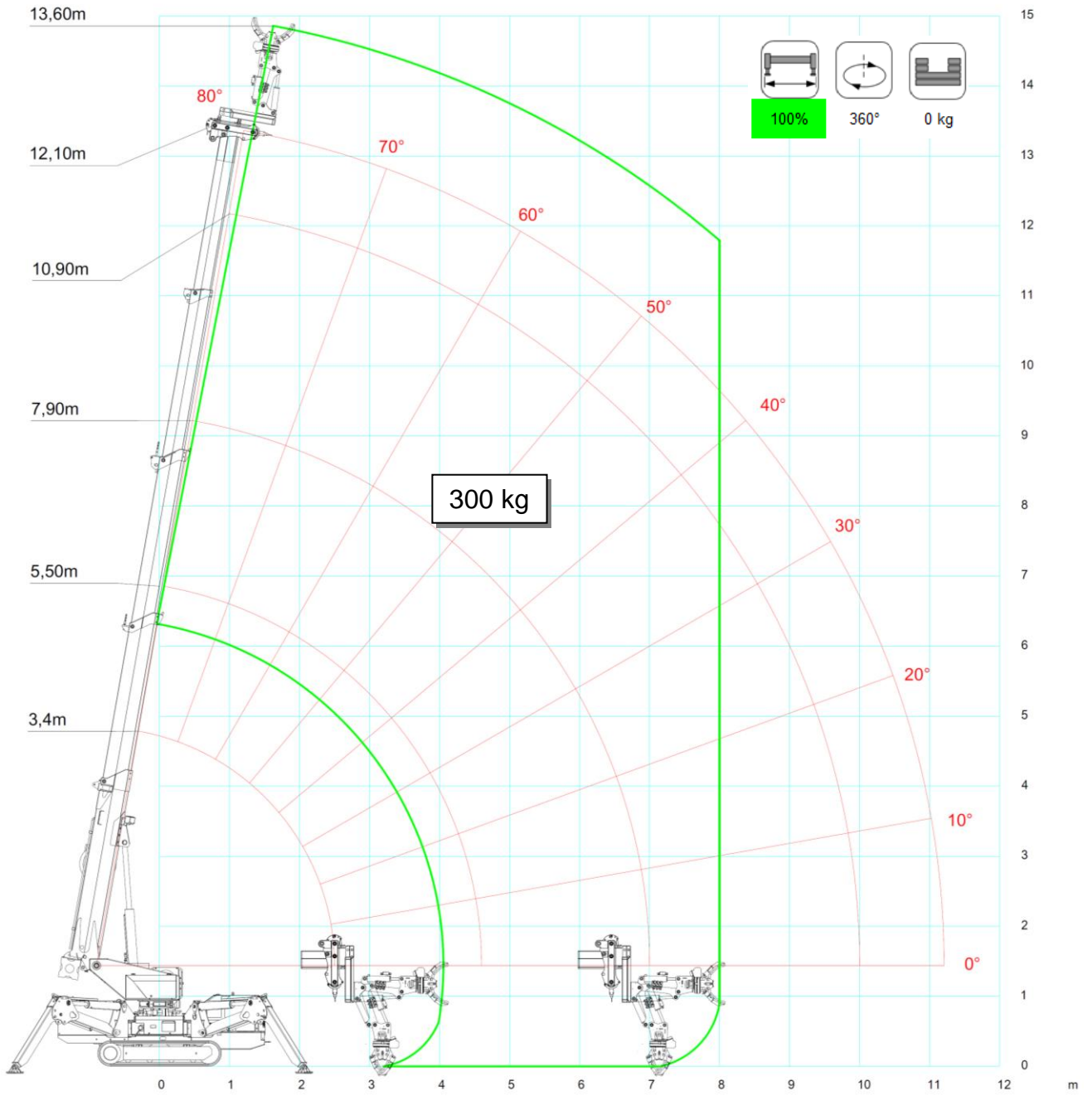



# SPX527CDH-2

## SPX527CDH-2 + JIB302GR

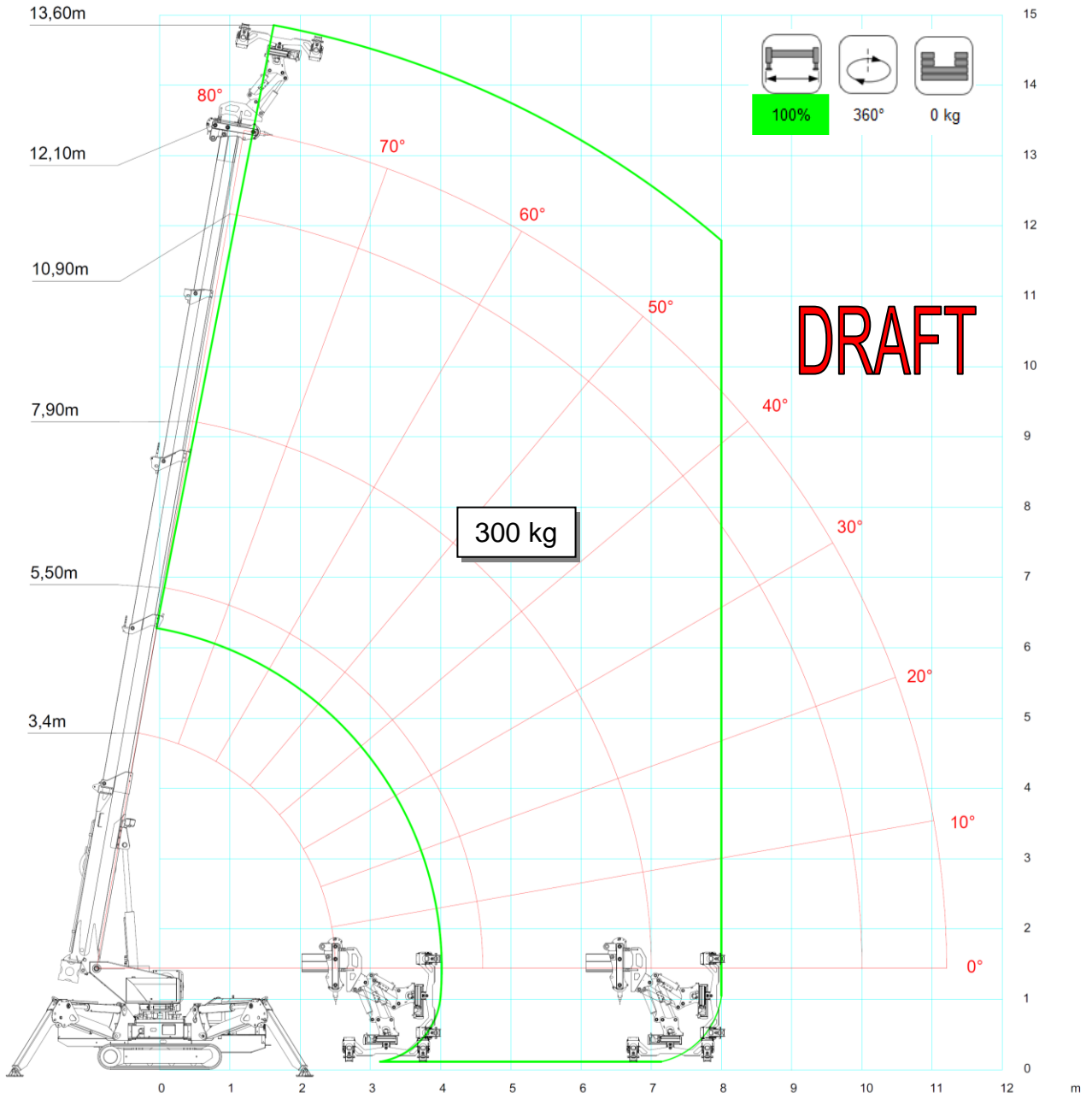

## ACCESSORIES

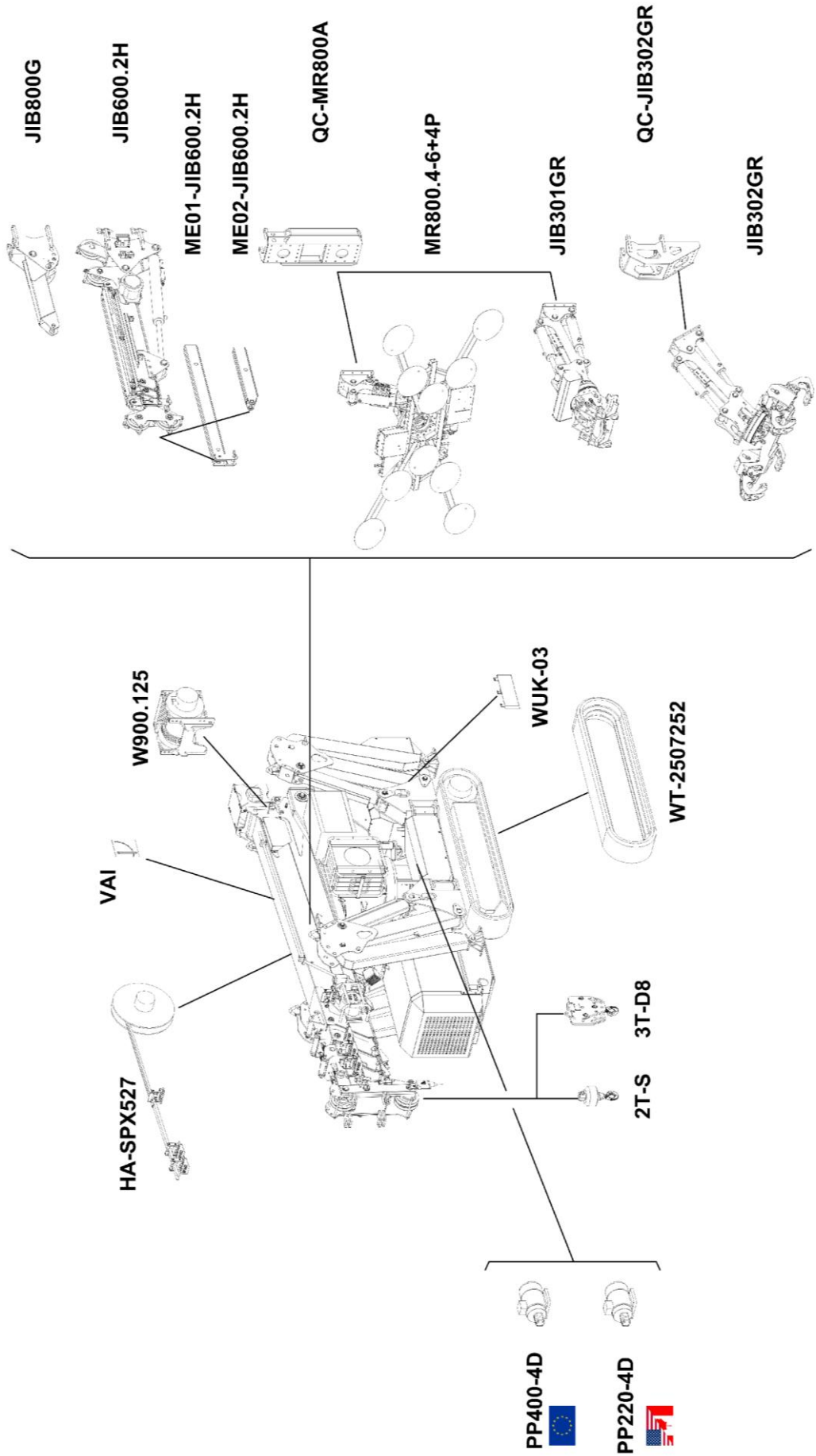

	STD	PC-02	PC-12
Boom, Covers & Outriggers	<input type="checkbox"/> RAL2004	<input type="checkbox"/> RAL_____	<input type="checkbox"/> RAL_____
Chassis, Frames & Tanks	<input type="checkbox"/> RAL7001	<input type="checkbox"/> RAL7001	<input type="checkbox"/> RAL_____

## ACCESSORIES FEATURES

### JIB 800G

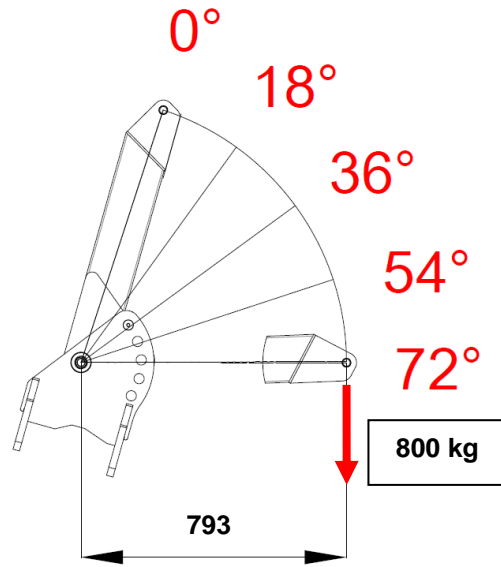

	kg
	26

### JIB 600.2H

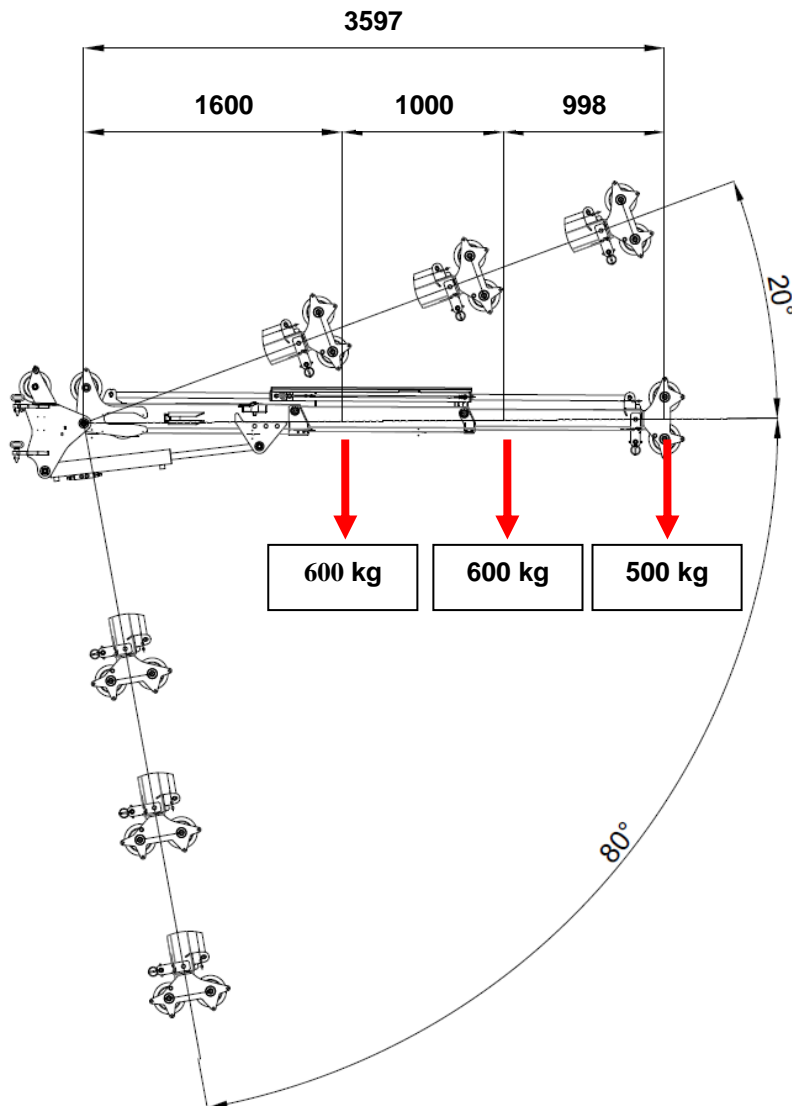

	kg
	210

## JIB 600.2H + STINGER

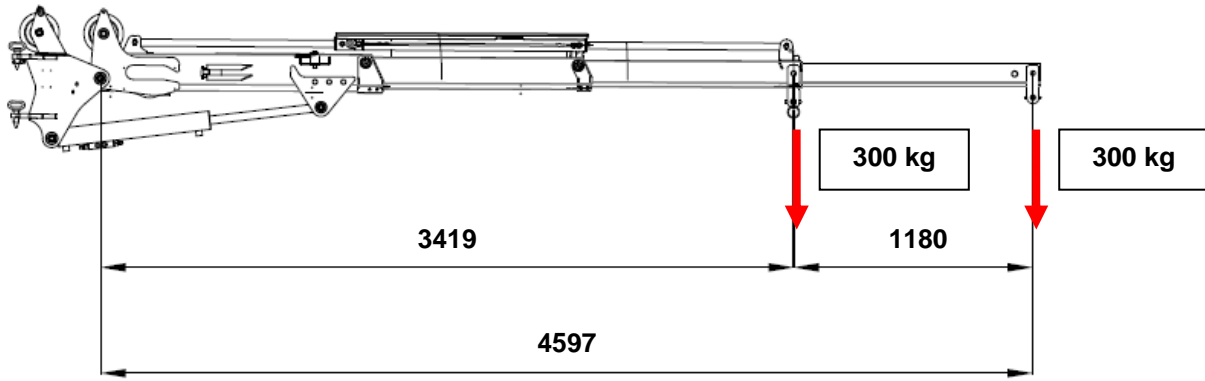

	kg
	215

## JIB 600.1M

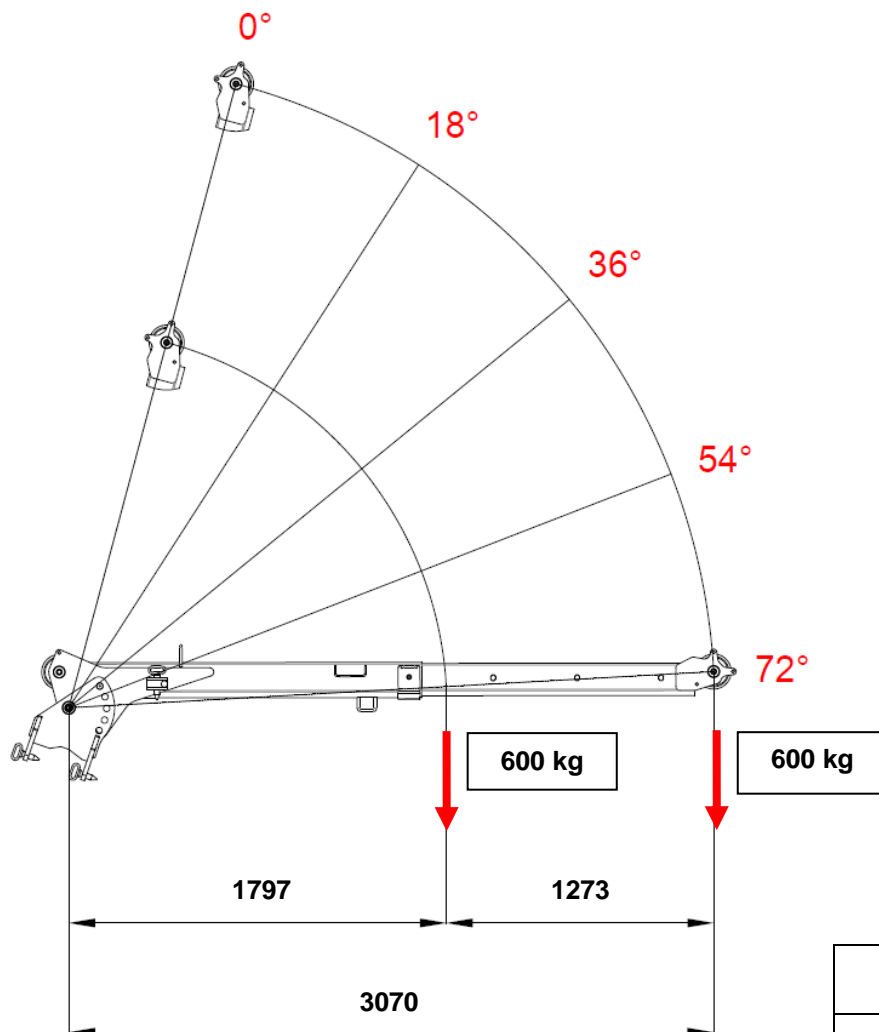

	kg
	98



## MR800.4-6+4P

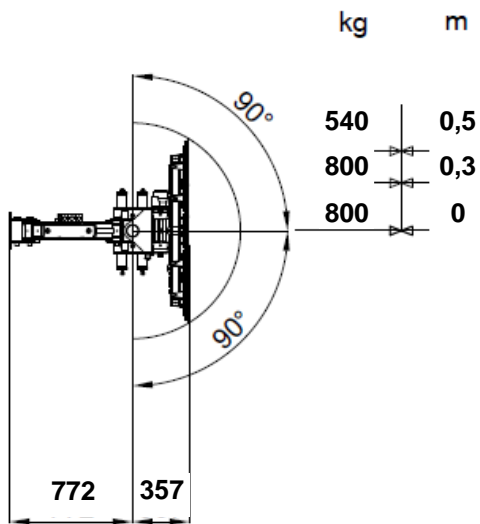
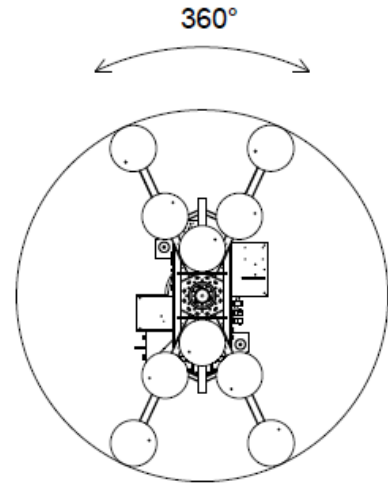
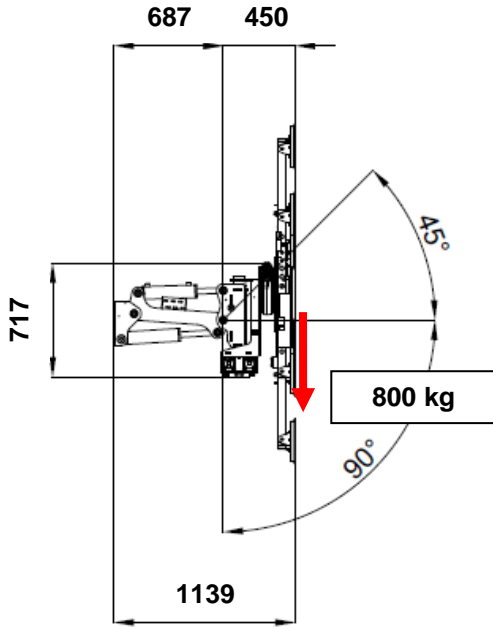



























	6	10	n°
	540	800	kg
	270	400	kg

	kg
	295



## SYMBOLS

	Weight		Chart Wheels		Engine		Jib length and angle
	Counterweight		Minipicker		Diesel Fuel		Jib Length
	Crane		Back Wheel Point Loading		Gasoline Fuel		Jib Radius
	Travel Speed		Front wheel Point Loading		Tank		Hydraulic Jib Length
	Gradeability		Travel Speed		Battery		Hydraulic Jib Radius
	Outrigger Load		Gradeability		Power		Mechanical Jib Length
	Track Loading		Working Radius		Boom Angle		Mechanical Jib Radius
	Outriggers Setup		Hookblock		Boom Length		Manipulator Length
	Ext Tracks Width		Slewing		Boom Radius		Manipulator Radius
	Chart On Tracks		Slewing Locked		Jib Hook Radius		Maximum inclination of the machinery
	Jib on board		Without jib on board		Standard		Stabilizing bar
	Horizontal boom angle		Number of vacuum pads		Factory max. load		Building site max. load

### Remarks referring to load chart

- The load charts are calculated according to EN 13000.
- For the calculation of the load charts at least a wind speed of 9m/s (33km/h) and regarding the load a sail area of 1m<sup>2</sup> per ton load and a wind resistance coefficient of 1.2 on the load have been taken into account. For lifting of loads with large sail areas and/or high wind resistance coefficients the maximum wind speed as stated in the load charts has to be reduced.
- Lifting capacities are given in kilograms.
- The weight of the hook blocks and hooks is part of the load and therefore it must be deducted from the lifting capacities.
- Working radii are measured from the slewing centre.
- The lifting capacities given for the telescopic boom apply if the folding jib is removed.
- Subject to modification of lifting capacities.



NOTES

A large, empty rectangular box with a thin black border, intended for handwritten notes.



NOTES

A large, empty rectangular box with a thin black border, intended for handwritten notes.



DEALER



JEKKO S.r.l. via Campardone, 1 Z.I. 31014 Colle Umberto (TV)  
Italy tel. +39 0438 1710083 fax +39 0438 1710123  
www.jekko.it - info@jekko.it