

SLT190 LINEAR POSITION TRANSDUCER

Innovation In Motion

INNOVATION IN MOTION

The SLT190 linear position transducer is designed to provide reliable, fit-and-forget position sensing within a compact transducer size for the most arduous operating environments. The transducer uses an innovative single coil inductive operating principle within a rugged, stainless steel housing and provides an analogue position signal proportional to the operating sleeve position. Offering one of the most cost-effective solutions for contactless absolute position sensing, this transducer is ideally suited to exterior mounting on off-highway vehicle systems, including military vehicles.

Impressive environmental capability

The SLT190 has been designed with 21st century applications in mind. The transducer can withstand operating temperatures from -40°C to +150°C and has been tested to withstand shocks to 10,000g. With an EMC Immunity of 100V/m, this transducer is ready for the harshest applications, such as steel and aluminium plants and power generating stations.

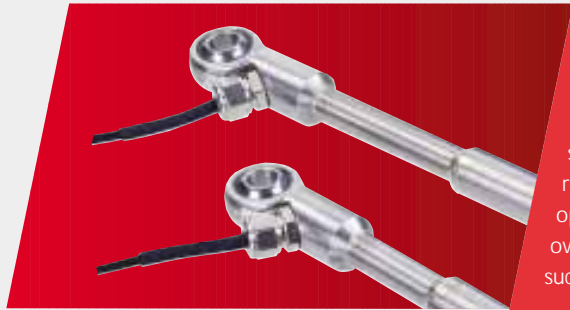

Choice of transducer strokes

The SLT190 is available with 14 different strokes from 25 to 500mm and has a short body-to-stroke-length ratio. This makes it ideal for the replacement of linear potentiometers in hostile operating conditions, whilst providing a cost saving over equivalent stroke length inductive transducers, such as LVDTs.

Features

- No contact between the sensing elements
- Compact body to stroke length
- Infinite resolution
- Absolute measurement
- Rugged stainless steel construction
- High temperature capability to +150°C (+302°F)
- CE approved
- Rapid despatch of any length

Benefits

- Virtually infinite life
- Reduced installation space
- All displacement will be sensed
- No loss of position on power down
- Maximum reliability under impact and vibration
- Maximum reliability in hostile environments
- Confidence in EMC performance
- Eliminates customer inventory



EMC Directive 2004/108/EC

The products detailed in this document have been tested to the requirements of EN61000-6-3 (Emissions) and EN61000-6-2 (Immunity).



Quality Assurance

Penny+Giles are accredited to BS EN ISO9001:2000. Quality is at the heart of all our systems ensuring the reliability of our products from initial design to final despatch.

Certificate No. LRQ 0924881

SLT190 LINEAR POSITION TRANSDUCER



Rugged mounting style

The patented operating principle of the SLT190 position transducer uses a core moving within the transducer body to supply the signal proportional to outer sleeve displacement. The outer sleeve design is captive, with the sleeve and transducer bodies both having a rugged M8 self-aligning, stainless steel bearing included for simple installation. The M8 size allows the transducer to be mounted on an 8mm or 5/16in mounting pin.

Separate signal conditioning

To minimise the transducer size and the impact on the overall system, we provide separate signal conditioning electronics (EICT or EICTM) housed in rugged IP66 or IP68 rated enclosures. The electronics module can be located up to 10m away from the transducer, well away from any hostile conditions (vibration, mechanical impact, temperature) that the position transducer may encounter during operation. The result is a more reliable transducer solution, easily installed and adjusted and more flexible in the choice of outputs available – including voltage, current and digital PWM.



Total reliability

The SLT190 provides a highly reliable solution for absolute position sensing in a variety of applications. The contactless operating principle (with no electrical sliding contacts) allows a fit-and-forget installation so that zero maintenance programs can be incorporated within plant or equipment service schedules.

World leading availability

The SLT190 has been 'designed for manufacture' enabling assembly in a state-of-the-art manufacturing cell. This means that we can supply any one of the 14 different stroke lengths in a matter of days from ordering. This allows OEMs to reduce or eliminate their inventory, and call on Penny+Giles to supply 'on demand'.

Performance assured

Penny+Giles' product development process includes exhaustive qualification testing to ensure that performance specifications published in our product brochures and technical data sheets are backed by real-life test evidence. This is our assurance to you that our designs have been tested at these parameters.

SLT 190 LINEAR POSITION TRANSDUCER

PERFORMANCE

ELECTRICAL

Electrical stroke range E	mm	25 to 500
Stroke increments	mm	25 to 200 in 25mm increments 250 to 500 in 50mm increments
Non-Linearity*	%	Enhanced - typically less than $\pm 0.2\%$ of total stroke, $\pm 0.25\%$ maximum (code A) Standard - typically less than $\pm 0.4\%$ of total stroke, $\pm 0.5\%$ maximum (code B)
Resolution		Virtually infinite
Temperature coefficient	ppm/°C	< ± 100 ppm of electrical stroke/°C (+20 to +60°C) < ± 200 ppm of electrical stroke/°C (-20 to +100°C) < ± 300 ppm of electrical stroke/°C (-20 to +150°C)
Insulation resistance		Greater than 50M Ω at 50Vdc

*Non-linearity is measured using the Least-Squares method on a computerised calibration system

MECHANICAL

Mechanical stroke range	mm	Electrical stroke +3mm overstroke at each end
Mounting		via M8 stainless steel rod end bearings. Suitable for mounting on 8mm or 5/16in bolts
Operating force	gf	< 500 in horizontal plane (vented sleeve)
Shaft velocity - maximum	m/s	5 (see EICT performance for frequency response)
Weight	g	see dimensions on page 5

ENVIRONMENTAL

Protection class		IP67
Operational temperature	°C	-40 to +150
Storage temperature	°C	-50 to +150
Life		Contactless - no limitation to electrical life. Mechanical life is tested to 100 million operations (5x10 ⁶ cycles), actual service life is dependant on installation and application.
Vibration		RTCA/DO-160E 10Hz to 2000Hz, 11.23g (rms) - radial axis only
Shock		Survival to 10000g - radial axis
EMC Immunity level		Transducer can withstand a threat of 100V/m

The performance specified is only valid when the SLT190 is operated in conjunction with the signal conditioning unit - model EICT or EICTM.

OPTIONS

Non-linearity		Standard (code B $\pm 0.5\%$ max), or Enhanced (code A $\pm 0.25\%$ max) can be specified
Extended cable length		1m or 6m output cable can be specified

AVAILABILITY

All configurations can be supplied within ten days from the factory

ORDERING CODE

	SLT190///	
Stroke range E in mm	_____	_____	_____	_____	01 = 1m cable
Non-linearity	A = $\pm 0.25\%$	_____	_____	_____	06 = 6m cable
	B = $\pm 0.50\%$				

SIGNAL CONDITIONING

Input voltage	Vdc	See page 6 for full EICT module performance and dimensions +10 to +60 nominal
Output voltage		
standard	Vdc	0.5 to 4.5
options	Vdc	0 to 5, 0 to 10, ±2.5, ±5, ±7.5, ±10 (using Voltage Module VM output option card)
Output current - option	mA	4 to 20 (using Current Module CM output option card)
Output PWM		TTL level compatible signal with a 10-90% duty cycle proportional to transducer displacement (using Pulse Width Modulation PWM output option card)

The transducer is supplied with a Sensor Calibration Module Card (**SCMC**) which is calibrated to match the transducer electrical stroke. This card must be inserted into the **EICT** signal conditioning unit before operation. Full details on installation and set-up are included in the manual supplied with the EICT module.

DIMENSIONS

Note: drawings not to scale

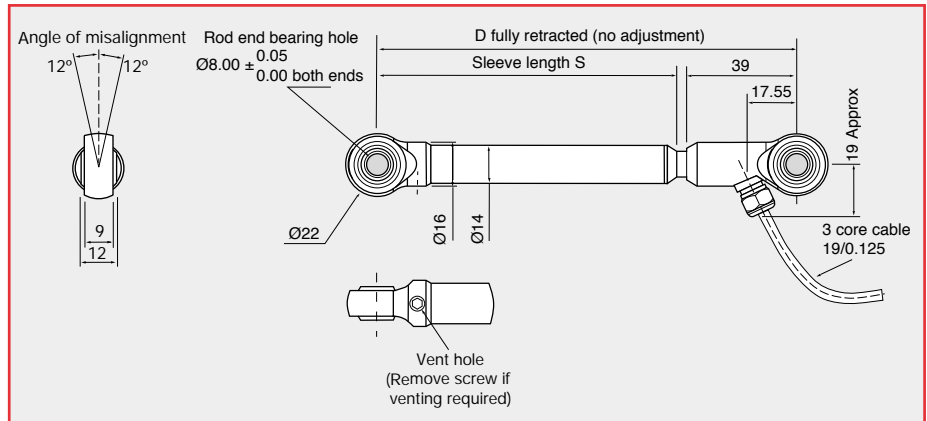

Electrical stroke E	mm	25	50	75	100	125	150	175	200	250	300	350	400	450	500
Mechanical stroke M	mm	31	56	81	106	131	156	181	206	256	306	356	406	456	506
Sleeve length S	mm	132	157	182	207	232	257	282	307	357	407	457	507	557	607
Distance between centres D	mm	175	200	225	250	275	300	325	350	400	450	500	550	600	650
Approximate weight	g	239	258	277	296	314	333	352	370	408	446	483	520	558	595

ELECTRICAL CONNECTIONS

3 core cable: FEP sheathed 1m or 6m long with PTFE insulated 19/0.125 cores. 90% braided screen.

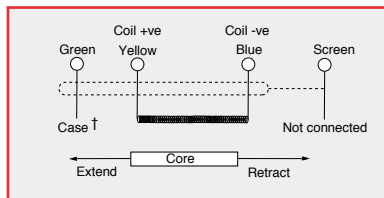

Recommended cable minimum bend radius is 10mm

† The Green wire is internally connected to the transducer case. However, due to the construction of the transducer external moving parts, the Green connection should not be used as a ground connection.

EICT SIGNAL CONDITIONING MODULE

The EICT signal conditioning module has been specifically designed to operate the SLT190 and ICT range of contactless linear position transducers. This module incorporate a high performance circuit that drives the transducer and provides a choice of output signals with zero and span adjustment for simple user configuration. The module can be supplied in a choice of enclosures, with sealing to IP66 or IP68 protection.

PERFORMANCE

Supply voltage, unregulated Vdc

limited to 13.5 min. on certain ranges - see options table

Supply current mA

Output voltage signal Vdc

Output current signal mA

Output PWM signal

Output ripple mVrms

Output load Ω

Frequency response Hz

Line regulation

Power on settlement

Output adjustment range

zero adjustment

gain adjustment

Operational temperature °C

Storage temperature °C

Temperature stability ppm/°C

EMC Immunity level

EN61000-6-2: 10kHz to 1GHz

Transducer types

Mechanical housing

Weight maximum g

10 - 60 or $\pm(10 - 30)$ for standard output voltage range (**EICT** only)
 $10^1 - 30$ or $\pm(10^1 - 30)$ for extended output voltage range (**VM** card fitted)
 10 - 30 or $\pm(10 - 30)$ for current output (**CM** card fitted) or pulse width modulated output (**PWM** card fitted)
 10 maximum (19 with **VM** card fitted, 12.6 plus output current with **CM** card fitted, 13 with **PWM** card fitted)
 0.5-4.5 See details on page 7 for additional output options
 4-20 See details on page 7 for options
 TTL level compatible signal with a 10-90% duty cycle. See details on page 7
 < 5
 10k minimum (resistive to 0V line)
 30 (-3dB) [equivalent to 5mS output lag]
 < 0.001% output span/Volt
 Within 0.25% of final output in less than 300 milliseconds

-10 to 60% of span

40 to 110% of span

0 to +70

-40 to +85

200 (300 if VM card fitted)

Threat 100V/m : derangement < 0.05% FS (**EICTM** module, adjacent to transducer)

Threat 10V/m : derangement < 0.05% FS (**EICT** module, 1m cable)

Will only operate Penny+Giles SLT190 and ICT range of transducers

EICT - corrosion resistant plastic enclosure sealed to IP66, with detail to fit rail DIN EN50022 or EN50035 or bulkhead mount via four M5 screws.

EICTM - powder coated metal enclosure sealed to IP68 with bulkhead mounting only.

105 (250 for EICTM)

Maximum recommended distance between transducer and EICT module is 10m.

OUTPUT CHARACTERISTICS

EICT standard unit 10 - 60Vdc supply

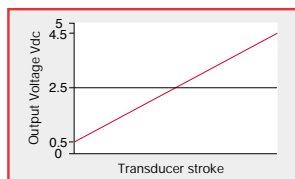

EICT with VM card fitted 10 - 30Vdc supply

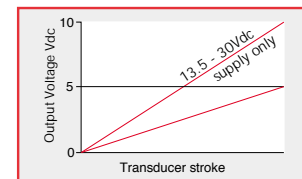

EICT with CM card fitted 10 - 30Vdc or $\pm(10 - 30)$ Vdc supply

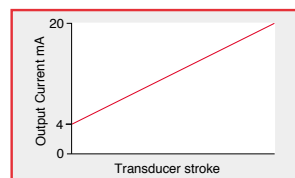

EICT with VM card fitted 10 - 30Vdc or $\pm(10 - 30)$ Vdc supply

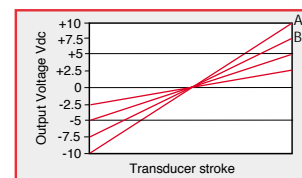

Note: A and B outputs only available with a $\pm(13.5 - 30)$ Vdc supply

Notes:

- The SLT190 transducer is supplied with a Sensor Calibration Module Card (SCMC) which is calibrated to match the transducer electrical stroke. This card must be inserted into the EICT signal conditioning unit before operation. The EICT is user configurable for input and output options.

Full details on installation and set-up are included in the manual supplied with the EICT module.

OUTPUT OPTIONS

Output option	Supply voltage range Vdc Single or (Dual) supply	EICT	EICT with VM option card	EICT with CM option card	EICT with PWM option card
0.5 - 4.5Vdc	10 - 60 or ±(10 - 30)	✓	N/A	N/A	N/A
0 - 5Vdc	10 - 30 or ±(10 - 30)	N/A	✓	N/A	N/A
0 - 10Vdc	13.5 - 30 or ±(13.5 - 30)	N/A	✓	N/A	N/A
±2.5Vdc	10 - 30 or ±(10 - 30)	N/A	✓	N/A	N/A
±5Vdc	10 - 30 or ±(10 - 30)	N/A	✓	N/A	N/A
±7.5Vdc	13.5 - 30 or ±(13.5 - 30)	N/A	✓	N/A	N/A
±10Vdc	13.5 - 30 or ±(13.5 - 30)	N/A	✓	N/A	N/A
4 - 20mA	10 - 30 or ±(10 - 30)	N/A	N/A	✓	N/A
TTL (10-90%)	10 - 30 or ±(10 - 30)	N/A	N/A	N/A	✓
Slope reversal		✓	✓	✓	✓

PWM output signal

Output frequencies	Hz	100, 130, 310, 1000 (user selected)
Frequency accuracy	%	±10
Output levels	Vdc	LOGIC HIGH 4.5 ±0.5 LOGIC LOW <0.4
Rise/Fall time	µS	<2 with 1nF. load capacitance
Output range	%	10 (zero) to 90 (span)

TTL level compatible signal with a 10-90% duty cycle

100, 130, 310, 1000 (user selected)

±10

LOGIC HIGH 4.5 ±0.5

LOGIC LOW <0.4

<2 with 1nF. load capacitance

10 (zero) to 90 (span)

Continual development of output options means we are working on additional **EICT** module output options. Please ask for details

DIMENSIONS

Note: drawings not to scale

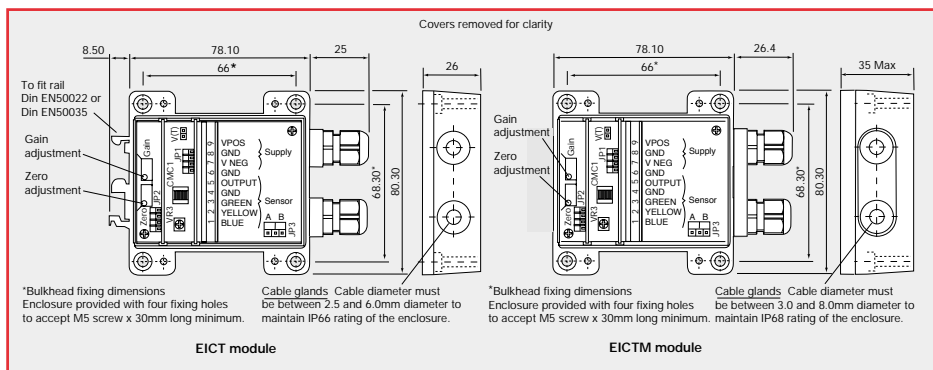

ELECTRICAL CONNECTIONS

Screw terminals

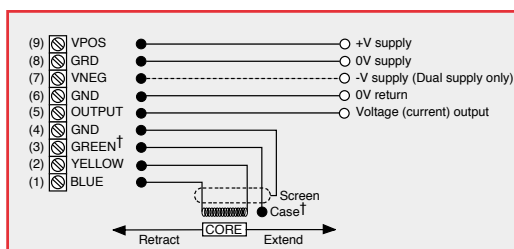

Misconnection of the supply may cause permanent damage

† The Green wire is internally connected to the transducer case. However, due to the construction of the transducer external moving parts, the Green connection should not be used as a ground connection.

Note: refer to the EICT set-up guide for details on how to connect to a split rail power supply.

AVAILABILITY

Normally available from stock

ORDERING CODES

EICT - module with 0.5 to 4.5Vdc output, IP66 protected plastic housing

EICTM - module with 0.5 to 4.5Vdc output, IP68 protected metal housing

ACCESSORIES

order separately

VM - voltage module output option card

CM - current module output option card

PWM - pulse width modulation output option card