

Lifting, tilting, turning...



Material handling

Lift and tilt table HKT 1500

Container lifter BN-HK

Container tilter BN, BN-SH, BN-SG

Adjustable stand KS

Box tilting table NT

Lift table for tools WZW

Drum lifter

Drum turner

Drum gripper

Appliances with 90° tilt

Dustbin tipper MT 240

Handy

Assembly lift table M

Low-profile lift table

Ergo-E

Ergo-G

Column lift SH

Pallet transfer station PAS



Lift and tilt table HKT



Container tilter BN BN

Content

4-5	Lift and tilt table HKT 1500	15	Appliances with 90° tilt
6-7	Container lifter BN-HK	16	Dustbin tipper MT 240
8-9	Container tilter BN Container tilter BN-SH	17	Handy
10	Container tilter BN-SG	18-19	Assembly lift table M
11	Adjustable stand KS Box tilting table NT	20-23	Low-profile lift tables Ergo-E Ergo-G
12	Lift table for tools WZW Drum gripper	24-25	Column lift SH
13-15	Drum lifter Fassboy Drum turner	26-27	Pallet transfer station PAS



Drum lifter



Handy

GRUSE gets things moving

GRUSE has been engineering and building machinery and equipment since 1869.

Today GRUSE specialises in the design and manufacture of lifting and conveying equipment for in-house transportation and material management systems.

Increasingly, ergonomics and work safety play an instrumental role in achieving faster and more efficient production. Over a dozen design experts at GRUSE are involved in the development of solutions for various lifting, tilting and turning operations designed ultimately to make life easier for operators. The functionality, safety, stability and operational ease of GRUSE's lifting and handling systems have proved their worth over the past 25 years and they are undergoing continuous improvement.

Consult one of our employees for advice. We can customise a wide range of products to meet your specific needs. For more information, see: www.gruse.de



Lift an tilt table HKT 1500



Lift and tilt table HKT 1500 (Ill. features customized tabletop)

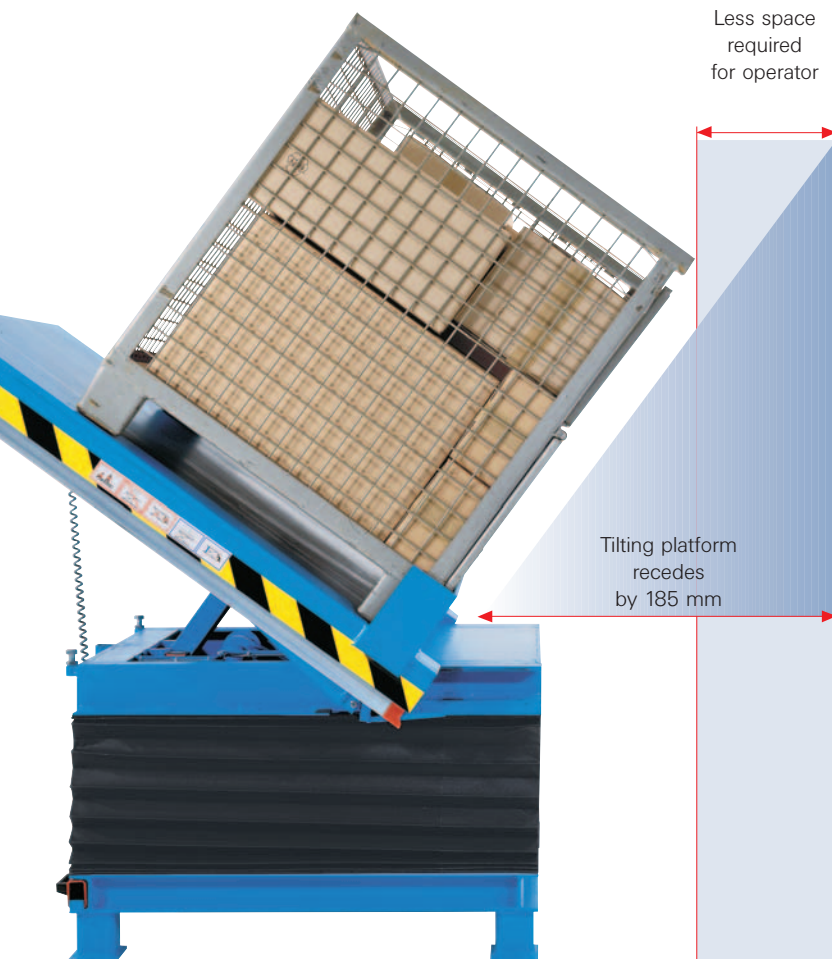

Tilting heavy loads

GRUSE's lift and tilt table is a special space-saving device for industrial and commercial operations. It is best suited for work areas in which products or materials are to be loaded and handled at ergonomic heights. A specific feature of this lift and tilt table is that the tilting platform recedes by 185 mm. Its compact design makes it suitable for heavy-duty containers with a weight of 1500 kg.

Standard fittings

- I Operating voltage 400 V
- I Control voltage 230 V
- I Sub-table adjustable in height, 400 mm
- I Tilting top with tilting platform
- I Tilt angle 35° in approx. 35 seconds
- I Bellow provides protection
- I Tilt function available in all lift positions
- I Tabletop made of smooth sheet metal
- I Hose failure protection
- I Safety rail at tabletop (3 sides)
- I Maintenance-free scissor axle bearing
- I Inspection strut
- I Dead man's control unit with manual push button control and emergency stop on 3 m cable

Details

The tilting platform recedes by 185 mm and is thus particularly space-saving and user-friendly. The ideal ergonomic tilting position can be adjusted to the operator's individual needs.

Product overview



Details

A forklift is used to move the lift and tilt table plus container. The container can be loaded with a high-lift truck. The load-bearing surface of the tilting platform is designed for skeleton container sizes of 1,000 by 1,400 mm.

Lift and tilt table

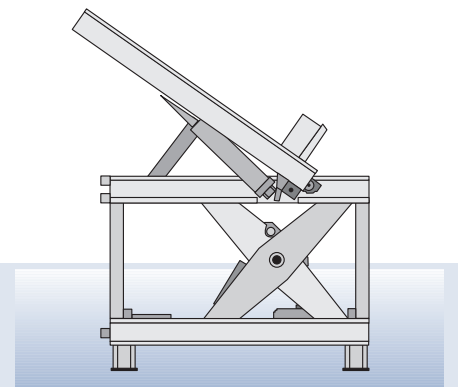

Lift and tilt table

HKT 1500

Load-bearing capacity kg	Tilt angle °	Usable stroke mm	Tabletop mm	Sub-frame mm	Lifting time approx. sec.	Power kW	Weight approx. kg	Type
1500	35	370 - 770	1000 x 1400	970 x 900	23	1,1	1300	HKT 1500

Container lifter BN-HK

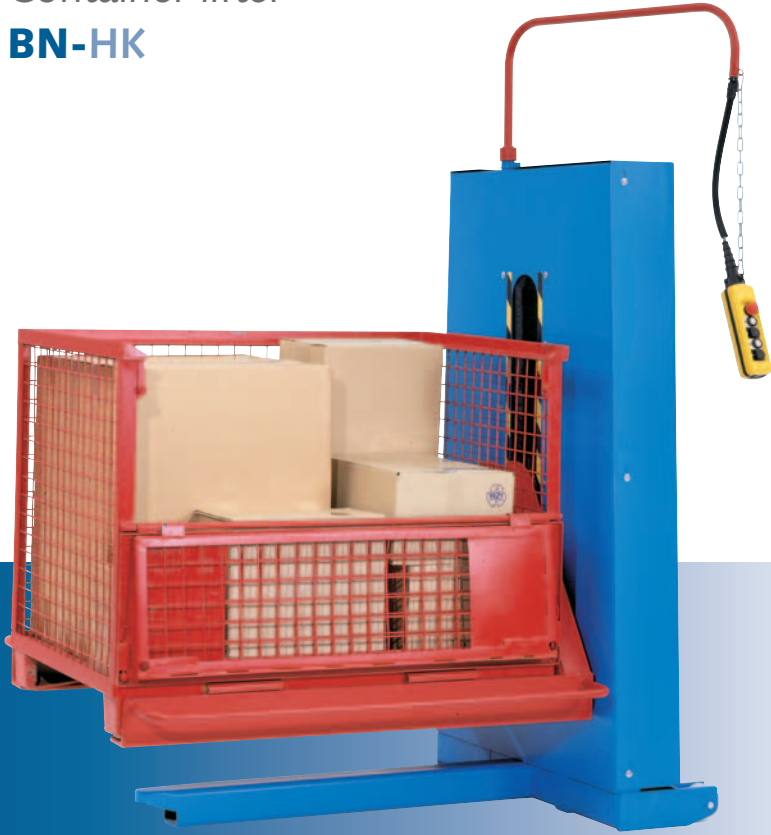

Container lifter BN-HK



Lift and tilt in one single operation

Container lifter BN-HK

Operating at ergonomic heights – lifting and tilting in one single operation. This technically sophisticated assistant has been designed for workstations where material has to be removed from skeleton containers. The BN-HK 1500 KE lift and tilt function is set in motion by pushing one single button.

1. Lift
2. Tilt (prism guided)
3. Tilt angle up to 35° (standard)
4. Further lift to desired level

The BN-HK 1500 KE or HE can tilt to the left or to the right. Please indicate the desired direction.

Independently of the lifting function, the BN-HK 1500 HE tilts hydraulically to one side and the BN-HK 1500 HB to either side.

Standard fittings

- | Load-bearing capacity up to 1500 kg
- | Lift and tilt in one single operation (BN-HK 1500 KE only)
- | Tilt angle up to 35°
- | Operating voltage 400 V
- | Control voltage 230 V
- | Loading with fork lifts or pallet trucks
- | BN-HK 1500 HE and KE tilt either to the right or to the left (easy to retrofit from right or left side)

On request a lever roller can be supplied for cases where it is necessary to have a transportable appliance.

Product overview

BN-HK

1. Lift
2. Tilt

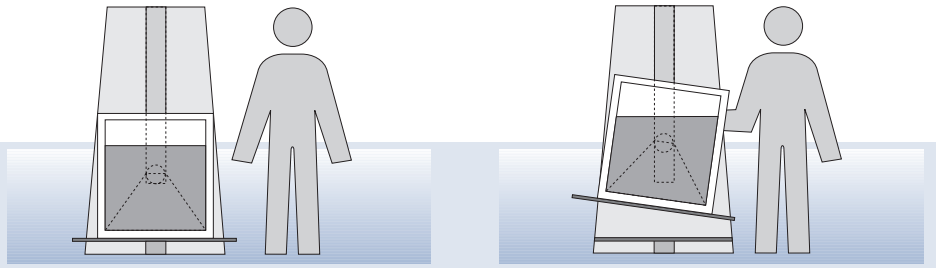

3. Tilt angle up to 35°
4. Desired height

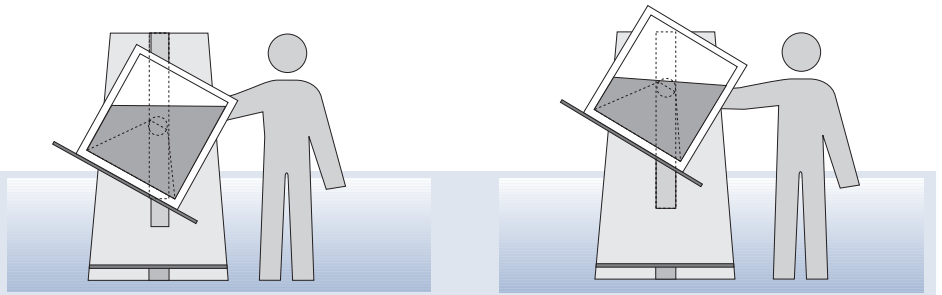

Container lifter

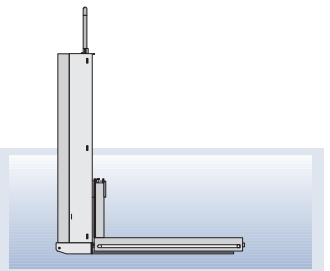

Container lifter

BN-HK

Load-bearing capacity kg	Tilt angle °	Voltage V	Tilt	Power kw	Weight approx. kg	Type
1500	35 one side	400	prism guide	1,1	520	BN-HK 1500 KE
1500	35 one side	400	hydraulic	1,1	530	BN-HK 1500 HE
1500	35 either side	400	hydraulic	1,1	550	BN-HK 1500 HB

Container lifter BN, BN-SH



Container tilter with foot pump

Container tilter BN-SH



Tilt angle up to 90°

The container tilter is designed for heavy containers and skeleton containers. With a tilt angle of up to 90° it allows for easy unloading of a container without the operator having to bend over. Depending on individual requirements it can be supplied with

1. electro-hydraulic pump or
2. foot pump.

Standard fittings

- I Load-bearing capacity of 1000 or 1500 kg
- I Tilt angle 90° max.
- I Operating voltage 12V, 230V, 400V
- I Wheels with Ø 200/85 mm
- I Dimensions: length 1230 mm, with 740 mm, fork length 820 mm, fork width 550 mm

BN-SH

The container tilter BN-SH is the stationary version of the BN. It tilts to an angle of up to 90°. Instead of featuring load-bearing forks it is equipped to receive 900 x 1250 mm skeleton boxes. Fork lift trucks are used for loading.

Standard fittings

- I Load-bearing capacity of 1000 or 2000 kg
- I Tilt angle 90° max.
- I Operating voltage 400 V
- I Control voltage 230 V
- I Side casing as safety feature

Product overview

BN, BN-SH

Container lifter BN, BN-SH

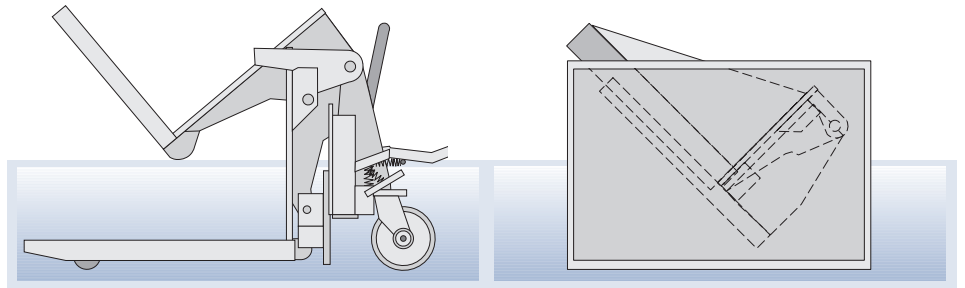

Container lifter

BN, wheeled

Load-bearing capacity kg	Tilt angle °	Voltage V	Lifting time approx. sec.	Weight approx. kg	Type
500	90	foot pump	-	195	BN 500
500	90	400 V	12	205	BN 500 E/400 V
500	90	230 V	16	205	BN 500 E/230 V
500	90	12 V/55 Ah	12	205	BN 500 E/12 V
1000	90	foot pump	-	200	BN 1000
1000	90	400 V	15	210	BN 1000 E/400 V
1000	90	230 V	20	210	BN 1000 E/230 V
1000	90	12 V/55 Ah	17	210	BN 1000 E/12V
1500	90	400 V	25	230	BN 1500 E/400 V

Accessories

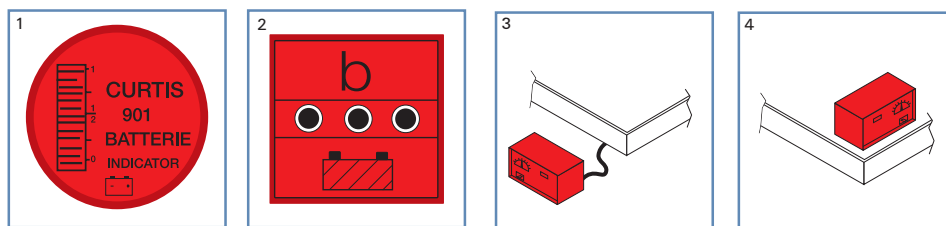

- 1 Battery capacity indicator with unit switch, for 12 V-units, by Curtis
- 2 Battery capacity indicator without unit switch, for 12 V-units
- 3 External battery charger (automatic) charging current 7 amps. max.
- 4 Integrated battery charger (automatic), charging current 10 amps. max.

Container lifter

BN-SH

Load-bearing capacity kg	Tilt angle °	Loading height mm	Container size mm	Voltage V	Lifting time approx. sec.	Power kW	Weight approx. sec.	Type
1000	90	90	900 x 1250	400	13	1,1	520	BN-SH 1000
2000	90	90	900 x 1250	400	32	1,1	580	BN-SH 2000

Container lifter BN-SG



Tilt from 35° to 45°

The BN-SG container tilter features receiving platforms for loads of 1000 or 2000 kg. It is easy to use and allows operators to work at ergonomically convenient heights without having to bend over.

Container tilter BN-SG

Standard fittings

- | Load-bearing capacity up to 1000 or 2000 kg
- | Tilt angle 35° max.
- | Operating voltage 400 V
- | Control voltage 230 V
- | Platform 1400 x 1000 mm
- | Safety rail
- | Load with fork lifter

Container tilter

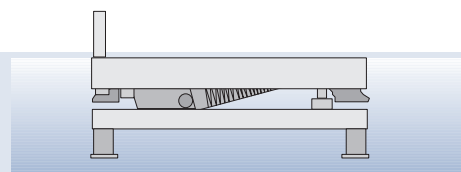

Container lifter BN-SG

Load-bearing capacity kg	Tilt angle °	Loading height mm	Tabletop mm	Voltage V	Lifting time approx. sec.	Power kW	Weight approx. kg	Type
1000	35	250	1400 x 1000	400	7	1,1	500	BN-SG 100
2000	35	300	1400 x 1000	400	11	1,1	540	BN-SG 2000
-	45	-	-	-	-	-	-	On request

| Box lifting table
NT

| Adjustable stand
KS



Small helpers,
big effects

These small helpers are a must for any facility. The NT box tilting table and the KS adjustable stand are ideal for providing working materials at ergonomically favourable heights. The large tabletop of the tilting table provides space for two material boxes.

Standard fittings

- | Picking height adjustable
- | Tilt angle 30° max.
- | Spindles for height and tilt adjustment
- | Rubber wheels, Ø 75 mm
- | Swivel castors fitted with brakes

Standard fittings

- | Picking height adjustable
- | Tilt angle 30° max.
- | Screws for height and tilt adjustment
- | Polyamide wheels
- | Wheels, Ø 50 mm

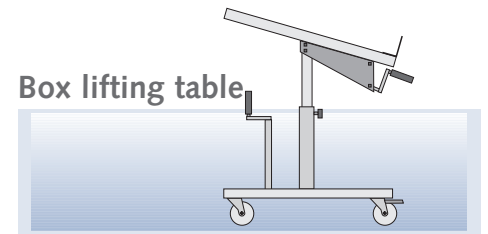

Box lifting table

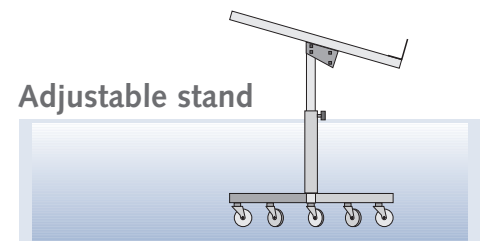

Adjustable stand

Box tilting table

NT

Load-bearing capacity kg	Tilt angle °	Tabletop mm	Wheels mm	Weight kg	Type
125	0-30	600 x 600	4 x Ø 75	40	NT

Adjustable stand

KS

Load-bearing capacity kg	Tilt angle °	Tabletop mm	Usable stroke mm	Wheels mm	Weight kg	Type
75	0-30	380 x 540	650 - 880	5 x Ø 50	8	KS
75	-	380 x 540	650 - 880	5 x Ø 50	8	KS
75	0-30	380 x 540	650 - 880	-	8	KS
75	-	380 x 540	650 - 880	-	8	KS

Lift table tools

WZW



The WZW lift table for tools is a robust truck for supplying tools. With its large-diameter wheels it is especially suitable for high-load capacity. Its small dimensions make it easy to use even when space is at a premium. It is fitted with a hydraulic pump for individual adjustment to an ergonomically favourable working height.

Standard fittings

- I Adjustable in height
- I Polyamide wheels, Ø 200 mm
- I Castors fitted with brakes

Lift table for tools

WZW

Load-bearing capacity kg	Usable stroke mm	Lift per pedal stroke mm	Tabletop mm	Wheels mm	Weight kg	Type
500	660 - 960	30	600 x 600	Ø 200	75	WZW

Fassrolli

550

Load-bearing capacity kg	Usable stroke mm	Weight kg	Lift per pedal stroke mm	Type
300	0 - 550	70	12	Fassrolli 550

Fassrolli



The drum gripper is a robust device designed for lifting and transporting 200 l steel drums. The gripping mechanism also holds the drum securely during transport.

Standard fittings

- I Gripping mechanism
- I Wheel extension arms adjustable in width
- I Front wheels Ø 200 mm
- I Supplied with additional set of wheels with Ø 70 mm to allow the drum gripper to be driven under pallets.

Lift table tools

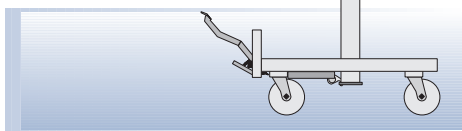

Fassrolli

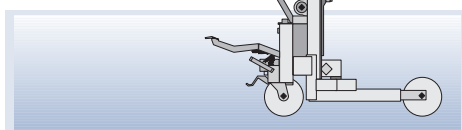



Fassboy FB 1400

Drum lifter features

The Fassboy FB 1400 drum lifter is a specially designed lift and tipping device for handling rolling hoop drums. The Fassboy drum lifter is wheeled to a standing drum which is then clamped into the drum basket. Using the hydraulic foot pump the drum is raised to the required height. This makes it easy to transport, lift, tip, mix and empty drums. The FB 1400 P drum lifter is a version with additional features. It is designed for handling steel and plastic drums of different diameters. Fassboy features:

Standard fittings

- | Hydraulic foot pump
- | Worm drive gearbox with handle to mix and empty drums
- | Cylinder fitted with hose failure protection
- | Large rubber wheels, Ø 200 mm
- | Castor wheel fitted with brake
- | Basket fitted with clamp for 200 l steel drums (FB 1400 only)
- | Prism with ratchet stop for steel and plastic drums Ø 400 - 600 mm (FB 1400 P only)



Fassboy FB 1400 P

Fassboy

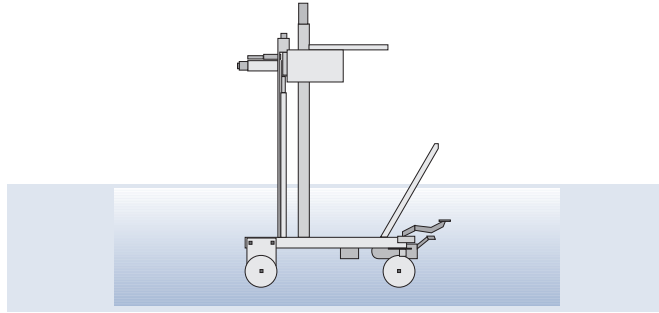

Fassboy 1400, 1400 P

Load-bearing capacity kg	Usable stroke mm	Lift per pedal stroke mm	Weight kg	Type
300	0 -1400	24	125	Fassboy 1400 *
300	0 -1400	24	125	Fassboy 1400 P **

* for 200 l steel drums

** for steel and plastic drums

Accessories

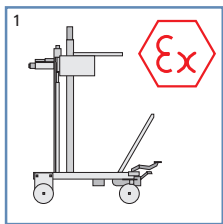

- 1 Drum lifters 1400 und 1400 P fitted with explosion protection (Zone 1 and 2 / T 3)
- 2 Drum lifter with extra high stroke of up to 2000 mm (4 wheels)

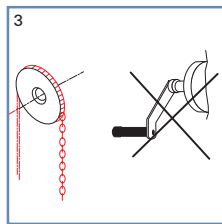
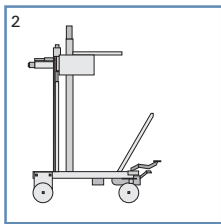

- 3 Chain instead of crank-handle drive
- 4 Voltage 12 V instead of foot pump
Supplied with battery but without battery charger

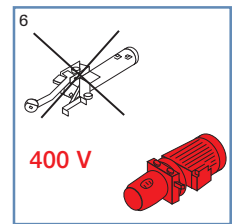
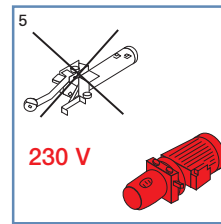
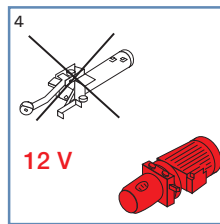

- 5 Voltage 230 V instead of foot pump
- 6 Voltage 400 V instead of foot pump

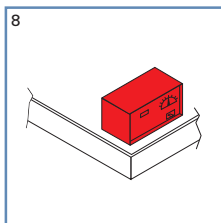
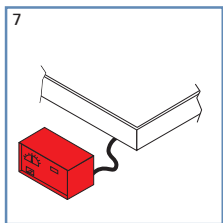

- 7 External battery charger (automatic)
Charging current 10 amps. max.
- 8 Integrated battery charger (automatic)
Charging current 7 amps. max.

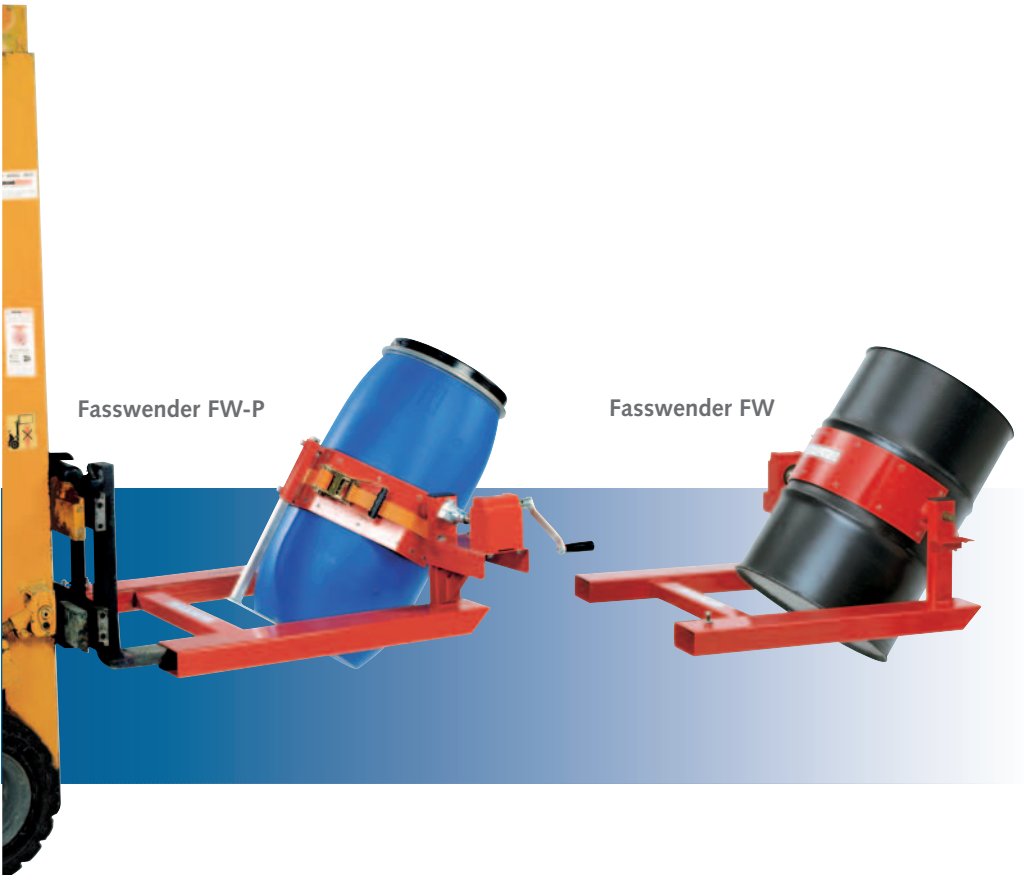

Get to the drums

The FW and FW P drum turners are designed as add-ons for fork lift trucks. The drum basket and the gearbox are identical with those of the drum lifter. The drum turner can lift, transport and tip drums. The handle is used for mixing and tipping operations.

Standard fittings

- I Slip clutch (protection against damage)
- I Worm drive gearbox with crank handle for mixing and emptying operations
- I Basket fitted with clamp for 200 l steel drums (FW)
- I Prism with ratchet stop for steel and plastic drums Ø 400 - 600 mm (FW-P)

Fasswender FW, FW-P

Load-bearing capacity kg	Weight kg	Type
300	80	Fasswender FW *
300	80	Fasswender FW-P **

* for 200 l steel drums
 ** for steel and plastic drums

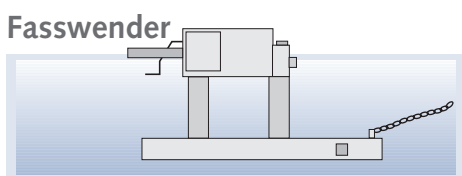

90° tilter

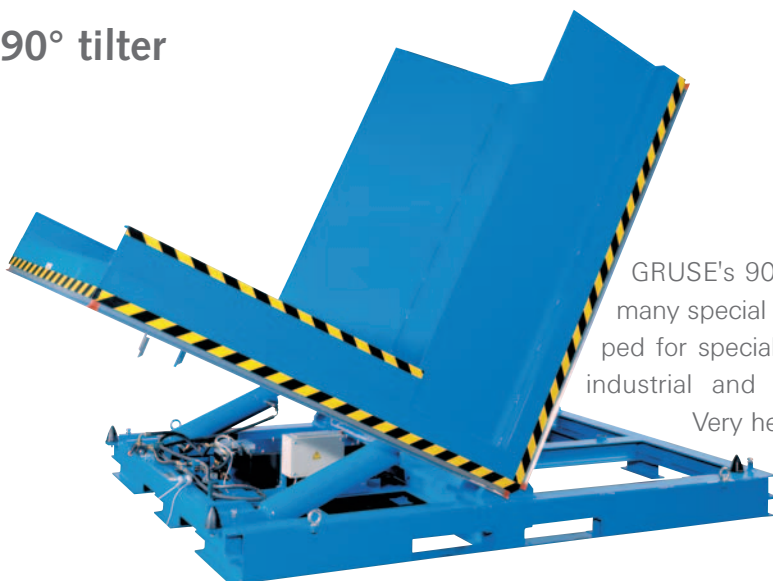

GRUSE's 90° tilter is one of many special designs developed for special applications in industrial and trade settings. Very heavy items need to be rota-

ted and loaded. The 90° tilter enables safe rotation of items with weights of up to three tons. A 90° tilter like this improves safety at work and increases output. 90° tilters can be fitted with many special design options.

Dustbin tipper MT 240



Dustbin tipper MT 240

Ideal for handling waste

The dustbin tipper is a special device used to tip and empty standard 240 l dustbins. It can be retrofitted with add-on parts for plastic 60-80-120-140 l or 240 l aluminium bins.

Standard fittings

- | Foot pump
- | Approx. 39 pedal strokes to reach maximum angle
- | Stainless steel carrier slides
- | Maximum load-bearing capacity: 150 kg
- | Rubber castors and wheels Ø 200 mm
- | Castors fitted with brakes
- | Tipping angle 130° max.
- | Tipping height 1300 mm
- | Outer dimensions: L x W x H 1430 x 1100 x 1635

Dustbin tipper MT 240

Load-bearing capacity	Tipping angle °	Drive	For bins with	Weight of approx. kg	Type
150 kg	130	foot pump	240 l	120	MT 240

Accessories

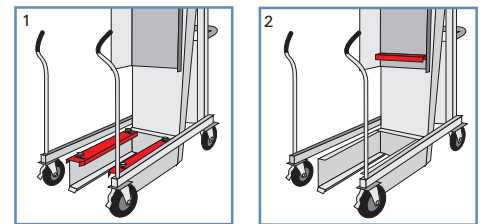

- 1 Add-on component for 60/80/120/140 l dustbins
- 2 Add-on component for 240 l aluminium bins
Clearance for assembly on carrier slide

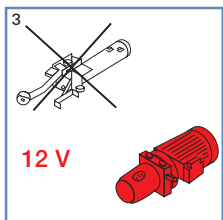

- 3 12 V drive instead of foot pump, shipped with battery but without battery charger
- 4 230 V drive instead of foot pump

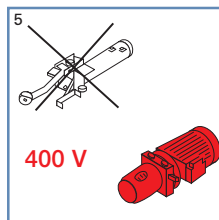
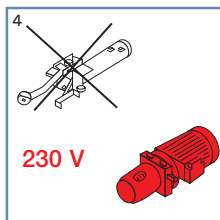

- 5 400 V drive instead of foot pump
- 6 External battery charger (automatic)
Charging current 10 amps. max.

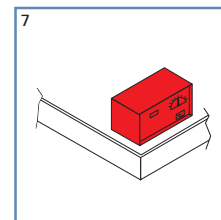
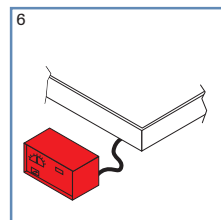

- 7 Integrated battery charger (automatic) charging current 7 amps. max.

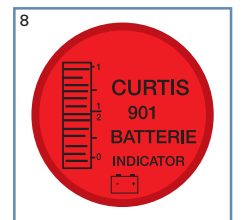

- 8 Battery capacity indicator with unit switch for 12 V units by Curtis

Handy



Our Handy provides mobility

Our Handy lifting column is designed to meet ergonomic requirements for the lifting and transporting of loads up to 250 kg. The masts are available in three different lengths.

Standard fittings

- I Drive: foot pump or electro-hydraulic pump 12 V
 - I Mast made of aluminium
 - I Chassis and load-lifting attachments made of steel
 - I Castors and wheels
Ø 125 bzw. 75 mm
 - I Castors fitted with brakes
- Special attachments available on request.

Handy

Handy

Load-bearing capacity kg	Usable stroke mm	Tabletop mm	Drive	Stroke per pedal operation/ lifting time	Dimensions mm	Weight kg	Type
250	135 - 935	750 x 625	foot pump	20 mm	1260 x 625 x 1405	90	Handy 800
250	135 - 935	750 x 625	12 V/55 Ah	7 sec.	1260 x 625 x 1405	115	Handy 800 E
250	135 - 1385	750 x 625	foot pump	20 mm	1260 x 625 x 1855	100	Handy 1250
250	135 - 1385	750 x 625	12 V/55 Ah	10 sec.	1260 x 625 x 1855	155	Handy 1250 E
250	135 - 1935	750 x 625	foot pump	20 mm	1260 x 625 x 2405	115	Handy 1800
250	135 - 1935	750 x 625	12 V/55 Ah	14 sec.	1260 x 625 x 2405	135	Handy 1800 E

Accessories

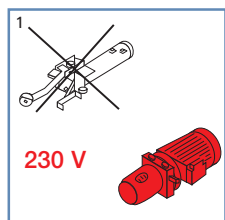

- 1 Drive: 230 V instead of foot pump
- 2 400 V drive instead of foot pump

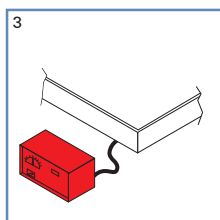
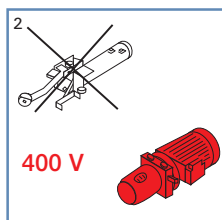

- 3 External battery charger (automatic) charging current 10 amps. max.
- 4 Integrated battery charger (automatic) charging power 7 amps. max.

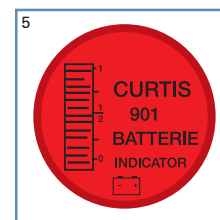
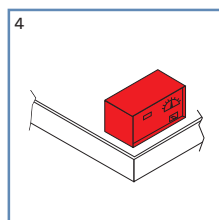

- 5 Battery capacity indicator with unit switch for 12 V units, by Curtis
- 6 Battery capacity indicator without unit switch for 12 V devices

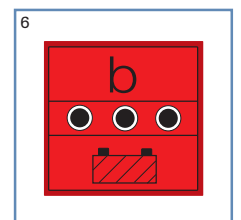



Lifting without backstrain

These assembly tables provide an ideal solution for departments involved in assembly, maintenance or packaging operations. They are indispensable assistants for work at ergonomic heights. GRUSE supplies lift tables with load-bearing capacities of 500, 1000 und 2000 kg. High flexibility allows these lift tables to be moved on their wheels to any desired location. GRUSE is absolutely committed to safety. All lift tables are manufactured to comply with the European DIN EN. Customers have a choice between assembly tables with or without fixed bearing.

Assembly Lift Tables

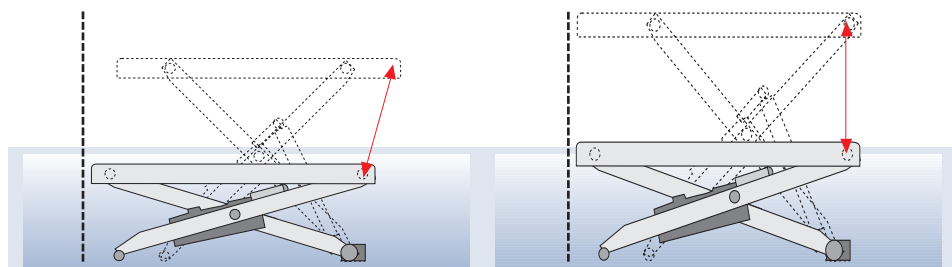

Without fixed bearing

Tabletop moves laterally – optimum tabletop support in the centre.

With fixed bearing

Tabletop is lifted vertically, e.g. required for pit installation

Standard fittings

- | Operating voltage 400 V
- | Control voltage 230 V
- | Inspection strut
- | Dead man's control unit with manual push button control with emergency stop on 3 m cable
- | Tabletop made of smooth sheet metal
- | Hose failure protection: cylinders fitted with electric check valves
- | Safety rail (exception: M 500 B/FP)

Assembly Lift Tables M 2000



Assembly Lift Tables M 500 B/FP (with foot pump)

All other assembly lift tables M 500 (with electrical pump)



Product overview

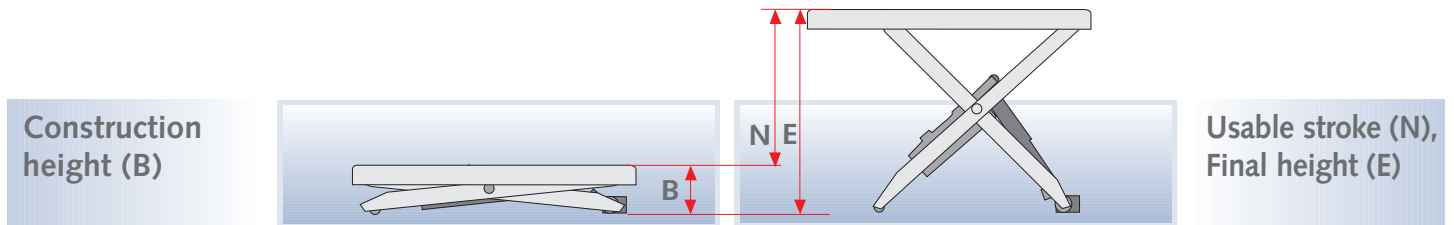

Assembly Lift Tables

M

Load-bearing capacity kg	Construction height (B) mm	Usable stroke (N) mm	Final height (E) mm	Tabletop mm	Sub-frame mm	Lifting time approx. sec.	Power kW	Weight ca. kg	Type
500	270	730	1000	1250 x 1000	without	foot pump	-	110	M 500 B/FP
500	200	800	1000	1250 x 800	without	10	0,8	115	M 500
500	200	800	1000	1250 x 1000	without	10	0,8	120	M 500 B
500	240	1000	1240	1600 x 800	without	12	0,8	150	M 500 L
500	240	1000	1240	1600 x 1000	without	12	0,8	130	M 500 LB
1000	210	690	900	1250 x 800	without	10	1,1	135	M 1000
1000	210	690	900	1250 x 1000	without	10	1,1	160	M 1000 B
1000	255	1000	1255	1600 x 800	without	13	1,1	185	M 1000 L
1000	255	1000	1255	1600 x 1000	without	13	1,1	190	M 1000 LB
2000	215	630	845	1250 x 800	without	20	1,1	210	M 2000
2000	215	630	845	1250 x 1000	without	20	1,1	245	M 2000 B

Other dimensions and load-bearing capacities available on request.

Accessories

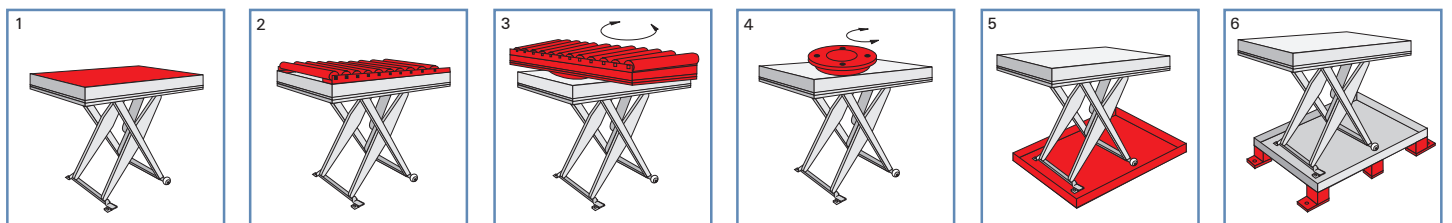

- 20 mm multiplex wooden surface
- Roller conveyor, rigid, max. 1000 kg (construction height + 115 mm)

- Roller conveyor, swivelling, max. 1000 kg (construction height + 160 mm)
- No-stop pivot \varnothing 750 mm (construction height + 48 mm)

- Sub-frame as oil collection tray (construction height + 5 mm)
- Base with legs, subframe clearance H = 100 - 200 mm

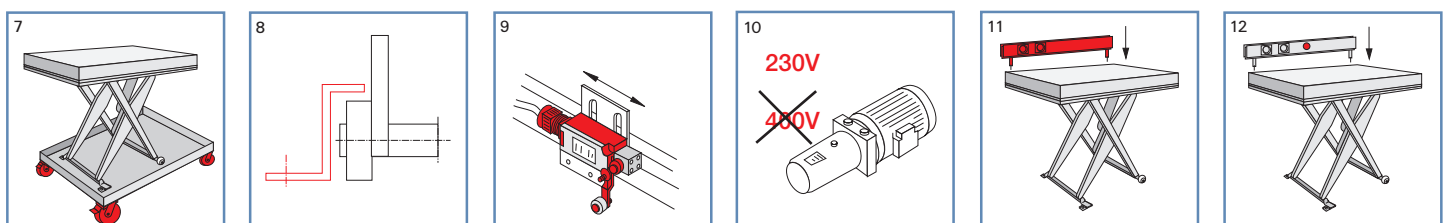

- Plastic wheels for subframe, \varnothing 100 mm clearance, only for M 500 and M 500 B
- Anti-lift safeguard for scissor rollers

- Adjustable limit switch
- 230 V hydraulic pump instead of 400 V hydraulic pump

- Plug-in energy strip, sockets 2 x 230 V
- Add-on for compressed air for energy strip, one $\frac{1}{2}$ -inch coupling unit

Low-profile lift table

Ergo-E



Standard fittings

- | Operating voltage 400V
- | Construction height 80mm
- | Usable stroke 750mm
- | Load-bearing capacity from 600 to 1500kg
- | Loading with fork lift truck
- | Suitable for Euro and industrial pallets with skeleton containers
- | No inconvenient sub-frame
- | Easy to move
- | Platform made of 6 mm smooth sheet metal
- | Dead man's control unit at hydraulic unit
- | High quality hydraulic components
- | Compact hydraulic unit (10 % power-on time)
- | Contact strip for foot protection
- | Safety in line with EN 1520
- | Maintenance-free roller bearings

Low-profile lift table Ergo-E



Construction height (B)

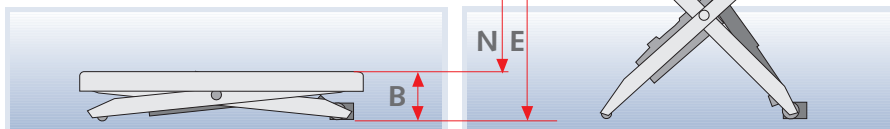

Usable stroke (N), Final height (E)

Low-profile lift table

Ergo-E

Load-bearing capacity kg	Construction height (B) mm	Usable stroke (N) mm	Final height (E) mm	Tabletop mm	Sub-frame mm	Lifting time approx. sec.	Power kW	Weight ca. kg	Type
600	80	670	750	1350 x 1150	ohne	16	0,35	200	Ergo-E 600
900	80	670	750	1350 x 1150	ohne	17	0,35	215	Ergo-E 900
1200	80	670	750	1350 x 1150	ohne	18	0,35	230	Ergo-E 1200
1500	80	670	750	1350 x 1150	ohne	20	0,35	250	Ergo-E 1500

Other dimensions and load-bearing capacities available on request.

Low-profile lift table Ergo-E



Ergonomics at work

The extremely low construction height of a mere 80 mm and the E-shaped platform can be loaded and unloaded using any commercial fork-lift truck.



Loads of up to 1500 kg are safe and secure on the lift table, which can be individually adjusted to the ideal ergonomic height.



The E-shaped platform supports all three pallet dividers, thus enhancing safety at work.



The hydraulic connection outlet at the lift table platform provides for rapid action coupling.

Low-profile lift table Ergo-G



Low-profile lift table Ergo-G



Standard fittings

- | Operating voltage 400V
- | Construction height 80mm
- | Usable stroke 750mm
- | Load bearing capacities from 600 to 1500kg
- | No pit installation required
- | Loading with fork lift trucks
- | Drive-on plate at the platform or for on-floor fastening
- | No inconvenient sub-frame
- | Platform made of 6mm smooth sheet metal
- | Dead man's control unit at hydraulic unit
- | High-quality hydraulic components
- | Compact hydraulic unit with 10% switch-on time
- | Contact strip for foot protection
- | Safety in line with EN 1520
- | Maintenance-free roller bearings

Construction height (B)

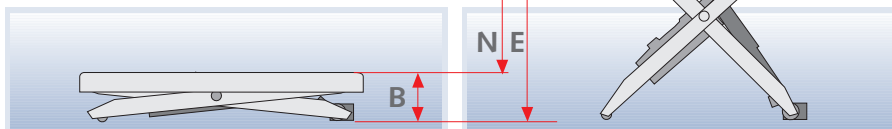

Usable stroke (N),
Final height (E)

Low-profile lift table Ergo-G

Load-bearing capacity kg	Construction height (B) mm	Usable stroke (N) mm	Final height (E) mm	Tabletop mm	Sub-frame mm	Lifting time approx. sec.	Power kW	Weight ca. kg	Type
600	80	670	750	1400 x 900	ohne	16	0,35	200	Ergo-G 600
900	80	670	750	1400 x 900	ohne	17	0,35	215	Ergo-G 900
1200	80	670	750	1400 x 900	ohne	18	0,35	230	Ergo-G 1200
1500	80	670	750	1400 x 900	ohne	20	0,35	250	Ergo-G 1500

Other dimensions and load-bearing capacities available on request.

Low-profile lift table **Ergo-G**



The ergonomic solution for all applications

Fork-lift or electric hoisting trucks can drive all kinds of load-carrying units onto the lift table using the drive-on plate.



The length of the 400 mm drive-on plate is designed to match the construction height of the lift table and the usable stroke of a fork-lift truck.



The drive-on plate can be supplied as a foldable device to be mounted on the platform or as a version for floor fastening.

| Column lift SH

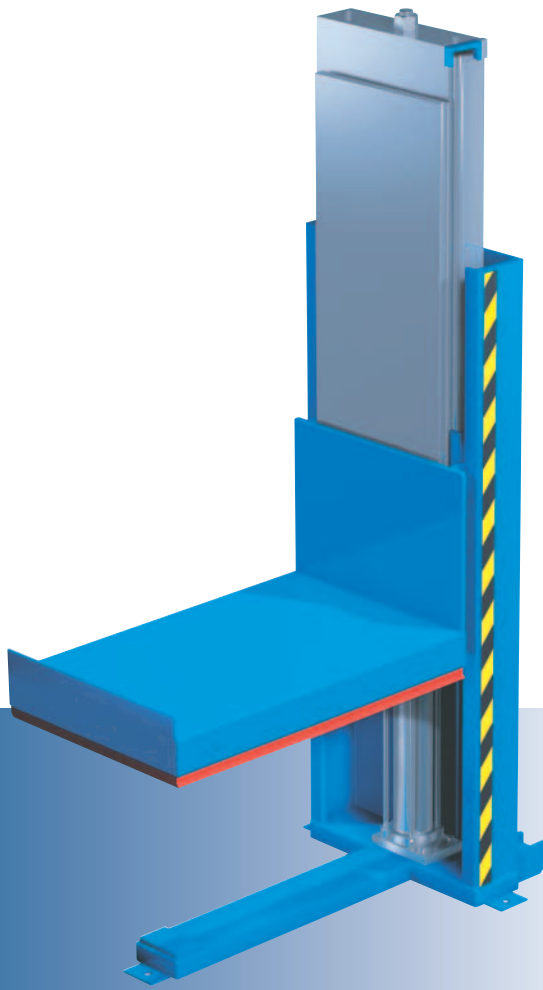

Column lift SH 1-50-10

Standard fittings

- | Operating voltage 400V
- | Control voltage 230V
- | Dead man's control unit with manual push-button control, key switch and emergency stop
- | Compact hydraulic unit with 10% switch-on time
- | Tabletop made of smooth sheet metal
- | Differential cylinder
- | Wheels, fixed-bearing, scissors and cylinder bolts easy to exchange
- | Safety rail
- | Maintenance-free roller bearings

Column lift SH

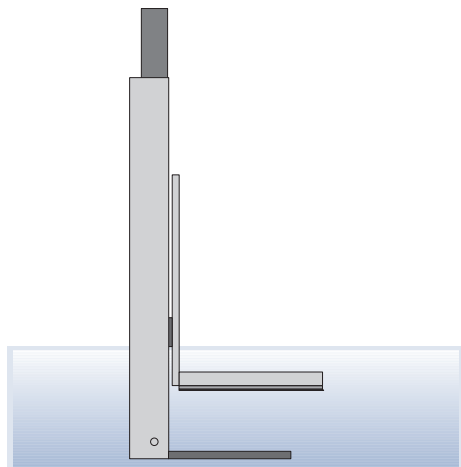

Hitting the heights

The column lift is used in facilities where major height differences (up to 5m) have to be negotiated. The platform of the column lift is easy to load with a fork-lift truck on account of its low construction height (min. 120 mm). In contrast to the scissors lift table, usable stroke, tabletop length and construction height are independent of each other.

The column lift can be operated from three sides. The fourth side is not accessible on account of the column construction. Here the column is fastened to the wall, thus ensuring maximum stability.

GRUSE's column lifts provide the ultimate in safety. Depending on the required lifting height they are fitted with a direct hydraulic cylinder drive or with double precision roll chains featuring a six-fold chain safety mechanism.

The platform is made of a torsion-resistant frame with a tear plate or smooth sheet metal surface. The rollers move in two highly stable heavy-duty fork-lifter profiles. The roller guides ensure smooth rolling, independently of the position of the load.

Column lift SH

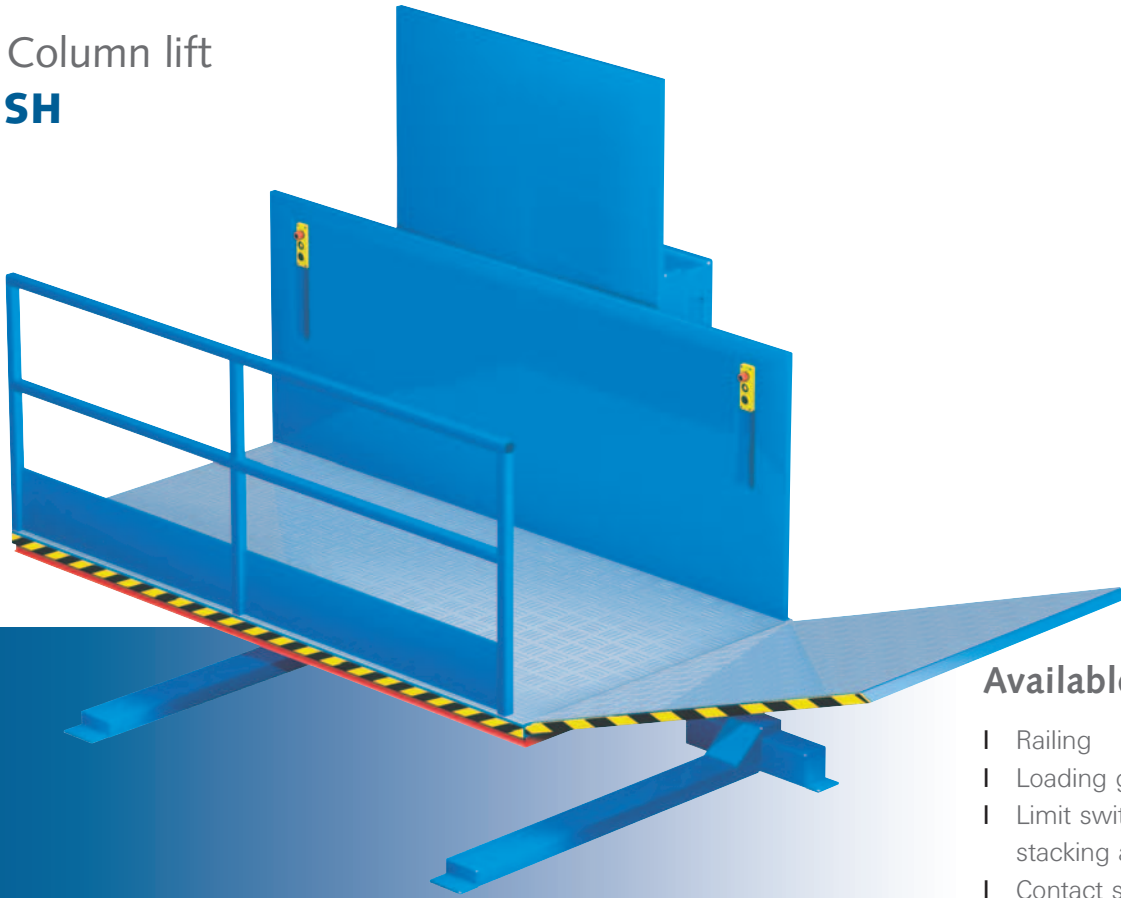

Available on request

- | Railing
- | Loading gate
- | Limit switch for automatic pulsing of stacking and destacking operations
- | Contact strip for foot protection

Customised column lift SH 1-50-10

Column lift SH

Other dimensions and load-bearing capacities available on request.

Load-bearing capacity kg	Usable stroke max. mm	Platform length mm	Platform width mm	Min. construction height platform mm	Lifting speed mm	Type
300	5000	1000-3000	1000	100	50-150	SH 0,3-50-10
300	5000	1000-3000	1500	100	50-150	SH 0,3-50-15
300	5000	1000-3000	2000	100	50-150	SH 0,3-50-20
300	5000	1000-3000	2500	100	50-150	SH 0,3-50-25
1000	5000	1000-3000	1000	105	50-150	SH 1-50-10
1000	5000	1000-3000	1500	105	50-150	SH 1-50-15
1000	5000	1000-3000	2000	125	50-150	SH 1-50-20
1000	5000	1000-3000	2500	125	50-150	SH 1-50-25
1500	5000	1000-3000	1000	105	50-150	SH 15-50-10
1500	5000	1000-3000	1500	105	50-150	SH 15-50-15
1500	5000	1000-3000	2000	125	50-150	SH 15-50-20
1500	5000	1000-3000	2500	125	50-150	SH 15-50-25
2000	5000	1000-3000	1000	100	50-150	SH 20-50-10
2000	5000	1000-3000	1500	125	50-150	SH 20-50-15
2000	5000	1000-3000	2000	145	50-150	SH 20-50-20
2000	5000	1000-3000	2500	145	50-150	SH 20-50-25
2500	5000	1000-3000	1000	150	50-150	SH 25-50-10
2500	5000	1000-3000	1500	150	50-150	SH 25-50-15
2500	5000	1000-3000	2000	160	50-150	SH 25-50-20
2500	5000	1000-3000	2500	160	50-150	SH 25-50-25
3000	5000	1000-3000	1000	160	50-150	SH 30-50-10
3000	5000	1000-3000	1500	160	50-150	SH 30-50-15
3000	5000	1000-3000	2000	180	50-150	SH 30-50-20
3000	5000	1000-3000	2500	200	50-150	SH 30-50-25

| Pallet transfer station **PAS**

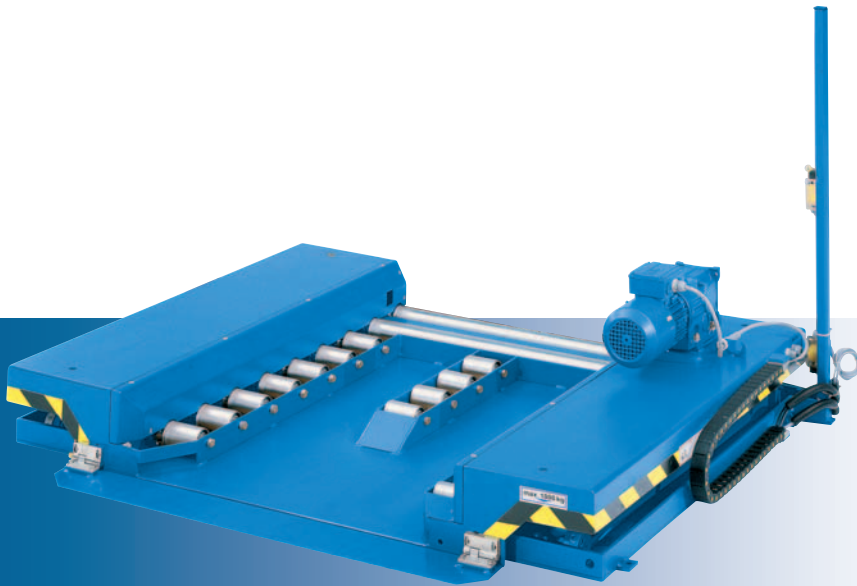

Take-up and move on to conveying unit

This electro-hydraulic pallet transfer station is ideal for industrial plants with automated conveyor systems. The GRUSE pallet transfer station is not only the most cost-effective alternative to fork-lifters but also provides for easier handling and time-saving operations. The extremely flat construction height and the integrated conveying unit that can be loaded directly with a lift truck make fork-lifters redundant.

Another cost-reducing factor is that expensive pit installations are not required on account of the ground-level design.



| Pallet transfer station **PAS**



Standard fittings

- | Load-bearing capacity up to 1500kg
- | Usable stroke up to 840 mm or designed to your specifications
- | Platform sizes 1200 x 800 mm and 1200 x 1000 mm
- | Pallet lifting station with driven roller conveyor
- | Pallet transfer station with its own drive, loading with manually operated lift trucks, non-driven central rollers
- | Photocell control system
- | Compact hydraulic unit with 10% switch-on time
- | Wheels, fixed-bearing, scissors and cylinder bolts easy to exchange
- | Safety contact strip (side protection)
- | Maintenance-free roller bearings

Pallet transfer station PAS

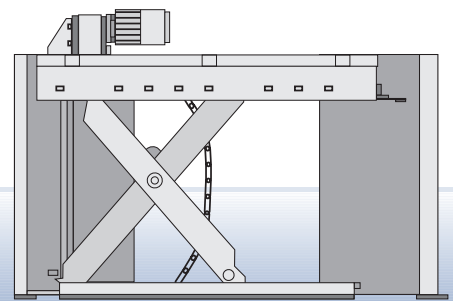



| Gruse Maschinenbau GmbH & Co. KG
Dibbetweg 32
D-31855 Aerzen
(Groß Berkel)

| Tel. Switchboard: +49 (0) 51 54 - 95 10-0
Fax Sales: +49 (0) 51 54 - 20 30
Fax Purchasing: +49 (0) 51 54 - 95 10-65
Internet: www.gruse.de
E-Mail: info@gruse.de