

BMF

WWW.BMF.EE

We like hard work!



SPECIALIZED IN THE PRODUCTION
OF **FOREST TRAILERS AND CRANES**

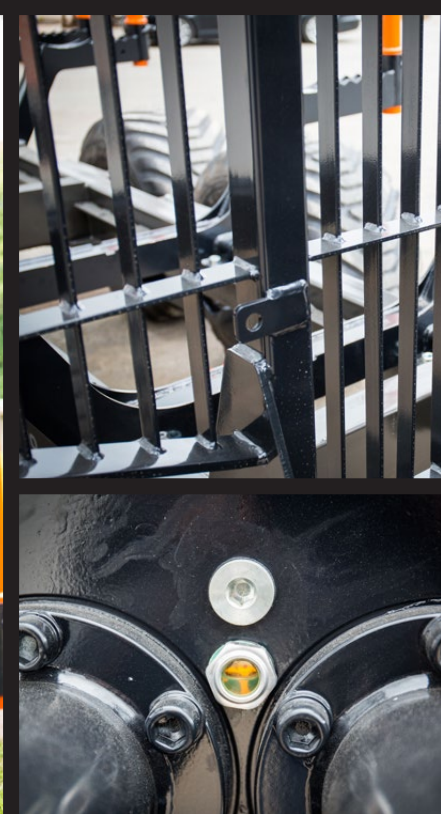
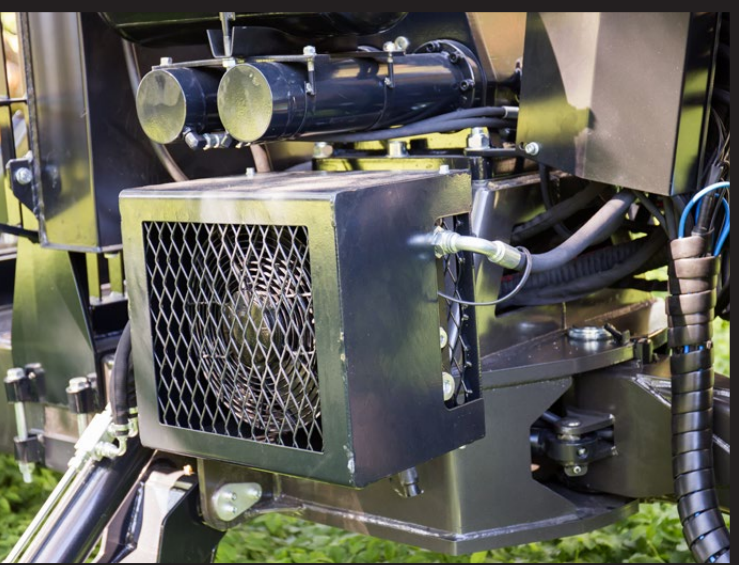

BMF (OÜ Lisako) began operating back in 2001. From 2006 the machine building company specialized in the manufacturing of forest trailers and cranes. From 2013 we started to sell our products under the BMF trademark.

Estonia is a country where half of the territory is covered with forest. Long term traditions in local forestry create a good environment for designing and producing innovative and highly valued forest trailers and cranes.

Sets

We have combined from our product range in 7 different sets, of which most customers, from the hobby farmer up to forest professionals, can find an appropriate model. Loading capacity starts from 6 t and ends at 17 t. Crane maximum reach starts from 4.3 m and ends at 9.05 m.

BMF 6T ₂ / BMF 430	4
BMF 7T ₁ / BMF 540	5
BMF 8T ₁ / BMF 650	6
BMF 10T ₂ / BMF 720	7
BMF 12T ₂ / BMF 750	8
BMF 14T ₂ / BMF 850	9
BMF 17T ₂ / BMF 905	10

Tailor-made

With a choice among 13 different trailers and 7 different cranes every client can compile a personal set that matches their preferences.

Measures & Data	11
Trailer / Crane Compatibility	12

Accessories

A wide range of accessories helps the client to create a very personal tool.

Accessories	14
-------------------	----



BMF 6T₂

Platform trailer with loading capacity up to 6 tonnes equipped with 4.3 meter crane.

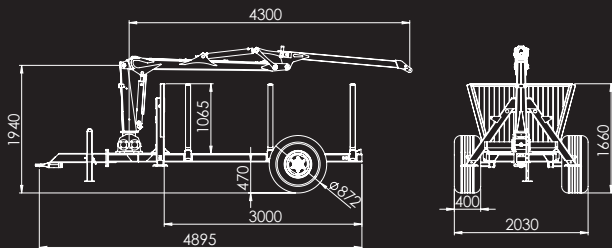

Trailer BMF 6T₂

Loading capacity, kg	6 000
Total length, mm	4 895
Length of loading area, mm	3 000
Total width with standard wheels, mm	2 030
Wheels	11.5/80-15.3 400/60-15.5
Chassis, mm	60X120X6
Axels	70x70-6
Loading area, m ²	1.30
Drawbar cylinders, pcs	-
Drawbar angle to sides, ± °	-
Clearance, mm	470
Trailer-mounted support leg type	A



BMF 7T₁

Single-beam trailer with loading capacity up to 7 tonnes equipped with 5.4 meter crane.

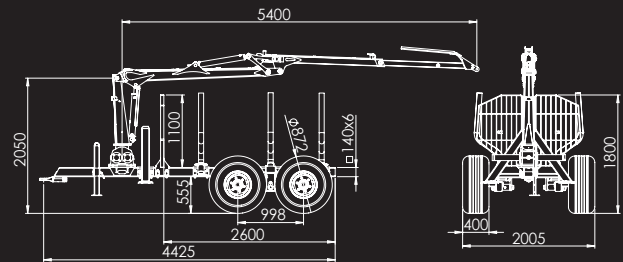

Trailer BMF 7T₁

Loading capacity, kg	7 000
Total length, mm	4 425
Length of loading area, mm	2 800
Total width with standard wheels, mm	2 005
Wheels	11.5/80-15.3 400/60-15.5
Chassis, mm	140x140x6
Axels	60x60-6
Loading area, m ²	1.45
Drawbar cylinders, pcs	-
Drawbar angle to sides, ± °	-
Clearance, mm	555
Trailer-mounted support leg type	A

BMF 8T₁

Single-beam trailer with loading capacity up to 8 tonnes equipped with 6.5 meter crane.

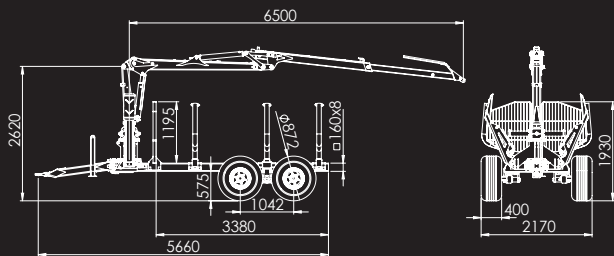

Trailer BMF 8T₁

Loading capacity, kg	8 000
Total length, mm	5 660
Length of loading area, mm	3 380
Total width with standard wheels, mm	2 170
Wheels	400/60-15.5 500/50-17 520/50-17
Chassis, mm	160x160x8
Axels	60x60-6
Loading area, m ²	1.95
Drawbar cylinders, pcs	1
Drawbar angle to sides, ± °	40
Clearance, mm	575
Trailer-mounted support leg type	-





BMF 10T₂

Double-beam trailer with loading capacity up to 10 tonnes equipped with 7.2 meter crane.

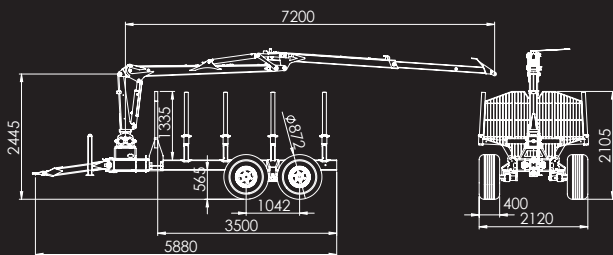

Trailer BMF 10T₂

Loading capacity, kg	10 000
Total length, mm	6 380
Length of loading area, mm	4 000
Total width with standard wheels, mm	2 120
Wheels	400/60-15.5 500/50-17 520/50-17
Chassis, mm	2x(200x100x6)
Axels	70x70-6
Loading area, m ²	2.20
Drawbar cylinders, pcs	2
Drawbar angle to sides, ± °	40
Clearance, mm	565
Trailer-mounted support leg type	A/FD

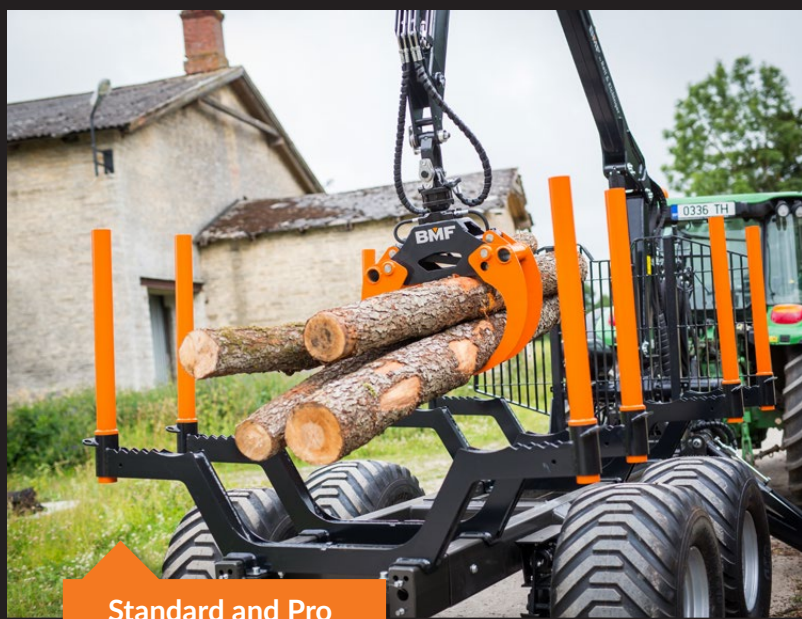

Standard and Pro versions available.





Standard and Pro versions available.

BMF 12T₂

Double-beam trailer with loading capacity up to 12 tonnes equipped with 7.5 meter crane.

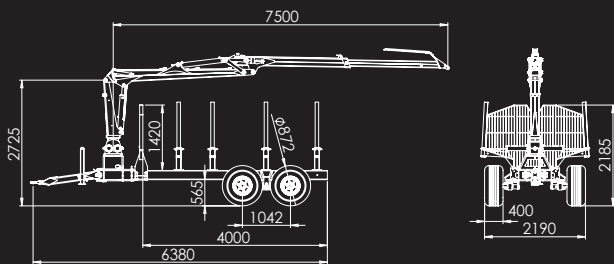

Trailer BMF 12T₂

Loading capacity, kg	12 000
Total length, mm	6 600
Length of loading area, mm	4 200
Total width with standard wheels, mm	2 185
Wheels	400/60-15.5 500/50-17 520/50-17
Chassis, mm	2x(200x100x6)
Axles	70x70-6
Loading area, m ²	2.45
Drawbar cylinders, pcs	2
Drawbar angle to sides, ± °	40
Clearance, mm	565
Trailer-mounted support leg type	A/FD



BMF 14T₂

Double-beam trailer with loading capacity up to 14 tonnes equipped with 8.5 meter crane.

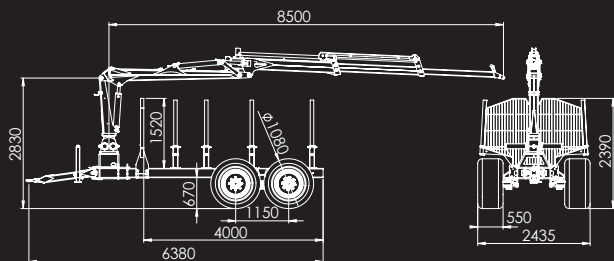

Pro version only.



Trailer BMF 14T₂

Loading capacity, kg	14 000
Total length, mm	6 600
Length of loading area, mm	4 200
Total width with standard wheels, mm	2 435
Wheels	550/45-22.5
Chassis, mm	2x(200X100X6)
Axels	80X80-8
Loading area, m ²	2.45-2.8
Drawbar cylinders, pcs	2
Drawbar angle to sides, ± °	40
Clearance, mm	670
Trailer-mounted support leg type	A/FD

BMF 17T₂

Double-beam trailer with loading capacity up to 17 tonnes equipped with 9.05 meter crane.

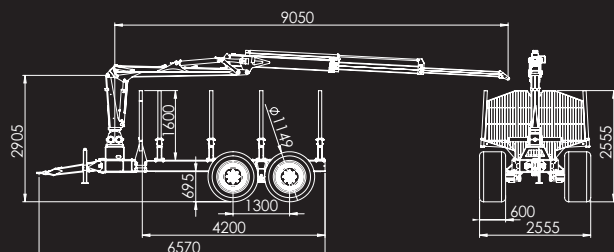

Trailer BMF 17T₂

Loading capacity, kg	17 000
Total length, mm	6 920
Length of loading area, mm	4 200
Total width with standard wheels, mm	2 520
Wheels	550/45-22.5 600/50/22.5
Chassis, mm	2x(200x100x8) raex400(8mm)
Axels	90X90-8
Loading area, m ²	2.9-3.4
Drawbar cylinders, pcs	2
Drawbar angle to sides, ± °	40
Clearance, mm	695
Trailer-mounted support leg type	FD



Trailers

	BMF 6T2	BMF 7T1	BMF 8T1	BMF 8T2	BMF 9T1	BMF 9T2
Loading capacity, kg	6 000	7 000	8 000	8 000	9 000	9 000
Total length, mm	4 895	4 425	5 660	5 955	6 160	6 180
Length of loading area, mm	3 000	2 800	3 380	3 575	3 850	3 800
Total width with standard wheels, mm	2 030	2 005	2 170	2 120	2 170	2 120
Wheels	11.5/80-15.3 400/60-15.5	11.5/80-15.3 400/60-15.5	400/60-15.5 500/50-17 520/50-17	400/60-15.5 500/50-17 520/50-17	400/60-15.5 500/50-17 520/50-17	400/60-15.5 500/50-17 520/50-17
Chassis, mm	60X120X6	140x140x6	160x160x8	2x(200x100x6)	160x160x8	2x(200x100x6)
Axels	70x70-6	60x60-6	60x60-6	60x60-6	70x70-6	70x70-6
Loading area, m ²	1.30	1.45	1.95	2.20	1.95	2.20
Drawbar cylinders, pcs	-	-	1	1	2	2
Drawbar angle to sides, ± °	-	-	40	40	40	40
Clearance, mm	470	555	575	550	575	565
Trailer-mounted support leg type	A	A	-	-	-	-

	BMF 10T2 (Pro)	BMF 11T1	BMF 12T2 (Pro)	BMF 14T2 Pro	BMF 17T2 Pro
Loading capacity, kg	10 000	11 000	12 000	14 000	17 000
Total length, mm	6 380	6 185	6 600	6 600	6 920
Length of loading area, mm	4 000	3 870	4 200	4 200	4 200
Total width with standard wheels, mm	2 120	2 275	2 185	2 435	2 520
Wheels	400/60-15.5 500/50-17 520/50-17	400/60-15.5 500/50-17 520/50-17	400/60-15.5 500/50-17 520/50-17	550/45-22.5	550/45-22.5 600/50/22.5
Chassis, mm	2x(200x100x6)	200x200x8	2x(200x100x6)	2x(200X100X6)	2x(200x100x8) raex400(8mm)
Axels	70x70-6	70x70-6	70x70-6	80X80-8	90X90-8
Loading area, m ²	2.20	2.30	2.45	2.45-2.8	2.9-3.4
Drawbar cylinders, pcs	2	2	2	2	2
Drawbar angle to sides, ± °	40	40	40	40	40
Clearance, mm	565	580	565	670	695
Trailer-mounted support leg type	A/FD	-	A/FD	A/FD	FD

Cranes

	BMF 430	BMF 540	BMF 650	BMF720	BMF 750	BMF 850	BMF 905
Maximum reach, m	4.3	5.4	6.5	7.2	7.5	8.5	9.05
Lifting torque, kNm, gross	29	29	46	57	68	68	68
Lifting power at 4 m w/o grapple and rotator, kg	620 (3 m)	550	835	1000	1420	1360	1350
Lifting power at full reach w/o grapple and rotator, kg	420	385	530	560	615	515	490
Grapple, m ²	0.15	0.15	0.2	0.2/0.24	0.24/0.27	0.24/0.27	0.24/0.27
Rotator, t	3	3	3 / 4	3 / 4	4	4	4
Slewing torque, kNm	4.9	4.9	10	14.5	17	17	20.5
Slewing cylinders, pcs	2	2	4	4	4	4	4
Boom rotation, °	360	360	360	370	370	370	370
Working Pressure, bar	190	190	190	190	190	190	190
Hydr pump capacity, l/min	30-60	30-60	30-60	30-60	40-80	40-80	40-80
Support leg type	A	A	A/FD	A/FD	FD	FD	FD
Wide angle	•	•	•	•	•	•	•
Telescope	-	•	•	•	•	x2	x2

COMPATIBILITY

Trailer / Crane Compatibility

	BMF 430	BMF 540	BMF 650	BMF 720	BMF 750	BMF 850	BMF 905
BMF 6T ₂	●	●					
BMF 7T ₁	●	●					
BMF 8T ₁			●	●			
BMF 8T ₂			●	●			
BMF 9T ₁			●	●			
BMF 9T ₂			●	●			
BMF 10T ₂			●	●			
BMF 10T ₂ Pro			●	●			
BMF 11T ₁			●	●	●	●	●
BMF 12T ₂			●	●	●	●	●
BMF 12T ₂ Pro			●	●	●	●	●
BMF14T ₂ Pro					●	●	●
BMF 17T ₂ Pro					●	●	●



BMF production facility at Lääne-Viru county, in Arkna village houses 6000 m² of manufacturing space.



There are more than 100 different species of pine all over the world, but Scots pine (*Pinus Sylvestris*) is native to Eurasia. In Estonia Scots pine is the only pine species and as well the most common tree in our forests. The conditions are favourable and so it is no wonder that the tallest Scots pine with the height reaching 46,6 meters can be found here.

Scots pine is an important tree in forestry being used for pulp and sawn timber products. The time when branchless tall pines were the material for sailing ship masts is over but pine retains its value in making furniture and being used as a building material.

ACCESSORIES

Grapples

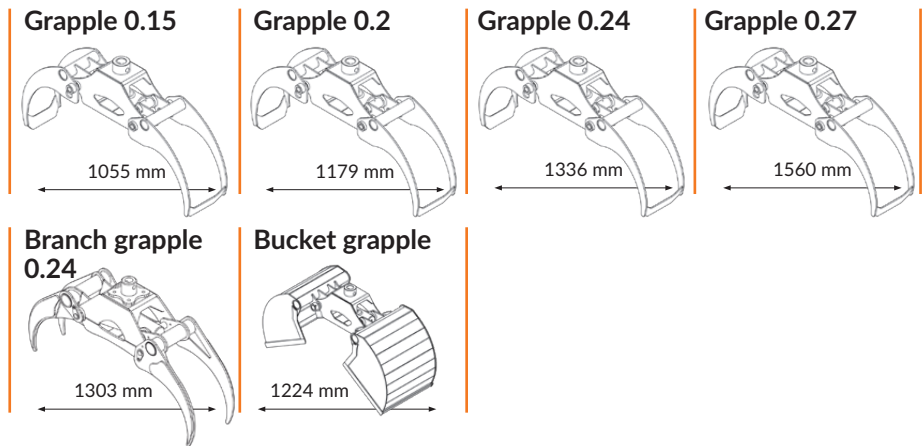

Valves

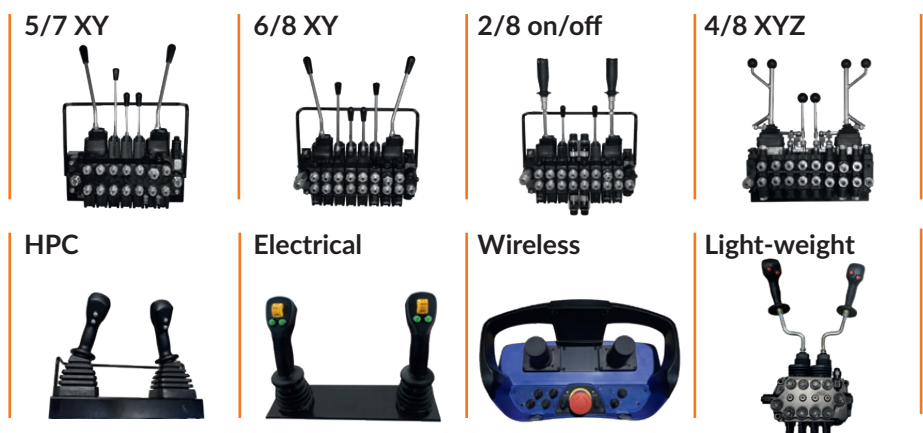

	BMF 430	BMF 540	BMF 650	BMF 720	BMF 750	BMF 850	BMF 905
Valve block 5/7XY (50l)	•						
Valve block 6/8XY (55l)		•	•	•			
Valve block on/off 60l		•	•	•			
Valve block 4/8 xyz (60L)		•	•	•			
Light weight Hydrocontrol		•	•	•			
Valve block 4/8 xyz (80L)					•	•	•
Valve block on/off 80l					•	•	•
Valve block HPC			•	•			
Hydrocontrol Electrical EX38				•	•	•	•
Wireless valve with Scanreco				•	•	•	•
Walvoil DPX 100/8					•	•	•
Hydrocontrol DVS14 prehydr			•	•	•		
Hydrocontrol DVS14 full electric			•	•	•		

Hydraulic pumps



Brakes

Pneumatic



Hydraulic



Overrun

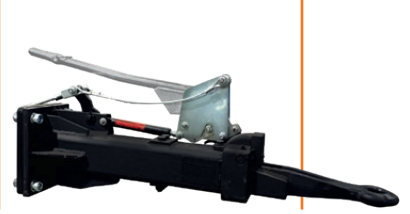

Extension

Double beam



Single beam



Lights

Kilpi special forest lights



Folded lights



Other

4 WD



Black Bruin 2 WD / 4 WD



Load beam for double beam trailers



Platform



Winch



3 YEAR
Warranty



Three year warranty
for frame, crane
and turning house.

Bronze bearings (except 0.15)

Body and teeth made of Hardox

Main boom made of Strenx
performance steel

Trailer frame
S 420 upgrade

Poles 89 x 8 mm

All pins 42 CrMo4

Main boom cylinder
protection

Racks 42 CrMo4

Oil window in
turning house

Special forest wheels

Powder coated

Pro version
- extra strong, removable

Adjustable sliders

BMF

WWW.BMF.EE

OÜ Lisako

Arkna, Rakvere Parish 44419 Estonia

+372 51 65036

info@bmf.ee

www.bmf.ee