

Gryphon™ I GD44XX

**General Purpose Coded Handheld
Area Imager Bar Code Reader**



Quick Reference Guide

Datalogic Scanning, Inc.

959 Terry Street

Eugene, Oregon 97402

USA

Telephone: (541) 683-5700

Fax: (541) 345-7140

An Unpublished Work - All rights reserved. No part of the contents of this documentation or the procedures described therein may be reproduced or transmitted in any form or by any means without prior written permission of Datalogic Scanning, Inc. or its subsidiaries or affiliates ("Datalogic" or "Datalogic Scanning"). Owners of Datalogic products are hereby granted a non-exclusive, revocable license to reproduce and transmit this documentation for the purchaser's own internal business purposes. Purchaser shall not remove or alter any proprietary notices, including copyright notices, contained in this documentation and shall ensure that all notices appear on any reproductions of the documentation.

Should future revisions of this manual be published, you can acquire printed versions by contacting your Datalogic representative. Electronic versions may either be downloadable from the Datalogic website (www.scanning.datalogic.com) or provided on appropriate media. If you visit our website and would like to make comments or suggestions about this or other Datalogic publications, please let us know via the "Contact Datalogic" page.

Disclaimer

Datalogic has taken reasonable measures to provide information in this manual that is complete and accurate, however, Datalogic reserves the right to change any specification at any time without prior notice.

Datalogic and the Datalogic logo are registered trademarks of Datalogic S.p.A. in many countries, including the U.S.A. and the E.U. All other brand and product names may be trademarks of their respective owners.

Patents

This product may be covered by one or more of the following patents:

Design Patents: CN ZL200830142386.5; CN ZL200930006852.1; EP870787; USD599799; USD606076

Utility Patents: EP996284; EP999514; EP1128315; EP1172756; EP1396811; EP1413971; EP1828957; JP4435343; US5481098; US6478224; US6512218; US6513714; US6561427; US6758403; US6808114; US6877664; US6997385; US7053954; US7234641; US7387246; US7721966.

Additional patents pending.

Table of Contents

Software Product Policy	4
Customers Under Software Support	4
Description	5
Setting Up the Reader	6
Connect/Disconnect Cable to Reader	6
Using the Gryphon™ I GD44XX	7
Selecting the Interface Type	8
Interface Selection	8
Configuring the Interface	8
Keyboard Interface.....	11
Scancode Tables	13
Country Mode.....	13
Caps Lock State	18
Numlock.....	19
Programming	20
Using Programming Bar Codes	20
Configure Other Settings	20
Resetting Product Defaults	20
Reading Parameters	21
Aiming System	21
Good Read Green Spot Duration	21
Operating Modes	22
Scan Mode	22
Stand Mode Operation.....	24
Pick Mode	25
Multiple Label Reading	25
Technical Specifications	26
LED and Beeper Indications	29
Error Codes	32
Cleaning	33
Regulatory Information	34
Statement of Agency Compliance	34
FCC Class B Compliance Statement	34
Canadian Notice	35
Power Supply	35
Imager Labeling	36
Aiming System.....	36
WEEE Statement	41
Datalogic Scanning Limited Factory Warranty	42
Ergonomic Recommendations	44
Services and Support	45

NOTES

Datalogic Scanning, Inc.

GRYPHON™ PRODUCT SERIES

END USER LICENSE AGREEMENT

Notice to End User: The Datalogic Product you have acquired contains embedded Software, which is integral to the product's operation. This Software is being provided to you under license, subject to the terms and conditions of this Agreement. If you use the Datalogic Product, you will be deemed to have accepted the terms and conditions of this Agreement. If you do not intend to be bound to the terms of this Agreement, Datalogic is not willing to license the Software to you, you may not use the Datalogic Product or the Software, and you must contact the party from whom you acquired the Datalogic Product for instructions.

This End User Software License Agreement ("Agreement") is a legally binding agreement governing the licensing of the Software and Documentation by Datalogic Scanning, Inc. and its Affiliates ("Datalogic") to the entity or person who has purchased or otherwise acquired a Datalogic Product ("End User"). For purposes of this Agreement, any software that is associated with a separate end-user license agreement is licensed to you under the terms of that license agreement. Datalogic and End User hereby agree as follows:

1. Definitions

- 1.1 "Affiliate" means a business entity currently existing or later acquired that controls, is controlled by, or is under common control with Datalogic S.p.A.
- 1.2 "Documentation" means materials such as user's guides, program reference guides, quick reference guides, manuals, or similar materials associated with or related to the Datalogic Product, whether in printed, "online", or other form.
- 1.3 "Proprietary Information" means: (a) source code, object code, software, documentation, and any related internal design, system design, data base design, algorithms, technology, technical data or information, implementation techniques, and trade secrets related to the Software, (b) any other trade secrets marked appropriately or identified as proprietary or confidential, and (c) any information that End User, under the circumstances, should recognize as confidential. Proprietary Information does not include any information that the receiving party can establish was (1) in the public domain, (2) already in the receiving party's possession or rightfully known prior to receipt, (3) rightfully learned from a third party not in violation of any other's proprietary rights, or (4) independently developed without access to Proprietary Information.
- 1.4 "Datalogic Product" means the Datalogic® Gryphon™ series scanner product, including all embedded Software in and all Documentation related to such product, which has been purchased or otherwise acquired by End User, whether obtained directly or indirectly from Datalogic.
- 1.5 "Software" means any software or computer programs of Datalogic or its third party licensors in machine readable form which is embedded in the Datalogic Product, whether obtained directly or indirectly from Datalogic, including any replacement, update, upgrade, enhancement or modification.

2. Scope Of License Granted

- 2.1 Datalogic grants to End User a non-exclusive, non-transferable, perpetual license to use the Software, solely on the Datalogic Product in which it is embedded ("designated Datalogic Product"), in machine-readable form only, solely for End User's internal business purposes. This Agreement does not convey ownership of the Software to End User. Title to the Software shall be and remain with Datalogic or the third party from whom Datalogic has obtained a licensed right. As used in this Agreement, the term "purchase" or its equivalents when applied to the Software shall mean "acquire under license." End User is not entitled to receipt or use of the source code to any Software.
- 2.2 End User shall not copy, modify, decompile, disassemble, reverse engineer, or otherwise reproduce or remanufacture the Software, whether modified or unmodified, nor sell, assign, sublicense, distribute, lend, rent, give, or otherwise transfer the Software to any other person or organization, for purposes other than as expressly provided in this Agreement, without Datalogic's prior written consent.

3. Transfers, Support

- 3.1 Any copying, installing, reproduction, remanufacture, reverse engineering, electronic transfer, or other use of the Software on other than the designated Datalogic Product will be a material breach of this Agreement. However, Datalogic may elect not to terminate this Agreement or the granted licenses, but instead

may elect to notify End User that End User is deemed to have ordered and accepted a license for each breaching use. End User shall pay Datalogic the applicable list price for such licenses as of the date of such breach.

- 3.2 End User shall not sell, assign, sublicense, distribute, lend, rent, give, or otherwise transfer the Datalogic Product to any third party unless such third party agrees with Datalogic in writing to be bound by the terms and conditions of this Agreement. Any such transfer of the Datalogic Product absent such agreement shall be null and void.
- 3.3 End User may obtain support for Software from Datalogic at Datalogic's standard support fees and under Datalogic's standard support terms and conditions in effect at the time the support is requested.

4. Intellectual Property

End User acknowledges that the Software constitutes valuable trade secrets of Datalogic or Datalogic's third party licensors and that the Software is protected by intellectual property laws and treaties. The license set forth in this Agreement does not transfer to End User any ownership of Datalogic's or its third party licensors' copyrights, patents, trademarks, service marks, trade secrets, or other intellectual property rights and End User shall have no right to commence any legal actions to obtain such rights. End User shall not remove, modify, or take any other action that would obscure any copyright, trademark, patent marking, or other intellectual property notices contained in or on the Datalogic Product.

5. Proprietary Information

- 5.1 End User acknowledges that Proprietary Information is the confidential, proprietary, and trade secret property of Datalogic and Datalogic's third party licensors and End User acquires no right or interest in any Proprietary Information.
- 5.2 End User shall not disclose, provide, or otherwise make available the Proprietary Information of Datalogic or its third party licensors to any person other than End User's authorized employees or agents who are under confidentiality agreement, and End User shall not use the Proprietary Information other than in conjunction with use of the Datalogic Product exclusively for End User's internal business purposes. End User shall take steps to protect the Proprietary Information no less securely than if it were End User's own intellectual property.
- 5.3 The provisions of this Proprietary Information Section shall survive and continue for five (5) years after the termination of this Agreement.

6. Limited Warranty

- 6.1 Datalogic warrants that, under normal use and operation, the Datalogic Product will conform substantially to the applicable Documentation for the period specified in the Documentation. During this period, for all reproducible nonconformities for which Datalogic has been given written notice, Datalogic will use commercially reasonable efforts to remedy nonconformities verified by Datalogic. End User agrees to supply Datalogic with all reasonably requested information and assistance necessary to help Datalogic in remedying such nonconformities. For all defects reported to Datalogic within the warranty period, Datalogic's liability is limited to providing End User with one copy of corrections or responding to End User's problem reports according to Datalogic's standard assistance practices. Datalogic does not warrant that the product will meet End User's requirements or that use of the product will be uninterrupted or error free, or that Datalogic's remedial efforts will correct any nonconformance. This limited warranty does not cover any product that have been subjected to damage or abuse, whether intentionally, accidentally, or by neglect, or to unauthorized repair or unauthorized installation, and shall be void if End User modifies the product, uses the product in any manner other than as established in the Documentation, or if End User breaches any of the provisions of this Agreement.
- 6.2 EXCEPT AS PROVIDED IN THIS AGREEMENT, THE DATALOGIC PRODUCT IS PROVIDED "AS IS" AND DATALOGIC MAKES NO WARRANTIES OF ANY KIND, EXPRESS OR IMPLIED, WRITTEN OR ORAL, WITH RESPECT TO THE PRODUCT, AND SPECIFICALLY DISCLAIMS THE IMPLIED WARRANTIES OF MERCHANTABILITY AND FITNESS FOR A PARTICULAR PURPOSE.

7. Infringement

- 7.1 Datalogic will defend End User against any claim in a lawsuit that the Datalogic Product furnished hereunder infringe a United States patent or copyright of a third party and Datalogic will pay any damages finally awarded against End User by a court of competent jurisdiction that are attributable to such claim or will pay End User's part of any settlement that is attributable to such claim, provided, that

1) End User notifies Datalogic promptly in writing of the claim, 2) Datalogic controls the defense or settlement of the claim, and 3) End User cooperates fully with Datalogic in such defense or settlement. All notices of a claim should be sent to Datalogic Scanning, Inc., Legal Department, 959 Terry Street, Eugene, OR 97402.

- 7.2 In the defense or settlement of any such claim, Datalogic may, at its option, 1) procure for End User the right to continue using the Datalogic Product, 2) modify the Datalogic Product so that it becomes non-infringing, 3) replace the Datalogic Product with an equivalent product not subject to such claim, or 4) provide End User an opportunity to return the Datalogic Product and receive a refund of the purchase price paid, less a reasonable allowance for use.
- 7.3 Datalogic shall have no liability to End User for claims of infringement based upon 1) the use of any Datalogic Product in combination with any product which Datalogic has not either furnished or authorized for use with such Datalogic Product 2) the use of any Datalogic Product designed, manufactured, or modified to the specifications of End User, or 3) End User's modification of the Datalogic Product without written authorization from Datalogic.
- 7.4 THE FOREGOING STATES DATALOGIC'S COMPLETE AND ENTIRE OBLIGATION CONCERNING CLAIMS OF PATENT, COPYRIGHT, OR OTHER INTELLECTUAL PROPERTY INFRINGEMENT, CANCELS AND SUPERCEDES ANY PRIOR AGREEMENTS, WHETHER ORAL OR WRITTEN, BETWEEN THE PARTIES CONCERNING SUCH CLAIMS, AND WILL NOT BE MODIFIED OR AMENDED BY ANY PAST, CONTEMPORANEOUS, OR FUTURE AGREEMENTS OR DEALINGS BETWEEN THE PARTIES, WHETHER ORAL OR WRITTEN, EXCEPT AS SET FORTH IN A FUTURE WRITING SIGNED BY BOTH PARTIES.

8. Limitation Of Liability

EXCEPT AS PROVIDED IN SECTION 7, DATALOGIC SHALL NOT BE LIABLE FOR ANY CLAIMS AGAINST END USER BY ANY OTHER PARTY. IN NO EVENT SHALL DATALOGIC'S LIABILITY FOR DAMAGES, IF ANY, WHETHER BASED UPON CONTRACT, TORT (INCLUDING NEGLIGENCE), PRODUCT LIABILITY, STRICT LIABILITY, WARRANTY, OR ANY OTHER BASIS, EXCEED THE PRICE OR FEE PAID BY END USER FOR THE DATALOGIC PRODUCT. UNDER NO CIRCUMSTANCES SHALL DATALOGIC BE LIABLE TO END USER OR ANY THIRD PARTY FOR LOST PROFITS, LOST DATA, INTERRUPTION OF BUSINESS OR SERVICE, OR FOR ANY OTHER SPECIAL, CONSEQUENTIAL, CONTINGENT, INDIRECT, INCIDENTAL, PUNITIVE, EXEMPLARY, OR OTHER SIMILAR DAMAGES, EVEN IF DATALOGIC HAS BEEN ADVISED OF THE POSSIBILITY OF SUCH DAMAGES.

9. Government Restricted Rights; International Use

- 9.1 Use, duplication, or disclosure of the Software by the U.S. Government is subject to the restrictions for computer software developed at private expense as set forth in the U.S. Federal Acquisition Regulations at FAR 52.227-14(g), or 52.227-19 or in the Rights in Technical Data and Computer Software clause at DFARS 252.227-7013(c)(1)(ii), whichever is applicable.
- 9.2 If End User is using the Datalogic Product outside of the United States, End User must comply with the applicable local laws of the country in which the Datalogic Product is used, with U.S. export control laws, and with the English language version of this Agreement. The provisions of the "United Nations Convention on International Sale of Goods" shall not apply to this Agreement.

10. Termination

- 10.1 Either party may terminate this Agreement or any license granted under this Agreement at any time upon written notice if the other party breaches any provision of this Agreement.
- 10.2 Upon termination of this Agreement, End User immediately shall cease using any nonembedded software and shall return to Datalogic or destroy all non-embedded software covered by this Agreement, and shall furnish Datalogic with a certificate of compliance with this provision signed by an officer or authorized representative of End User. For embedded software, End User agrees to sign a waiver prepared by Datalogic concerning further use of the embedded Software. End User's resumed or continued use of the embedded Software after termination shall constitute End User's agreement to be bound by the terms and conditions of this Agreement for such use.

11. General Provisions

- 11.1 Entire Agreement; Amendment. This document contains the entire agreement between the parties relating to the licensing of the Software and supersedes all prior or contemporaneous agreements, written or oral, between the parties concerning the licensing of the Software. This Agreement may not be changed, amended, or modified except by written document signed by Datalogic.

- 11.2 Notice. All notices required or authorized under this Agreement shall be given in writing, and shall be effective when received, with evidence of receipt. Notices to Datalogic shall be sent to the attention of Contract Administration, Datalogic Scanning, Inc., 959 Terry Street, Eugene, OR 97402, or such other address as may be specified by Datalogic in writing.
- 11.3 Waiver. A party's failure to enforce any of the terms and conditions of this Agreement shall not prevent the party's later enforcement of such terms and conditions.
- 11.4 Governing Law; Venue: This Agreement and the rights of the parties hereunder shall be governed by and construed in accordance with the laws of the State of Oregon U.S.A, without regard to the rules governing conflicts of law. The state or federal courts of the State of Oregon located in either Multnomah or Lane counties shall have exclusive jurisdiction over all matters regarding this Agreement, except that Datalogic shall have the right, at its absolute discretion, to initiate proceedings in the courts of any other state, country, or territory in which End User resides, or in which any of End User's assets are located.
- 11.5 Attorneys' Fees. In the event an action is brought to enforce the terms and conditions of this Agreement, the prevailing party shall be entitled to reasonable attorneys' fees, both at trial and on appeal.

- END -

Software Product Policy

Datalogic reserves the right to ship its products with the latest version of software/firmware available. This provides our customers with the very latest in Datalogic software technology.

The only exception to this policy is when the buyer has a signed contract with Datalogic that clearly defines the terms and conditions for making software/firmware changes in products shipped to the buyer.

Customers Under Software Support

Customers that elect to subscribe to Datalogic Software Maintenance and Support Agreement will receive 30 days advance notification of: (1) the release of a new software version; and/or (2) discontinuation of any prior software version that will no longer be supported. Datalogic will provide maintenance for a fee that will assist customers in transitioning to the next software version. If a customer is currently using the software version being discontinued, the customer may elect to transition to any one of the newer versions, depending on the hardware in use.

To arrange for a Software Maintenance and Support Agreement please contact your Datalogic sales person.

Gryphon™ I GD44XX

Description

With rich feature sets and extensive model options, the Gryphon™ product series from Datalogic Scanning represents the premium level of data collection equipment for general purpose applications. The Gryphon I GD44XX reader has enhanced optics with improved motion tolerance, allowing codes placed on fast-moving objects to be easily and quickly captured, creating the ideal reader for tasks requiring high throughput like those found in retail and light industrial environments.

Omni-Directional Operating	To read a symbol or capture an image, simply aim the reader and pull the trigger. The Gryphon™ I GD44XX is a powerful omni-directional reader, so the orientation of the symbol is not important. Datalogic's exclusive patented 'Green Spot' for good-read feedback helps to improve productivity in noisy environments or in situations where silence is required. When using the product with the cradle at a 45° position, the aiming pattern can work as an aiming system to aid in positioning the bar code for quick and intuitive reading.
Decoding	Reliably decodes all standard 1D (linear) and 2D bar codes, including GS1 DataBar™ linear codes, Postal Codes (China Post), Stacked Codes (such as GS1 DataBar Expanded Stacked, GS1 DataBar Stacked, GS1 DataBar, Stacked Omnidirectional). The data stream — acquired from decoding a symbol — is rapidly sent to the host. The reader is immediately available to read another symbol.
Imaging	The Gryphon™ I GD44XX can also function as a camera by capturing entire images or image portions of labels, signatures, and other items. See the Datalogic Aladdin configuration tool for information and options for this feature.

Setting Up the Reader

Follow the steps below to connect and get your reader up and communicating with its host.

1. Connect the Cable to the reader and the Host.
2. Configure the Interface (see page 8).
3. Configure the Reader starting on page 20 (optional, depends on settings needed)

Connect/Disconnect Cable to Reader

Figure 1. Connecting to the Reader

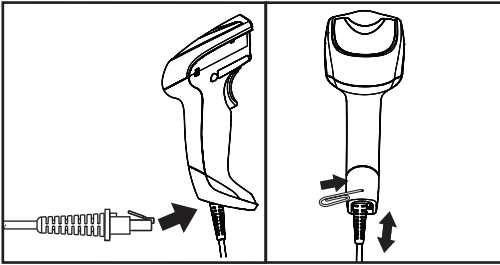

Host Connection: The Gryphon plugs directly into the host device as shown in Figure 2. The power can also be supplied through an external power supply via the Interface Cable supplied with a power jack.

Figure 2. Connecting to the Host

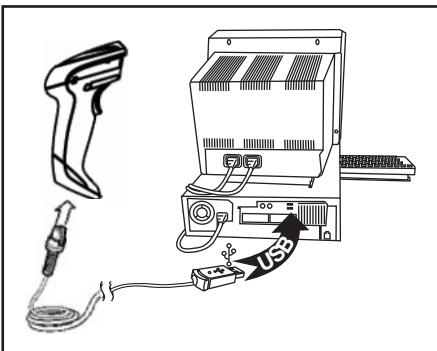

Using the Gryphon™ I GD44XX

The Gryphon™ I GD44XX normally functions by capturing and decoding codes. The reader is equipped with an internal motion-sensing function which activates the aiming system on device motion. The intelligent aiming system indicates the field of view which should be positioned over the bar code:

Aiming System

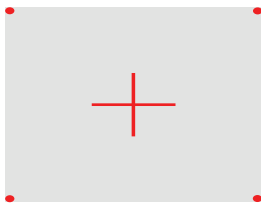

Relative Size and Location of Aiming System Pattern



Linear bar code

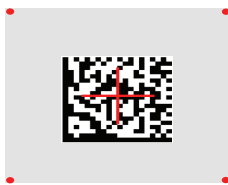

2D Matrix symbol

A red beam illuminates the label. The field of view indicated by the aiming system will be smaller when the reader is closer to the bar code and larger when it is farther from the code. Symbologies with smaller bars or elements (mil size) should be read closer to the unit. Symbologies with larger bars or elements (mil size) should be read farther from the unit.

If the aiming system is centered and the entire bar code is within the aiming field, you will get a good read. Successful reading is signaled by an audible tone plus a good-read green spot LED indicator.

Reference the Gryphon I GD44XX Product Reference Guide (PRG) for more information about this feature and other programmable settings.

Selecting the Interface Type

Upon completing the physical connection between the reader and its host, proceed directly to Interface Selection below for information and programming for the interface type the reader is connected to (for example: RS-232, Keyboard Wedge, USB, etc.) and scan the appropriate bar code to select your system's correct interface type.

Interface Selection

Each reader model will support one of the following sets of host interfaces:

General Purpose Models: RS-232, RS-232 OPOS, USB, Keyboard Wedge, Wand.

Retail Point of Sale Models : RS-232, RS-232 OPOS, USB, IBM 46XX.

Information and programming options for each interface type are provided in this section. For defaults and additional information associated with each interface, proceed to the corresponding chapter in the Gryphon™ 4400 PRG.

Configuring the Interface

Scan the appropriate programming bar code to select the interface type for your system.



Unlike some other programming features and options, interface selections require that you scan only one programming bar code label. DO NOT scan an ENTER/EXIT bar code prior to scanning an interface selection bar code.

Some interfaces require the scanner to start in the disabled state when powered up. If additional scanner configuration is desired while in this state, pull the trigger and hold for 5 seconds. The scanner will change to a state that allows programming with bar codes.

RS-232

RS-232 standard interface



Select RS232-STD

RS-232 Wincor-Nixdorf



Select RS232-WN

RS-232 for use with OPOS/UPOS/JavaPOS



Select RS-232 OPOS

USB Com to simulate RS-232 standard interface



Select USB-COM-STD^a

IBM

IBM-46xx Port 5B reader interface



Select IBM-P5B

IBM-46xx Port 9B reader interface



Select IBM-P9B

USB-OEM

USB-OEM
(can be used for OPOS/UPOS/JavaPOS)



Select USB-OEM

a. Download the correct USB Com driver from www.datalogic.com

Keyboard Interface

Use the programming bar codes to select options for USB Keyboard and Wedge Interfaces.

KEYBOARD

AT, PS/2 25-286, 30-286, 50, 50Z, 60, 70, 80, 90 & 95 w/
Standard Key Encoding



Select KBD-AT

Keyboard Wedge for IBM AT PS2 with standard key encoding but
without external keyboard



Select KBD-AT-NK

AT, PS/2 25-286, 30-286, 50, 50Z, 60, 70, 80, 90 & 95
w/Alternate Key



Select KBD-AT-ALT

Keyboard Wedge for IBM AT PS2 with alternate key encoding but
without external keyboard



Select KBD-AT-ALT-NK

KEYBOARD (continued)

PC/XT w/Standard Key Encoding



Select KBD-XT

Keyboard Wedge for IBM Terminal 3153



Select KBD-IBM-3153

Keyboard Wedge for IBM Terminals 31xx, 32xx, 34xx, 37xx make
only keyboard

Select KBD-IBM-M

Keyboard Wedge for IBM Terminals 31xx, 32xx, 34xx, 37xx make
break keyboard

Select KBD-IBM-MB

USB Keyboard with alternate key encoding



Select USB Alternate Keyboard

USB Keyboard for Apple computers



Select USB-KBD-APPLE

KEYBOARD (continued)

Keyboard Wedge for DIGITAL Terminals
VT2xx, VT3xx, VT4xx



Select KBD-DIG-VT

USB Keyboard with standard key encoding



Select USB Keyboard

WAND EMULATION

Wand Emulation



Select WAND

Scancode Tables

Reference the Gryphon™ 4400 PRG for information about control character emulation for keyboard interfaces.

Country Mode

This feature specifies the country/language supported by the keyboard. Only these interfaces support ALL Country Modes:

- USB Keyboard (without alternate key encoding)
- AT, PS/2 25-286, 30-286, 50, 50Z, 60, 70, 80, 90 & 95 w/Std Key Encoding
- Keyboard Wedge for IBM AT PS2 with standard key encoding but without external keyboard
- AT, PS/2 25-286, 30-286, 50, 50Z, 60, 70, 80, 90 & 95 without Alternate Key
- Keyboard Wedge for IBM AT PS2 without alternate key encoding but without external keyboard

All other interfaces support ONLY the following Country Modes: U.S., Belgium, Britain, France, Germany, Italy, Spain, Sweden.

COUNTRY MODE



ENTER/EXIT PROGRAMMING MODE



Country Mode = U.S.



Country Mode = Belgium



Country Mode = Britain



Country Mode = Croatia*



Country Mode = Czech*

*Supports only the interfaces listed in the Country Mode feature description

COUNTRY MODE (Continued)



Country Mode = Denmark*



Country Mode = France



Country Mode = French Canadian*



Country Mode = Germany



Country Mode = Hungary*

*Supports only the interfaces listed in the Country Mode feature description

COUNTRY MODE (Continued)



Country Mode = Italy



Country Mode = Japanese 106-key*



Country Mode = Lithuanian*



Country Mode = Norway*



Country Mode = Poland*



Country Mode = Portugal*

*Supports only the interfaces listed in the Country Mode feature description

COUNTRY MODE (Continued)



Country Mode = Romania*



Country Mode = Spain



Country Mode = Sweden



Country Mode = Slovakia*



Country Mode = Switzerland*

*Supports only the interfaces listed in the Country Mode feature description

Caps Lock State

This option specifies the format in which the reader sends character data. This applies to keyboard wedge interfaces. This does not apply when an alternate key encoding keyboard is selected.



ENTER/EXIT PROGRAMMING MODE



Caps Lock State = Caps Lock OFF



Caps Lock State = Caps Lock ON



Caps Lock State = AUTO Caps Lock Enable

Numlock

This option specifies the setting of the Numbers Lock (Numlock) key while in keyboard wedge interface. This only applies to alternate key encoding interfaces. It does not apply to USB keyboard.

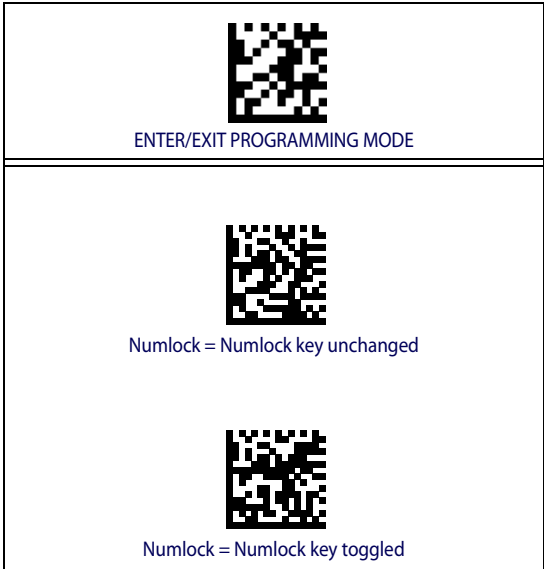

Programming

The reader is factory-configured with a set of standard default features. After scanning the interface bar code from the Interfaces section, select other options and customize your reader through use of the programming bar codes available in the Gryphon I GD44XX PRG. Check the corresponding features section for your interface, and also the Data Editing and Symbolologies chapters of the PRG.

Using Programming Bar Codes

This manual contains bar codes which allow you to reconfigure your reader. Some programming bar code labels, like the "Reset Default Settings" on page 20, require only the scan of that single label to enact the change.

Other bar codes require the reader to be placed in Programming Mode prior to scanning them. Scan an ENTER/EXIT bar code once to enter Programming Mode; scan the desired parameter settings; scan the ENTER/EXIT bar code again to accept your changes, which exits Programming Mode and returns the reader to normal operation.

Configure Other Settings

Additional programming bar codes are available in the PRG to allow for customizing programming features. If your installation requires different programming than the standard factory default settings, refer to the PRG.

Resetting Product Defaults

If you aren't sure what programming options are in your reader, or you've changed some options and want your custom factory settings restored, scan the bar code below to reset the reader to its initial configuration. Reference the PRG for other options, and a listing of standard factory settings.



Factory defaults are based on the interface type. Be sure your reader is configured for the correct interface before scanning this label. See "Selecting the Interface Type" on page 8 for more information.



Reset Default Settings

Reading Parameters

Move the reader toward the target and center the aiming pattern and illumination system to capture and decode the image. See [Using the Gryphon™ I GD44XX on page 7](#) for more information.

The aiming system will briefly switch off after the acquisition time, and if no code is decoded will switch on again before the next acquisition. The illuminator will remain on until the symbol is decoded.

As you read code symbols, adjust the distance at which you are holding the reader.

Aiming System

A number of options for customizing control of the Aiming System are available. See the Gryphon I GD44XX PRG for more information and programming bar codes.

Good Read Green Spot Duration

Successful reading can be signaled by a good read green spot. Use the bar codes that follow to specify the duration of the good read pointer beam after a good read.



ENTER/EXIT PROGRAMMING MODE



Disabled



◆ Short (300 ms)



Medium (500 ms)



Long (800 ms)

Operating Modes

Scan Mode

The imager can be set to operate in one of several scanning modes. See the PRG for more information and settings for any of the options:

Trigger Single (Default): This mode is associated with typical handheld reader operation. Motion Sense is active and if the scanner detects motion the aiming pattern is turned on. When the trigger is pulled, illumination is turned on and the scanner attempts to read a label. Scanning is activated until one of the following occurs:

- the programmable “maximum scan on time”¹ has elapsed
- a label has been read
- the trigger is released

Trigger Pulse Multiple: Scanning begins when the trigger is pulled and continues after the trigger is released, until the trigger is pulled again or until the programmable “maximum scan on time”¹ has elapsed. Reading a label does not disable scanning. Double Read Timeout¹ prevents undesired multiple reads while in this mode.

Trigger Hold Multiple : When the trigger is pulled, scanning starts and the product scans until the trigger is released or “maximum scan on time”¹ has elapsed. Reading a label does not disable scanning. Double Read Timeout¹ prevents undesired multiple reads while in this mode.

Always On: The illuminator is always ON and the reader is always ready for code reading. Double Read Timeout¹ prevents undesired multiple reads.

Flashing: The reader illuminator flashes on and off regardless of the trigger status. Code reading takes place only during the Flash On² time. Double Read Timeout¹ prevents undesired multiple reads.

Object Detection³: The scanner looks for changes within its field-of-view. The Aiming Pattern is always on to show the optimum reading area. If a predefined amount of movement is detected, the red illumination switches on. Scanning continues until a label is read or “maximum scan on time” is reached.

1. See the Product Reference Guide (PRG) for these and other programmable features
2. Controlled by Flash On Time and Flash Off Time. Use the PRG to program these options.
3. This feature is available starting with firmware release 610001013.

Scan Mode (continued)



ENTER/EXIT PROGRAMMING MODE



◆ Scan Mode = Trigger Single



Scan Mode = Trigger Pulse Multiple



Scan Mode = Trigger Hold Multiple



Scan Mode = Flashing



Scan Mode = Always On



Scan Mode = Object Detection*

* This feature is available starting with firmware release 610001013

Stand Mode Operation

Stand Mode: In Stand Mode, the illumination remains on for a configurable amount of time after a good read occurs. The scanner exits stand mode when movement is detected. If the trigger is activated from stand mode, the scanner transitions into one of the triggered modes.



This feature is available starting with firmware release 610001013.



ENTER/EXIT PROGRAMMING MODE



◆ Stand Mode = Disabled



Stand Mode = Generic Stand



Stand Mode = for All-in-one and Base



Stand Mode = Precise Stand

Pick Mode

Specifies the ability of the reader to decode labels only when they are close to the center of the aiming pattern. Pick Mode is a Decoding and Transmission process where bar codes that are not within the configurable distance from the center of the aiming pattern are not acknowledged or transmitted to the host. It is active only while the scanner is in Trigger Single mode. If the scanner switches to a different Read Mode, Pick Mode is automatically disabled.



This feature is not compatible with Multiple Labels Reading in a Volume. See the PRG for more information.



ENTER/EXIT PROGRAMMING MODE



◆ Pick Mode = Disable



Pick Mode = Enable

Multiple Label Reading

The reader offers a number of options for multiple label reading. See the PRG or software configuration tool for descriptions of these features and programming labels.

Technical Specifications

The following table contains Physical and Performance Characteristics, User Environment and Regulatory information.

Item	Description
Physical Characteristics	
Color	Black
Dimensions	Height 7.1"/181 mm Length 3.9"/100 mm Width 2.8"/71 mm
Weight (without cable)	Approximately 6.9 ounces /195.6 g
Electrical Characteristics	
Voltage & Current	Input Voltage <ul style="list-style-type: none"> • GD441X: 4.0 - 14.0VDC • GD443X: 4.2 - 5.25VDC Operating (typical) <ul style="list-style-type: none"> • GD441X- 170ma • GD443X - 160ma Operating (max) <ul style="list-style-type: none"> • GD441X- 385ma • GD443X - 350ma Idle/standby (typical) <ul style="list-style-type: none"> • GD441X - 65ma • GD443X - 65ma
Performance Characteristics	
Light Source	LEDs
Roll (Tilt) Tolerance	Up to $\pm 180^\circ$
Pitch Tolerance	$\pm 40^\circ$
Skew (Yaw) Tolerance	$\pm 40^\circ$
Print Contrast Minimum	25% minimum reflectance

Depth of Field (Typical)^a		
Symbology	SR:	HD:
Code 39	5mil: 1.6" - 7.5" (4.0 - 19cm) 10mil: 0.4" - 11.8" (1.0 - 30cm) 20mil: up to 17.7" (up to 45cm)	3mil: 0.9" - 3.6" (2.4 - 9.1cm) 5 mil: 0.3" - 4.5" (0.8 - 11.3cm)
EAN	7.5mil: 0.5" - 10.6" (2.0 - 27cm) 13mil: 0.6" - 15.7" (1.5 - 40cm)	7.5mil: 0" - 5" (0 - 12.7cm) 13mil: .43" - 6.8" (1.1 - 17.2cm)
PDF-417	6.6mil: 1.0" - 5.9" (2.5 - 15cm) 10mil: 0.2" - 8.6" (0.5 - 22cm) 15mil: 0.6" - 13.4" (1.5 - 34cm)	4mil: 0.7" - 2.7" (1.8 - 6.8cm) 6.6mil: 0.1" - 4.4" (0.1 - 11.2cm) 10mil: 0" - 5.6" (0 - 14.3cm)
DataMatrix	10mil: 0.8" to 6.3" (2.0 - 16cm) 15mil: 0" to 9.3" (0 - 23.6cm)	5mil: 1.1" - 2.4" (2.8-6.1cm)
QR Code	10mil: 1.2" to 4.9" (3.0 - 12.5cm) 15mil: 0.4" to 7.5" (1.0 - 19cm)	6.7mil: 0.8" - 1.7" (2.1 - 4.2cm)
Minimum Element Width	Standard Range: 1D Min Resolution = 4 mil PDF-417 Min Resolution = 5 mil Datamatrix Min Resolution = 7 mil	High Density: 1D Min Resolution = 2.5 mil PDF-417 Min Resolution = 4 mil Datamatrix Min Resolution = 5 mil

- a. 13 mils DOF based on EAN. All other 1D codes are Code 39. All labels grade A, typical environmental light, 20°C, label inclination 10°

Decode Capability	
<p>1D Bar Codes UPC/EAN/JAN (A, E, 13, 8); UPC/EAN/JAN (including P2 /P5); UPC/EAN/JAN (including; ISBN / Bookland & ISSN); UPC/EAN Coupons; Code 39 (including full ASCII); Code 39 Trioptic; Code39 CIP (French Pharmaceutical); LOGMARS (Code 39 w/ standard check digit enabled); Danish PPT; Code 32 (Italian Pharmacode 39); Code 128; Code 128 ISBT; Interleaved 2 of 5; Standard 2 of 5; Interleaved 2 of 5 CIP (HR); Industrial 2 of 5; Discrete 2 of 5; Datalogic 2 of 5 (China Post Code/Chinese 2 of 5); IATA 2of5 Air cargo code; Code 11; Codabar; Codabar (NW7); ABC Codabar; EAN 128; Code 93; MSI; PZN; Plessey; Anker Plessey; GS1 DataBar Omnidirectional; GS1 DataBar Limited; GS1 DataBar Expanded; GS1 DataBar Truncated; DATABAR Expanded Coupon.</p>	
<p>2D / Stacked Codes The Gryphon I GD44XX scanner is capable of decoding the following symbologies using multiple frames (i.e. Multi-Frame Decoding): Datamatrix; Inverse Datamatrix; Datamatrix is configurable for the following parameters;; Normal or Inverted; Square or Rectangular Style; Data length (1 - 3600 characters); Maxicode; QR Codes (QR, Micro QR and Multiple QR Codes); Aztec; Postal Codes - (Australian Post; Japanese Post; KIX Post; Planet Code; Postnet; Royal Mail Code (RM45CC); Intelligent Mail Barcode (IMB); Sweden Post; Portugal Post); LaPoste A/R 39; 4-State Canada; PDF-417; MacroPDF; Micro PDF417; GS1 Composites (1 - 12); Codablock F; French CIP13^a; GS1 DataBar Stacked; GS1 DataBar Stacked Omnidirectional; GS1 DataBar Expanded Stacked; GSI Databar Composites; Chinese Sensible Code; Inverted 2D codes^b.</p> <p>^aIt is acceptable to handle this with ULE ^bThe SW can apply the Normal/Reverse Decoding Control to the following symbologies: Datamatrix, QR, Micro QR, Aztec and Chinese Sensible Code.</p>	
Interfaces Supported	USB Com Std., USB Keyboard, USB See page 8 for a listing of available interface options.
User Environment	
Operating Temperature	32° to 131° F (0° to 55° C)
Storage Temperature	-4° to 158° F (-20° to 70° C)
Humidity	Operating: 5% to 90% relative humidity, non-condensing
Drop Specifications	Scanner withstands 18 drops from 1.8 meters (6.0 feet) to concrete
Ambient Light Immunity	Up to 100,000 Lux
Contaminants Spray/rain Dust/particulates	IEC 529-IP52

ESD Level	16 KV
Regulatory	
Electrical Safety	UL 60950, CSA C22.2 No. 60950, IEC 60950
EMI/RFI	North America (FCC) : Part 15 Class B; Canada (IC) : ICES-003 Class B; Russia (Gost); European Union EMC Directive; VCCI-Japan; Korean KCC; Taiwan EMC (BSMI); Australia (ACMA)
Laser Class Safety	IEC Class 2 Radiation 1 mW Avg., Emitted wavelength 650 nm, 12ms pulse, Beam Divergence 8.4 deg x 8.1 deg ("plus" pattern)
Complies with FDA performance standards for laser products except for deviations pursuant to Laser Notice No. 50, dated June 24, 2007.	

LED and Beeper Indications

The reader's beeper sounds and its LED illuminates to indicate various functions or errors on the reader. An optional "Green Spot" also performs useful functions. The following tables list these indications. One exception to the behaviors listed in the tables is that the reader's functions are programmable, and so may or may not be turned on. For example, certain indications such as the power-up beep can be disabled using programming bar code labels.

Indicator	Description	LED	Beeper
Power-up Beep	The reader is in the process of power-ing-up.		Reader beeps four times at highest frequency and volume upon power-up.
Good Read Beep	A label has been successfully scanned by the reader.	LED behavior for this indication is configurable via the feature "Good Read: When to Indicate" (see the PRG for information.)	The reader will beep once at current frequency, volume, mono/bi-tonal setting and duration upon a successful label scan.

Indicator	Description	LED	Beeper
ROM Failure	There is an error in the reader's software/programming	Flashes	Reader sounds one error beep at highest volume.
Limited Scanning Label Read	Indicates that a host connection is not established.	N/A	Reader 'chirps' six times at the highest frequency and current volume.
Reader Active Mode	The reader is active and ready to scan.	The LED is lit steadily ^a	N/A
Reader Disabled	The reader has been disabled by the host.	The LED blinks continuously	N/A
Green Spot ^a flashes momentarily	Upon successful read of a label, the software shall turn the green spot on for the time specified by the configured value.	N/A	N/A
Image Capture	When ready to capture image	Blue light flashes 2 times when updating	N/A

^aExcept when in sleep mode or when a Good Read LED Duration other than 00 is selected

Programming Mode - The following indications **ONLY** occur when the reader is in Programming Mode.

INDICATION	DESCRIPTION	LED	BEEPER
Label Programming Mode Entry	A valid programming label has been scanned.	LED blinks continuously	Reader sounds four low frequency beeps.
Label Programming Mode Rejection of Label	A label has been rejected.	N/A	Reader sounds three times at lowest frequency and current volume.
Label Programming Mode Acceptance of Partial Label	In cases where multiple labels must be scanned to program one feature, this indication acknowledges each portion as it is successfully scanned.	N/A	Reader sounds one short beep at highest frequency and current volume.
Label Programming Mode Acceptance of Programming	Configuration option(s) have been successfully programmed via labels and the reader has exited Programming Mode.	N/A	Reader sounds one high frequency beep and 4 low frequency beeps followed by reset beeps.
Label Programming Mode Cancel Item Entry	Cancel label has been scanned.	N/A	Reader sounds two times at low frequency and current volume.

Error Codes

Upon startup, if the reader sounds a long tone, this means the reader has not passed its automatic Selftest and has entered FRU (Field Replaceable Unit) isolation mode. If the reader is reset, the sequence will be repeated. Press and release the trigger to hear the FRU indication code.

The following table describes the LED flashes/beep codes associated with an error found.

Number of LED Flashes/Beeps	Error	Corrective Action
1	Configuration	Contact Helpdesk for assistance
2	Interface PCB	
6	Digital PCB	
11	Imager	

Cleaning

Exterior surfaces and scan windows exposed to spills, smudges or debris require periodic cleaning to ensure best performance during scanning.

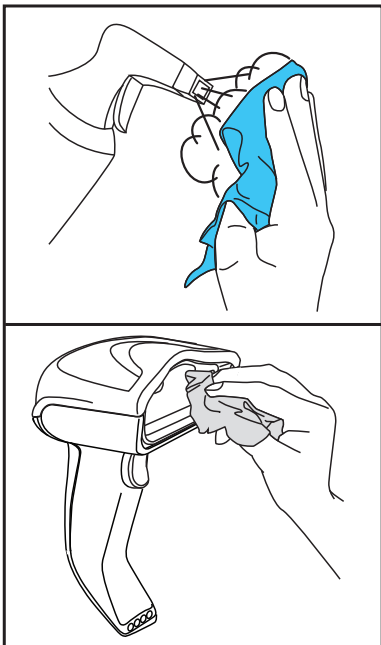

Use a soft, dry cloth to clean the product. If the product is very soiled, clean it with a soft cloth moistened with a diluted non-aggressive cleaning solution or diluted ethyl alcohol.



CAUTION

Do not use abrasive or aggressive cleansing agents or abrasive pads to clean scan windows or plastics.

Do not spray or pour liquids directly onto the unit.

Regulatory Information

All models are designed to be compliant with rules and regulations in locations they are sold and will be labeled as required.

Any changes or modifications to equipment, not expressly approved by Datalogic could void the user's authority to operate the equipment.

Statement of Agency Compliance

This device complies with part 15 of the FCC Rules. Operation is subject to the following two conditions: (1) this device may not cause harmful interference, and (2) this device must accept any interference received, including interference that may cause undesired operation.

FCC Class B Compliance Statement

The user is cautioned that changes or modifications not expressly approved by the part responsible for compliance could void the user's authority to operate the equipment.

This equipment has been tested and found to comply with the limits for a Class B digital device pursuant to part 15 of the FCC Rules. These limits are designed to provide reasonable protection against harmful interference in a residential installation. This equipment generates, uses, and can radiate radio frequency energy and, if not installed and used in accordance with the instructions, may cause harmful interference to radio communications. However, there is no guarantee that interference will not occur in a particular installation. If this equipment does cause harmful interference to radio or television reception, which can be determined by turning the equipment off and on, the user is encouraged to try to correct the interference by one or more of the following measures:

- Reorient or relocate the receiving antenna.
- Increase the separation between the equipment and receiver.
- Connect the equipment into an outlet on a circuit different from that to which the receiver is connected.
- Consult the dealer or an experienced radio or television technician for help.

Canadian Notice

This equipment does not exceed the Class B limits for radio noise emissions as described in the Radio Interference Regulations of the Canadian Department of Communications.

Le present appareil numerique n'emet pas de bruits radioelectriques depassant les limites applicables aux appareils numeriques de la classe B prescrites dans le Reglement sur le brouillage radioelectrique edicte par le ministere des Communications du Canada.



Do not attempt to open or otherwise service any components in the optics cavity. Opening or servicing any part of the optics cavity by unauthorized personnel may violate laser safety regulations.

Power Supply

This device is intended to be connected to a UL Listed/CSA Certified computer which supplies power directly to the reader or else be supplied by UL Listed/CSA Certified Power Unit marked "Class 2" or LPS power source rated 5-14V minimum 900mA.

Imager Labeling

Sample labels are shown here to illustrate their location only. Please view the labels on your product for actual details, as they may vary from those depicted.

Scanner Regulatory Label

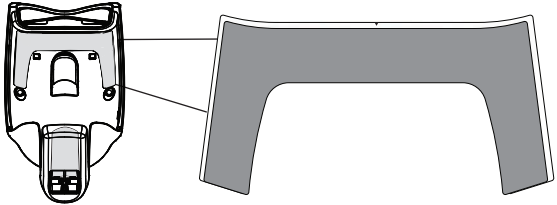

Aiming System

The Gryphon™ aiming system meets the Class 2 requirements for laser safety. The laser information is located on the window of the Scanner as shown below.

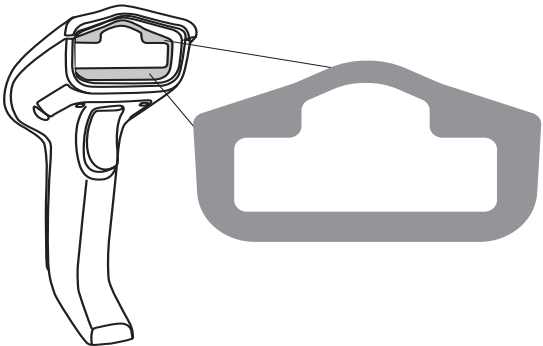

I	D	F	E
LA LUCE LASER È VISIBILE ALL'OCCHIO UMANO E VIENE EMESSA DALLA FINESTRA INDICATA NELLA FIGURA.	DIE LASER-STRAHLUNG IST FÜR DAS MENSCHLICHE AUGE SICHTBAR UND WIRD AM STRAHLAUS TRITTSFENSTER AUSGESENDET (SIEHE BILD)	LE RAYON LASER EST VISIBLE À L'OEIL NU ET IL EST ÉMIS PAR LA FENÊTRE DÉSIGNÉE SUR L'ILLUSTRATION DANS LA FIGURE	A LUZ LÁSER ES VISIBLE AL OJO HUMANO Y ES EMITIDA POR LA VENTANA INDICADA EN LA FIGURA.
LUCE LASER NON FISSARE IL FASCIO APPARECCHIO LASER DI CLASSE 2 MASSIMA POTENZA D'USCITA: LUNGHEZZA D'ONDA EMESSA: CONFORME A EN 60825-1 (2007)	LASERSTRAHLUNG NICHT IN DEN STRAHL BLICKEN PRODUKT DER LASERKLASSE 2 MAXIMALE AUSGANGSLEISTUNG: WELLENLÄGE: ENTSPR. EN 60825-1 (2007)	RAYON LASER EVITER DE REGARDER LE RAYON APPAREIL LASER DE CLASSE 2 PUIS-SANCE DE SORTIE: LONGUEUR D'ONDE EMISE: CONFORME A EN 60825-1 (2007)	RAYO LÁSER NO MIRAR FIJO EL RAYO APARATO LÁSER DE CLASE 2 MÁXIMA POTENCIA DE SALIDA: LONGITUD DE ONDA EMITIDA: CONFORME A EN 60825-1 (2007)

ENGLISH

The following information is provided to comply with the rules imposed by international authorities and refers to the correct use of your terminal.

STANDARD LASER SAFETY REGULATIONS

This product conforms to the applicable requirements of both CDRH 21 CFR 1040 and EN 60825-1 at the date of manufacture.

For installation, use and maintenance, it is not necessary to open the device.



WARNING

Use of controls or adjustments or performance of procedures other than those specified herein may result in exposure to hazardous visible laser light.

The product utilizes a low-power laser diode. Although staring directly at the laser beam momentarily causes no known biological damage, avoid staring at the beam as one would with any very strong light source, such as the sun. Avoid that the laser beam hits the eye of an observer, even through reflective surfaces such as mirrors, etc.

ITALIANO

Le seguenti informazioni vengono fornite dietro direttive delle autorità internazionali e si riferiscono all'uso corretto del terminale.

NORMATIVE STANDARD PER LA SICUREZZA LASER

Questo prodotto risulta conforme alle normative vigenti sulla sicurezza laser alla data di produzione: CDRH 21 CFR 1040 e EN 60825-1.

Non si rende mai necessario aprire l'apparecchio per motivi di installazione, utilizzo o manutenzione.



ATTENZIONE

L'utilizzo di procedure o regolazioni differenti da quelle descritte nella documentazione può provocare un'esposizione pericolosa a luce laser visibile.

Il prodotto utilizza un diodo laser a bassa potenza. Sebbene non siano noti danni riportati dall'occhio umano in seguito ad una esposizione di breve durata, evitare di fissare il raggio laser così come si eviterebbe qualsiasi altra sorgente di luminosità intensa, ad esempio il sole. Evitare inoltre di dirigere il raggio laser negli occhi di un osservatore, anche attraverso superfici riflettenti come gli specchi.

DEUTSCH

Die folgenden Informationen stimmen mit den Sicherheitshinweisen überein, die von internationalen Behörden auferlegt wurden, und sie beziehen sich auf den korrekten Gebrauch vom Terminal.

NORM FÜR DIE LASERSICHERHEIT

Dies Produkt entspricht am Tag der Herstellung den gültigen EN 60825-1 und CDRH 21 CFR 1040 Normen für die Lasersicherheit.

Es ist nicht notwendig, das Gerät wegen Betrieb oder Installations-, und Wartungs-Arbeiten zu öffnen.



ACHTUNG

Jegliche Änderungen am Gerät sowie Vorgehensweisen, die nicht in dieser Betriebsanleitung beschrieben werden, können ein gefährliches Laserlicht verursachen.

Der Produkt benutzt eine Laserdiode. Obwohl zur Zeit keine Augenschäden von kurzen Einstrahlungen bekannt sind, sollten Sie es vermeiden für längere Zeit in den Laserstrahl zu schauen, genauso wenig wie in starke Lichtquellen (z.B. die Sonne). Vermeiden Sie es, den Laserstrahl weder gegen die Augen eines Beobachters, noch gegen reflektierende Oberflächen zu richten.

FRANÇAIS

Les informations suivantes sont fournies selon les règles fixées par les autorités internationales et se réfèrent à une correcte utilisation du terminal.

NORMES DE SECURITE LASER

Ce produit est conforme aux normes de sécurité laser en vigueur à sa date de fabrication: CDRH 21 CFR 1040 et EN 60825-1.

Il n'est pas nécessaire d'ouvrir l'appareil pour l'installation, l'utilisation ou l'entretien.



ATTENTION

L'utilisation de procédures ou réglages différents de ceux donnés ici peut entraîner une dangereuse exposition à lumière laser visible.

Le produit utilise une diode laser. Aucun dommage aux yeux humains n'a été constaté à la suite d'une exposition au rayon laser. Eviter de regarder fixement le rayon, comme toute autre source lumineuse intense telle que le soleil. Eviter aussi de diriger le rayon vers les yeux d'un observateur, même à travers des surfaces réfléchissantes (miroirs, par exemple).

ESPAÑOL

Las informaciones siguientes son presentadas en conformidad con las disposiciones de las autoridades internacionales y se refieren al uso correcto del terminal.

NORMATIVAS ESTÁNDAR PARA LA SEGURIDAD LÁSER

Este aparato resulta conforme a las normativas vigentes de seguridad láser a la fecha de producción: CDRH 21 CFR 1040 y EN 60825-1.

No es necesario abrir el aparato para la instalación, la utilización o la manutención.



ATENCIÓN

La utilización de procedimientos o regulaciones diferentes de aquellas descritas en la documentación puede causar una exposición peligrosa a la luz láser visible.

El aparato utiliza un diodo láser a baja potencia. No son notorios daños a los ojos humanos a consecuencia de una exposición de corta duración. Eviten de mirar fijo el rayo láser así como evitarían cualquiera otra fuente de luminosidad intensa, por ejemplo el sol. Además, eviten de dirigir el rayo láser hacia los ojos de un observador, también a través de superficies reflectantes como los espejos.



CAUTION

The Gryphon™ Handheld Reader is not user-serviceable. Opening the case of the unit can cause internal damage and will void the warranty.

WEEE Statement

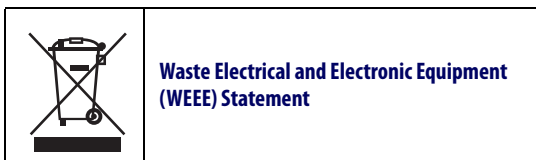

English

For information about the disposal of Waste Electrical and Electronic Equipment (WEEE), please refer to the website at www.scanning.datalogic.com.

Italian

Per informazioni sullo smaltimento delle apparecchiature elettriche ed elettroniche consultare il sito Web www.scanning.datalogic.com.

French

Pour toute information relative à l'élimination des déchets électroniques (WEEE), veuillez consulter le site internet www.scanning.datalogic.com.

German

Informationen zur Entsorgung von Elektro- und Elektronik- Altgeräten (WEEE) erhalten Sie auf der Webseite www.scanning.datalogic.com.

Spanish

Si desea información acerca de los procedimientos para el desecho de los residuos del equipo eléctrico y electrónico (WEEE), visite la página Web www.scanning.datalogic.com.

Portuguese

Para informações sobre a disposição de Sucatagem de Equipamentos Elétricos e Eletrônicos (WEEE -Waste Electrical and Electronic Equipment), consultar o site web www.scanning.datalogic.com.

Chinese

有关处理废弃电气电子设备 (WEEE) 的信息, 请参考 Datalogic 公司的网站 www.scanning.datalogic.com/。

Japanese

廃電気電子機器 (WEEE) の処理についての関連事項は Datalogic のサイト www.scanning.datalogic.com をご参照下さい。

Datalogic Scanning Limited Factory Warranty

Warranty Coverage

Datalogic warrants to Customer that Datalogic's products will be free from defects in materials and workmanship for a period of one year from product shipment. Datalogic Scanning ("Datalogic") hardware products are warranted against defects in material and workmanship under normal and proper use. The liability of Datalogic under this warranty is limited to furnishing the labor and parts necessary to remedy any defect covered by this warranty and restore the product to its normal operating condition. Repair or replacement of product during the warranty does not extend the original warranty term. Products are sold on the basis of specifications applicable at the time of manufacture and Datalogic has no obligation to modify or update products once sold.

If Datalogic determines that a product has defects in material or workmanship, Datalogic shall, at its sole option repair or replace the product without additional charge for parts and labor, or credit or refund the defective products duly returned to Datalogic. To perform repairs, Datalogic may use new or reconditioned parts, components, subassemblies or products that have been tested as meeting applicable specifications for equivalent new material and products. Customer will allow Datalogic to scrap all parts removed from the repaired product. The warranty period shall extend from the date of shipment from Datalogic for the duration published by Datalogic for the product at the time of purchase (Warranty period). Datalogic warrants repaired hardware devices against defects in workmanship and materials on the repaired assembly for a 90 day period starting from the date of shipment of the repaired product from Datalogic or until the expiration of the original warranty period, whichever is longer. Datalogic does not guarantee, and it is not responsible for, the maintenance of, damage to, or loss of configurations, data, and applications on the repaired units and at its sole discretion can return the units in the "factory default" configuration or with any software or firmware update available at the time of the repair (other than the firmware or software installed during the manufacture of the product). Customer accepts responsibility to maintain a back up copy of its software and data.

Warranty Claims Process

In order to obtain service under the Factory Warranty, Customer must notify Datalogic of the claimed defect before the expiration of the applicable Warranty period and obtain from Datalogic a return authorization number (RMA) for return of the product to a designated Datalogic service center. If Datalogic determines Customer's claim is valid, Datalogic will repair or replace product without additional charge for parts and labor. Customer shall be responsible for packaging and shipping the product to the designated Datalogic service center, with shipping charges prepaid. Datalogic shall pay for the return of the product to Customer if the shipment is to a location within the country in which the Datalogic service center is located. Customer shall be responsible for paying all shipping charges, duties, taxes, and any other charges for products returned to any other locations. Failure to follow the applicable RMA policy, may result in a processing fee. Customer shall be responsible for return shipment expenses for products which Datalogic, at its sole discretion, determines are not defective or eligible for warranty repair.

Warranty Exclusions

The Datalogic Factory Warranty shall not apply to:

- (i) any product which has been damaged, modified, altered, repaired or upgraded by other than Datalogic service personnel or its authorized representatives;
- (ii) any claimed defect, failure or damage which Datalogic determines was caused by faulty operations, improper use, abuse, misuse, wear and tear, negligence, improper storage or use of parts or accessories not approved or supplied by Datalogic;
- (iii) any claimed defect or damage caused by the use of product with any other instrument, equipment or apparatus;
- (iv) any claimed defect or damage caused by the failure to provide proper maintenance, including but not limited to cleaning the upper window in accordance with product manual;
- (v) any defect or damage caused by natural or man-made disaster such as but not limited to fire, water damage, floods, other natural disasters, vandalism or abusive events that would cause internal and external component damage or destruction of the whole unit, consumable items;
- (vi) any damage or malfunctioning caused by non-restoring action as for example firmware or software upgrades, software or hardware reconfigurations etc.;
- (vii) the replacement of upper window/cartridge due to scratching, stains or other degradation and/or
- (viii) any consumable or equivalent (e.g., cables, power supply, batteries, keypads, touch screen, triggers etc.).

No Assignment

Customer may not assign or otherwise transfer its rights or obligations under this warranty except to a purchaser or transferee of product. No attempted assignment or transfer in violation of this provision shall be valid or binding upon Datalogic.

DATALOGIC'S LIMITED WARRANTY IS IN LIEU OF ALL OTHER WARRANTIES, EXPRESS OR IMPLIED, ORAL OR WRITTEN, STATUTORY OR OTHERWISE, INCLUDING, WITHOUT LIMITATION, ANY IMPLIED WARRANTIES OF MERCHANTABILITY, FITNESS FOR A PARTICULAR PURPOSE, OR NON-INFRINGEMENT. DATALOGIC SHALL NOT BE LIABLE FOR ANY DAMAGES SUSTAINED BY CUSTOMER ARISING FROM DELAYS IN THE REPLACEMENT OR REPAIR OF PRODUCTS UNDER THE ABOVE. THE REMEDY SET FORTH IN THIS WARRANTY STATEMENT IS THE CUSTOMER'S SOLE AND EXCLUSIVE REMEDY FOR WARRANTY CLAIMS. UNDER NO CIRCUMSTANCES WILL DATALOGIC BE LIABLE TO CUSTOMER OR ANY THIRD PARTY FOR ANY LOST PROFITS, OR ANY INCIDENTAL, CONSEQUENTIAL IN-DIRECT, SPECIAL OR CONTINGENT DAMAGES REGARDLESS OF WHETHER DATALOGIC HAD ADVANCE NOTICE OF THE POSSIBILITY OF SUCH DAMAGES.

Risk of Loss

Customer shall bear risk of loss or damage for product in transit to Datalogic. Datalogic shall assume risk of loss or damage for product in Datalogic's possession. In the absence of specific written instructions for the return of product to Customer, Datalogic will select the carrier, but Datalogic shall not thereby assume any liability in connection with the return shipment.

Ergonomic Recommendations



CAUTION

In order to avoid or minimize the potential risk of ergonomic injury follow the recommendations below. Consult with your local Health & Safety Manager to ensure that you are adhering to your company's safety programs to prevent employee injury.

- Reduce or eliminate repetitive motion
- Maintain a natural position
- Reduce or eliminate excessive force
- Keep objects that are used frequently within easy reach
- Perform tasks at correct heights
- Reduce or eliminate vibration
- Reduce or eliminate direct pressure
- Provide adjustable workstations
- Provide adequate clearance
- Provide a suitable working environment
- Improve work procedures.

Services and Support

Datalogic provides several services as well as technical support through its website. Log on to **www.scanning.datalogic.com** and click on the links indicated for further information.

Products

Search through the links to arrive at your product page where you can download specific **Manuals** and **Software & Utilities**, including:

- **Datalogic Aladdin™**, a multi-platform utility program that allows device configuration using a PC. It provides RS-232 interface configuration as well as configuration bar code printing.

Service & Support

- **Technical Support** - Product documentation and programming guides and Technical Support Department in the world
- **Service Programs** - Warranty Extensions and Maintenance Agreements
- **Repair Services** - Flat Rate Repairs and Return Material Authorization (RMA) Repairs
- **Downloads** – Manuals & Documentation, Data Sheets, Product Catalogues, etc.

Contact Us

- Information Request Form and Sales & Service Network

NOTES

DECLARATION OF CONFORMITY



EC-65

Rev.: 0

Pag.: 1 di 1

Datalogic Scanning, Inc.
959 Terry St.
Eugene, OR 97402
USA

dichiara che
declares that the
déclare que le
bescheinigt, daß das Gerät
declare que el

Gryphon GD4400; Barcode Reader

e tutti i suoi modelli
and all its models
et tous ses modèles
und seine Modelle
y todos sus modelos

sono conformi alle Direttive del Consiglio Europeo sottoelencate:
are in conformity with the requirements of the European Council Directives listed below:
sont conformes aux spécifications des Directives de l'Union Européenne ci-dessous:
den nachstehenden angeführten Direktiven des Europäischen Rats:
cumple con los requisitos de las Directivas del Consejo Europeo, según la lista siguiente:

2004/108/EC EMC Directive **2006/95/EC Low Voltage Directive**

Basate sulle legislazioni degli Stati membri in relazione alla compatibilità elettromagnetica ed alla sicurezza dei prodotti.

On the approximation of the laws of Member States relating to electromagnetic compatibility and product safety.

Basée sur la législation des Etats membres relative à la compatibilité électromagnétique et à la sécurité des produits.

Über die Annäherung der Gesetze der Mitgliedsstaaten in bezug auf elektromagnetische Verträglichkeit und Produktsicherheit entsprechen.

Basado en la aproximación de las leyes de los Países Miembros respecto a la compatibilidad electromagnética y las Medidas de seguridad relativas al producto.

Questa dichiarazione è basata sulla conformità dei prodotti alle norme seguenti:

This declaration is based upon compliance of the products to the following standards:

Cette déclaration repose sur la conformité des produits aux normes suivantes:

Diese Erklärung basiert darauf, daß das Produkt den folgenden Normen entspricht:

Esta declaración se basa en el cumplimiento de los productos con las siguientes normas:

EN 55022 (CLASS B ITE), SEPTEMBER 2006: LIMITS AND METHODS OF MEASUREMENTS OF RADIO DISTURBANCE
AMMENDMENT A1: OCTOBER 2007 CHARACTERISTICS OF INFORMATION TECHNOLOGY EQUIPMENTS

EN 55024, SEPTEMBER 1998 : INFORMATION TECHNOLOGY EQUIPMENT
AMENDMENT A2, JUNE 2003 IMMUNITY CHARACTERISTICS

LIMITS AND METHODS OF MEASUREMENT

EN 60950-1, APRIL 2006+A11:2009 : INFORMATION TECHNOLOGY EQUIPMENT - SAFETY -
PART 1 : GENERAL REQUIREMENTS

EUGENE, OREGON USA
FEBRUARY 18, 2011



Brad West
Vice President, Supply Chain Operations

Australia

Datalogic Scanning Pty Ltd
Telephone: [61] (2) 9870 3200
australia.scanning@datalogic.com

France and Benelux

Datalogic Scanning SAS
Telephone: [33].01.64.86.71.00
france.scanning@datalogic.com

Germany

Datalogic Scanning GmbH
Telephone: 49 (0) 61 51/93 58-0
germany.scanning@datalogic.com

India

Datalogic Scanning India
Telephone: 91- 22 - 64504739
india.scanning@datalogic.com

Italy

Datalogic Scanning SpA
Telephone: [39] (0) 39/62903.1
italy.scanning@datalogic.com

Japan

Datalogic Scanning KK
Telephone: 81 (0)3 3491 6761
japan.scanning@datalogic.com

Latin America

Datalogic Scanning, Inc
Telephone: (305) 742-2206
latinamerica.scanning@datalogic.com

Singapore

Datalogic Scanning Singapore PTE LTD
Telephone: (65) 6435-1311
singapore.scanning@datalogic.com

Iberia

Datalogic Scanning SAS Sucursal en
España
Telephone: 34 91 746 28 60
spain.scanning@datalogic.com

United Kingdom

Datalogic Scanning LTD
Telephone: 44 (0) 1582 464900
uk.scanning@datalogic.com



www.scanning.datalogic.com

Datalogic Scanning, Inc.

959 Terry Street
Eugene, OR 97402
USA
Telephone: (541) 683-5700
Fax: (541) 345-7140

