

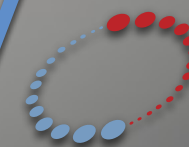

HFM 100 Series

Conforms to International Standards ASTM C518, ISO 8301, and EN 12667

*Thermal Conductivity Meter
for measurement of insulation
and construction materials.*



Thermtest
Thermophysical Instruments

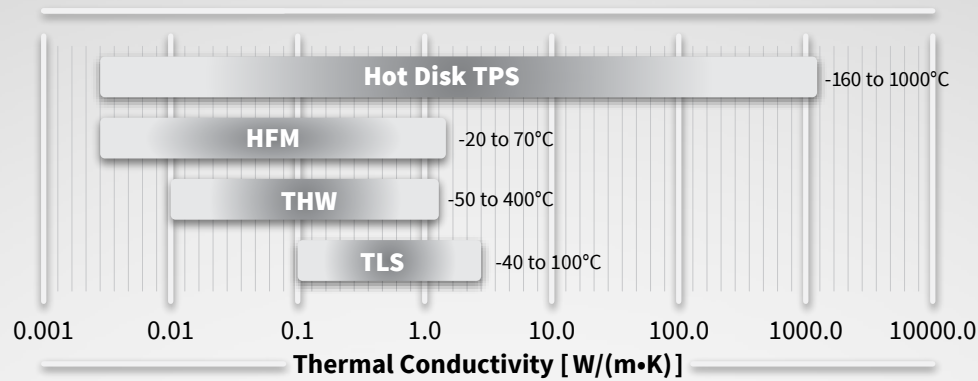

Thermtest has been advancing the measurement of thermal conductivity, thermal diffusivity, and specific heat for more than a decade. With more than 1500 satisfied customers, our unique combination of advanced thermal conductivity instrumentation for the laboratory, portable meters for the field, and accessories, enables us to provide ideal solutions to fit any material testing application and budget. Our proud commitment to being a leader in thermal conductivity has fueled our success through rigorous development and key partnerships, creating a lineup of industry leading testing solutions for the laboratory, field, and production-line.

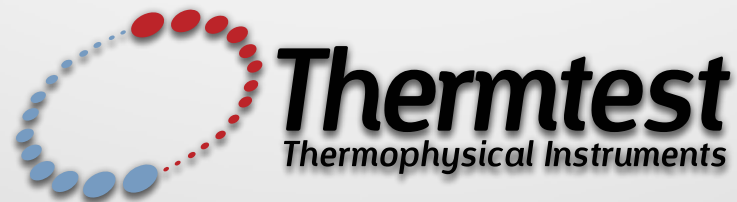

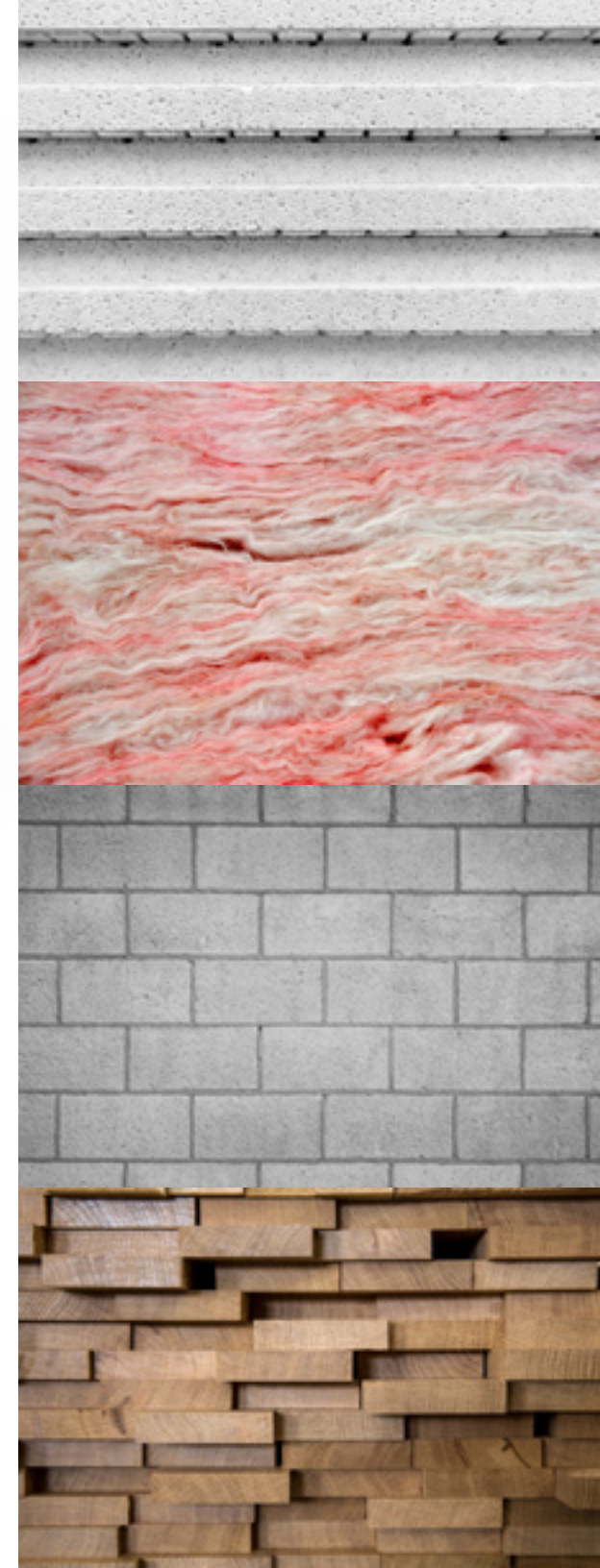

100 SERIES HEAT FLOW METER

The Heat Flow Meter (HFM) 100 is an easy-to-use rapid technique for the measurement of **thermal resistance** and **thermal conductivity** of insulation products, construction materials, packaging, and assemblies. Thermal conductivity is a measure of the ability of a material to conduct heat and can be critical for defining energy efficiency and thermal performance in materials. The Thermtest HFM has been designed and engineered to combine the highest accuracy, repeatability, widest temperature range, and industry leading performance, all at an exceptional value.

HFM 100 SERIES FEATURES

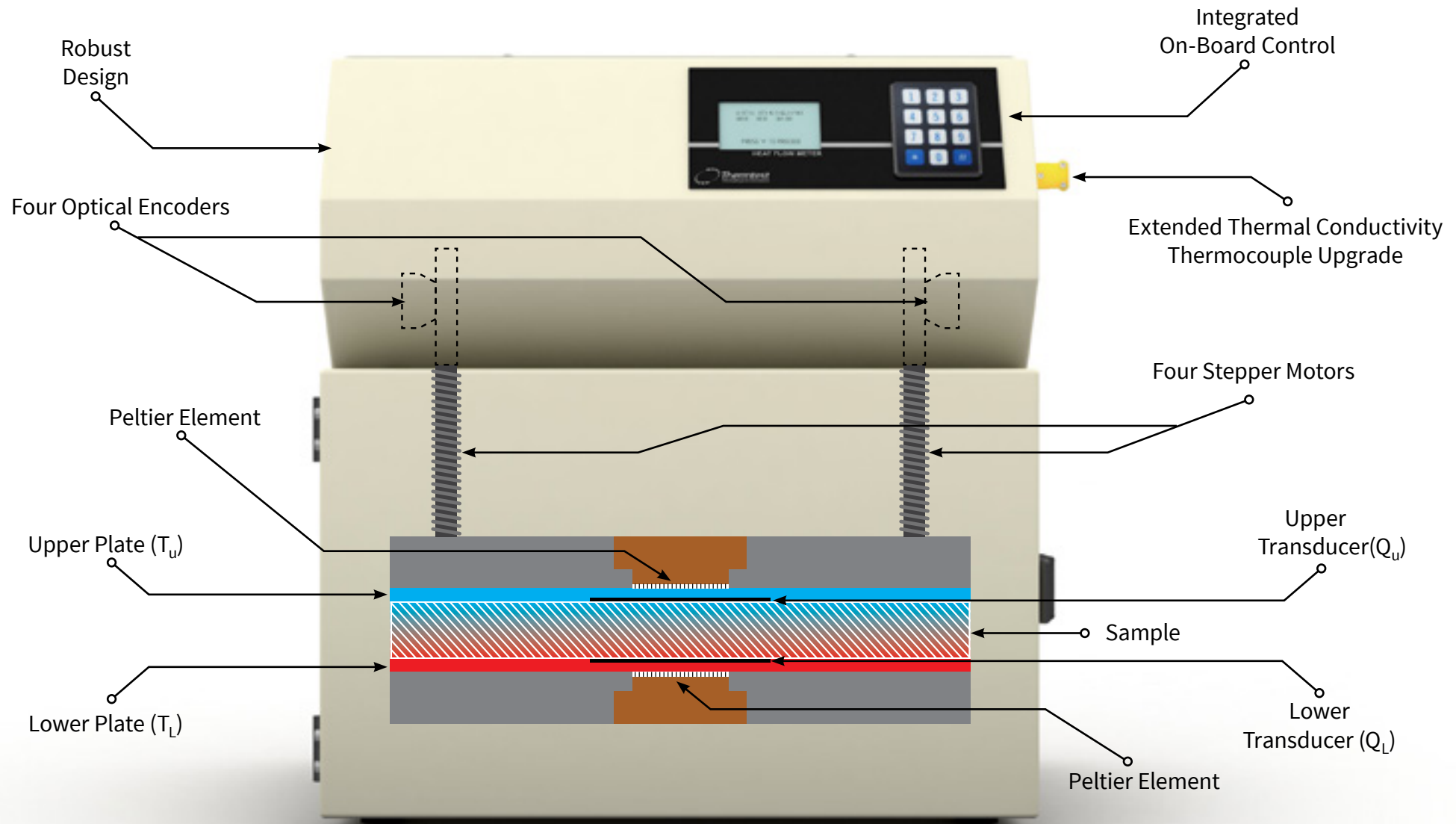

FEATURED HEAT FLOW METER CAPABILITIES

The cost effective HFM 100 instrument is an excellent choice when making steady-state thermal conductivity measurements of specimens such as insulation products and construction materials. Thermtest has rigorously engineered the heat flow meter (HFM) to meet the requirements of international standards including ASTM C518, ISO 8301, and EN 12667. Operating the HFM is straightforward — a sample is positioned between two heating - cooling plates, and the upper plate, powered by stepper motors positioned in each corner, lowers to contact the top of the sample. Plate contact with the test specimen is controlled by a standard applied pressure, or by a user defined specimen thickness. Stepper motors are controlled by individual optical encoders for measurement of sample thickness (**L**), to the nearest **0.1 mm** (0.004 in). Integrated logic between stepper motors allows the upper plate to sense and adjust for specimens with surface variations, optimizing plate - specimen contact for measurements. One heat flux sensor is integrated into each plate, and is used to monitor heat flux (**Q/A**), generated due to the difference in temperature (**ΔT**) between the top and bottom plate at regular intervals, until steady-state heat flux is observed. The composite heat flux is then used to measure thermal resistance (**R**) and calculate thermal conductivity (**λ**) according to Fourier's Law.

$$\lambda = \frac{Q}{A} \frac{L}{\Delta T}$$

UNITS

W/m•K or BTU/(hr•ft•°F)

$$R = \frac{1}{\lambda} L$$

UNITS

m²•K/W or hr•ft²•°F/BTU

- **Two flux sensors for accurate measurement of thermal resistance and thermal conductivity**
- **Peltier heating / cooling plates for rapid control of temperature**
- **Thickness is measured to an accuracy of 0.1 mm (0.004 in) with the use of four digital optical encoders**
- **Front panel operation allows full control of all HFM functions, or use the intuitive HFM Software for basic and additional functions, such as printing and exporting**
- **Plate clamping can be automated or set to a user defined thickness — ideal for compressible materials**
- **Follows international standards: ASTM C518, ISO 8301, and EN 12667**

HFM 100 SPECIFICATIONS

Following international standards, the HFM 100 is designed for testing both homogeneous and heterogeneous materials. The HFM 100 sample size allows for representative testing of materials typically found in insulation and construction industries.

Materials	Insulation, Solids, and Textiles
Type of Sensors	Flux Sensors (x 2)
Applications	General Testing
Direction	Through-Thickness
Thermal Conductivity Range	0.005 to 0.5 W/m•K (0.035 to 3.5 BTU/(hr•ft•°F))
High Thermal Conductivity Kit	Up to 2.5 W/m•K (17.3 BTU/(hr•ft•°F))
Measurement Time	30 to 60 min
Reproducibility	Typically better than 1%
Accuracy	Typically better than 3%
Plate Temperature Range*	-20 to 70°C (-4 to 158°F)
Maximum Sample Size	Up to 300 x 300 x 100 mm (12 x 12 x 4 in)
Standard	ASTM C518, ISO 8301, and EN 12667

Method is continually improved; specifications are subject to change without prior notice.

**Requires chilled circulator.*

TRUSTED ACCURACY AT AN AFFORDABLE PRICE

HFM 100 HIGHLIGHTS

ACCURATE MEASUREMENTS



HEAT FLUX SENSORS

TEMPERATURE CONTROL

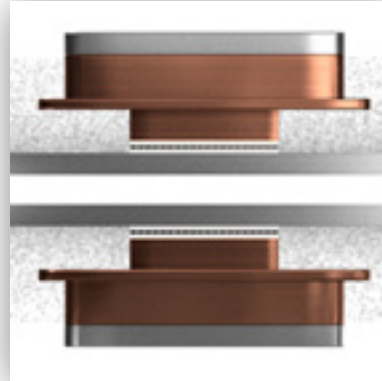

RESOLUTION <math>< 0.1^{\circ}\text{C}</math> (

THICKNESS MEASUREMENT

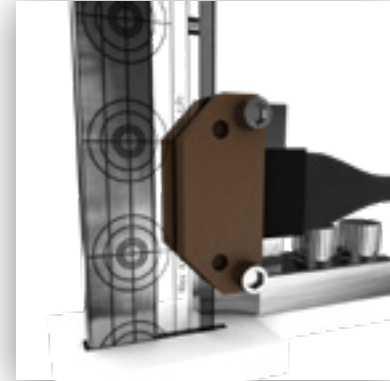

ACCURACY <math>< 0.1\text{ mm}</math> (

VERSATILE OPERATION

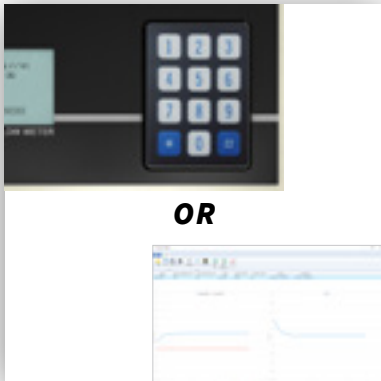

STAND-ALONE OR SOFTWARE

CLAMPING CONTROL



AUTOMATED OR MANUAL

REFERENCE MATERIALS



CERTIFIED OR CUSTOM

MEASUREMENT OF HEAT FLUX

A heat flux sensor is a thermopile sensor, consisting of thermocouple junctions arranged uniformly across the sensor surface. Each individual junction generates an electrical voltage, proportional to the difference in temperature across the hot and cold junctions of the thermocouple. For accurate measurements of heat flux, one sensor is integrated into the surface of each testing plate of the HFM. This intimate contact reduces the level of calibration required, resulting in improved test results.

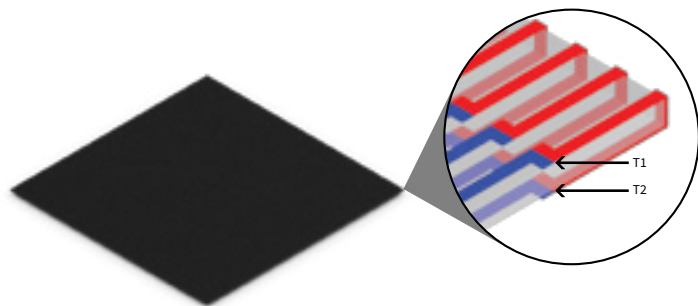

TEMPERATURE CONTROL

Thermoelectric Peltier elements are used to heat and cool the HFM testing plates. A thermoelectric element is a solid-state active heat pump which transfers heat from one side of the device to the other, with consumption of electrical energy, depending on the direction of the current. This flexibility allows the user to easily change heating and cooling direction, to best match their testing application, at a temperature resolution of $< 0.1^{\circ}\text{C}$ (0.18°F). Each thermoelectric module is matched with a thermocouple and smart temperature control to optimize the speed and accuracy of the plate temperatures.

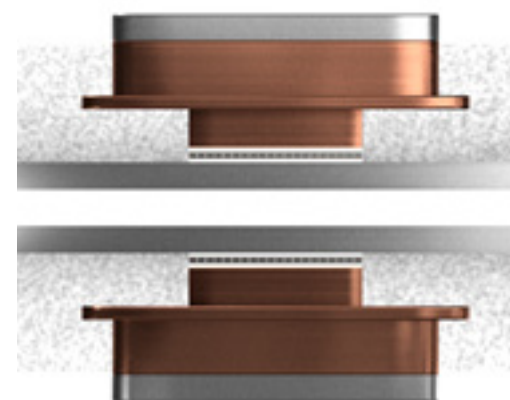

THICKNESS MEASUREMENT

Accurate sample thickness is optimal for determining thermal resistance of a material with the measurement of thermal conductivity. The HFM 100 system features the advantage of either an automatic determination of sample thickness, for rigid materials, or a user defined sample thickness, for compressible materials. Sample thickness is measured using digital optical encoder technology. Four encoders are positioned at each corner of the top sample plate. Multi-position encoder placement ensures the most accurate ($< 0.1 \text{ mm} / 0.004 \text{ in}$) measurement of sample thickness, and in the end, thermal resistance for materials being measured.

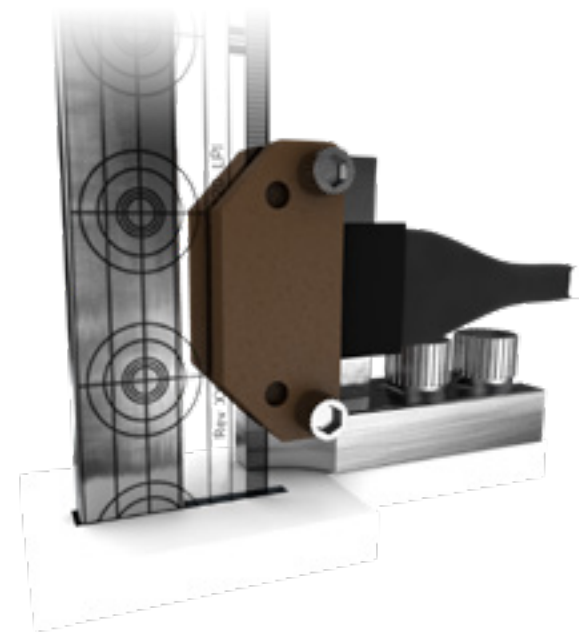

VERSATILE OPERATION

The HFM 100 offers users two versatile and convenient methods of operation – run your measurements independently using the integrated front control panel, or by using the intuitive Windows based HFM software included with each system. The simple to use software offers additional features over the front panel operation, including unlimited steps of temperature automation when testing, and additional functions like saving, exporting, and printing measurement results. With front panel control, users can automate up to five steps of temperature when making measurements, or unlimited steps with the HFM software. HFM results are conveniently available in both SI and Imperial Units of measure.

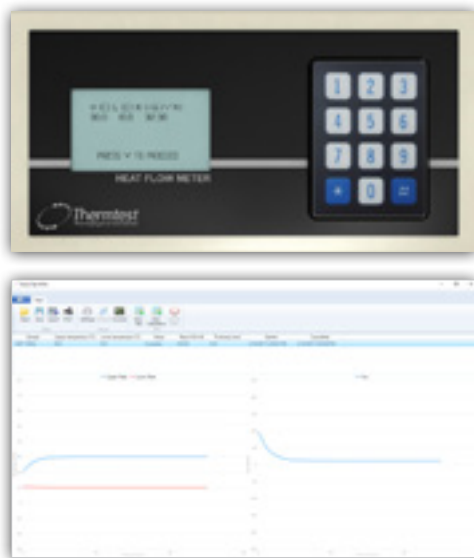



CLAMPING CONTROL

For rigid materials, plates automatically clamp together for optimum contact between sample and heat flux sensors. For compressible materials, the desired height of the sample may be entered manually and the plate will automatically stop at the entered sample height.

REFERENCE MATERIALS

Every HFM 100 system comes complete with one Standard Reference Material (SRM) of your choosing, available from the National Institute of Standards and Technology (NIST). SRM 1450d - Fibrous Glass-Board is certified for thermal conductivity from 6.85 to 66.85°C (44.33 to 152.33°F) and is available in a thickness of 25 mm (1 in). SRM 1453 - Expanded Polystyrene Board is certified for thermal conductivity from 7.85 to 39.85°C (46.13 to 103.73°F), and is available in a thickness of 12.5 mm (0.5 in). In addition to NIST Standard Reference Materials, Thermal Transfer Standards (TS) can be developed by Thermtest, for specialized testing applications.



ACCURACY & REPEATABILITY

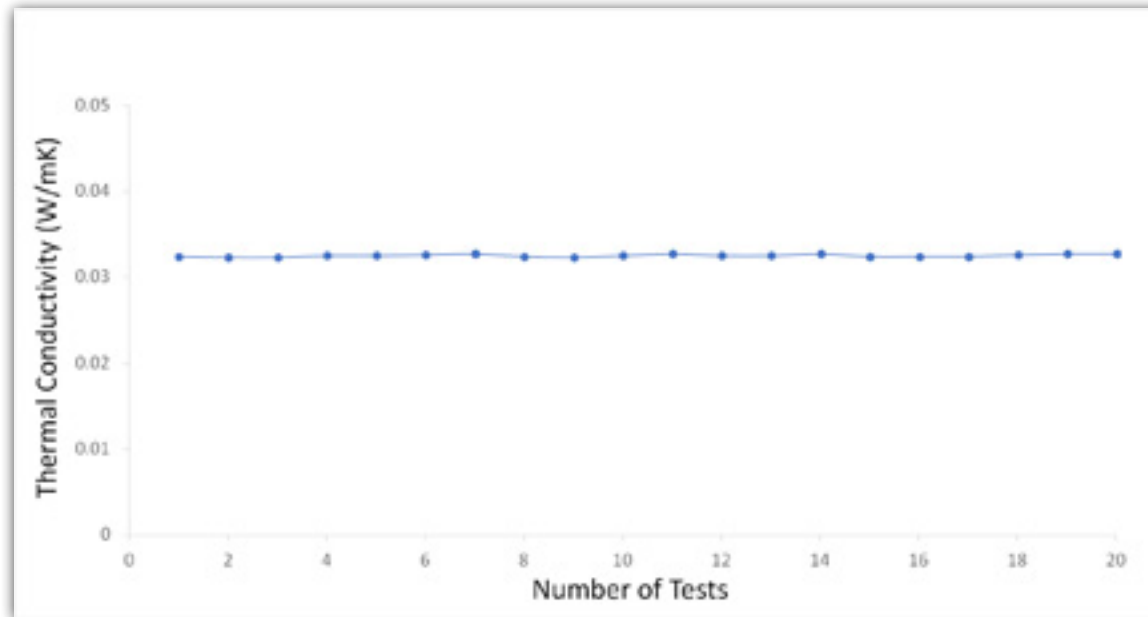

A sample of NIST SRM 1450d was repeatedly tested to confirm the accuracy and repeatability of the HFM 100. Prior to each of the 20 measurements, the NIST 1450d sample was removed, and then placed back within the HFM 100 chamber. The certified thermal conductivity for the NIST piece at **20°C** (68°F) is **0.03239 W/m•K** (0.2246 BTU/(hr•ft•°F)). The average thermal conductivity value received from all 20 tests was **0.0325 W/m•K** (0.2253 BTU/(hr•ft•°F)). All tests had a repeatability within **0.5%**, and an accuracy within **1%** of the certified value.

SAMPLE MEASUREMENT

THE SAMPLE

The sample should be between 150 mm and 300 mm square (6 in to 12 in square), and have parallel surfaces. Sample height is automatically measured by the HFM 100; however for compressible materials, desired sample thickness can be manually entered for predetermined testing thickness.



1 min.

INSERT SAMPLE

Place the sample between the HFM 100's parallel testing plates. For smaller samples or samples of differing shapes from the testing chamber, place the sample within the center of the lower plate, positioned directly over the heat flux sensor.



1 min.



EFFICIENCY WITH EASE

CLOSE PLATES



The top plate automatically lowers for rigid samples or to a predetermined thickness for compressible samples. For added accuracy when testing rigid samples, the top plate makes a short confirming movement for optimum contact and measurement of thickness. Additionally, this short movement will also compensate for any issue with sample flatness.



1 min.

RUN EXPERIMENT



A single mean temperature or steps of temperature may be selected for an automated testing routine. Testing can be performed in either quality control or high accuracy (30 to 60 min) modes for test times which best fit your application. Once testing is complete, results can be saved, printed, or exported to Microsoft Excel for further processing.



30-60 min.

HFM 100 APPLICATIONS

INSULATION VS. TEMPERATURE

The Thermtest HFM 100 is capable of testing materials over a temperature range of **-20 to 70°C** (-4 to 158°F). NIST 1450d, Fibrous Glass Board, is a certified Standard Reference Material from the National Institute of Standards and Technology. Measured results are within **3%** of the certified values.

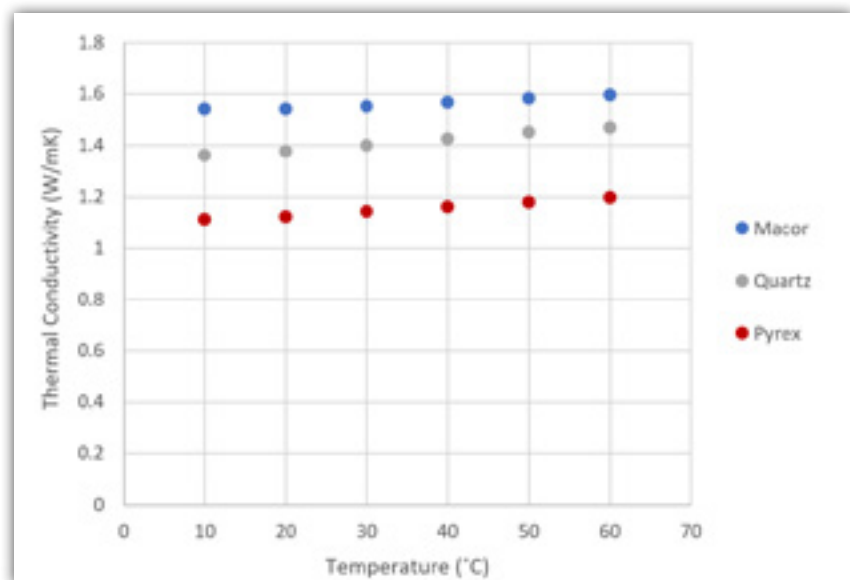
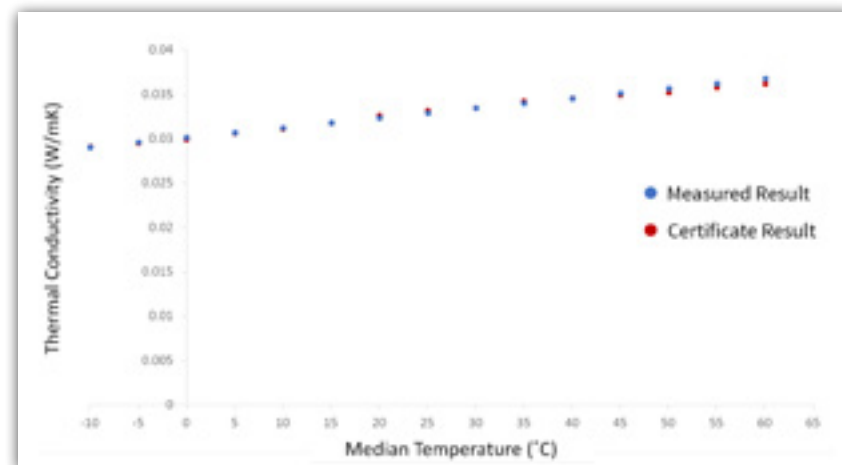

HIGH THERMAL CONDUCTIVITY KIT

With the added High Thermal Conductivity Kit, the HFM-100 is able to accurately, and efficiently measure higher thermal conductivity materials, such as glass and ceramics. For such applications, an external thermocouple kit is used in combination with the sample being tested. Macor, Quartz, and Pyrex were tested in the HFM from 10°C to 60°C (50°F to 140°F). All measured values are within the stated accuracy of the system, **+/- 5%**.

BATTING INSULATION



When testing compressible materials, such as batting insulation, slight changes to the density of a material, due to compressive forces, may alter thermal conductivity. Both a fiberglass and a stone wool batting insulation were tested with the HFM. A thermal conductivity of **0.0430 W/m•K** (0.2981 BTU/(hr•ft•°F)) was the result of the fiberglass testing, where **0.0364 W/m•K** (0.2524 BTU/(hr•ft•°F)) was the result of the stone wool insulation test. These values were within **3%** of the stated manufacturers thermal conductivity.

AEROGEL BLANKETS

Aerogel has one of the lowest thermal conductivities known to solids. An aerogel blanket of choice was selected to test by the Heat Flow Meter. Results concluded a thermal conductivity of **0.024 W/m•K** (0.1664 BTU/(hr•ft•°F)), which is within **3%** to the manufacturers specification.



WOOD

As wood is rigid, the HFM can be set to automatically adjust to the height of the sample. Testing of this softwood produced a thermal conductivity reading of **0.12 W/m•K** (0.8320 BTU/(hr•ft•°F)), an exact match to the literature values for softwoods.

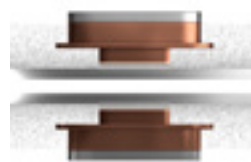

HFM



TPS



THW



TLS

Methods Comparison

Accuracy

± 3%

± 5%

± 5%

± 5%

Measured Property

Thermal Resistance, Thermal Conductivity¹

Thermal Conductivity, Thermal Diffusivity, Specific Heat¹

Thermal Conductivity, Thermal Diffusivity, Specific Heat¹

Thermal Conductivity, Thermal Resistivity¹

Temperature Range

-20 to 70°C

-160 to 1000°C

-50 to 400°C

-40 to 100°C

Materials

Solids – Insulation

Solids, Liquids, Pastes, & Powders

Liquids and Pastes

Soils, Rocks, & Plastics

Calibration

Single – Offset

None – Absolute Measurement

Single – Offset

Multiple – Offset

Contact Resistance

Removed Through Calibration

Removed After Measurement

N/A

Contact Paste

Penetration Depth

Entire Sample

Up to 180 mm

< 1 mm

< 50 mm

Heterogenous Samples

< 20 mm scale

< 10 mm scale

< 1 mm scale

< 10 mm scale

Theory Scientifically Reviewed

Several Published Papers

Several Published Papers

Several Published Papers

Several Published Papers

Specifications sourced from user manuals and available literature.

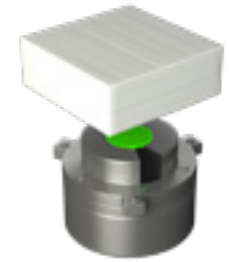
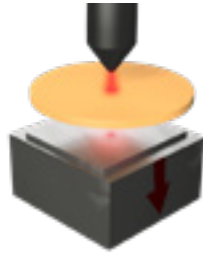

Methods Comparison

LFA

GHP

GHFM

MTPS

Accuracy

± 5 to 7%

± 2%

± 5%

± 5 to 15%

Measured Property

Thermal Diffusivity, Specific Heat¹, Thermal Conductivity¹

Thermal Resistance, Thermal Conductivity¹

Thermal Resistance, Thermal Conductivity¹

Thermal Effusivity, Thermal Conductivity¹

Temperature Range

-253 to 2800°C

-160 to 600°C

-20 to 300°C

-50 to 200°C

Materials

Solids

Solids – Insulation

Solids

Solids, Liquids, & Paste

Calibration

None – Absolute Measurement

None – Absolute Measurement

Single – Offset

Multiple – Secondary

Contact Resistance

Graphite Spray

Contact Paste

Contact Paste

Water & Contact Paste

Penetration Depth

Entire Sample

Entire Sample

Entire Sample

0.1 to 3 mm

Heterogenous Samples

< 0.1 mm scale

< 20 mm scale

< 5 mm scale

< 0.05 mm scale

Theory Scientifically Reviewed

Several Published Papers

Several Published Papers

Several Published Papers

One Published Paper

¹ *Italicized property delineates calculated properties.*

www.thermtest.com