

APPLICATIONS

Les arrêts de bus
Lotissements
Pistes cyclables
Jardins
Parkings

FONCTIONNEMENT

Détecteur
crépusculaire
Intensité
programmable
LED haute intensité

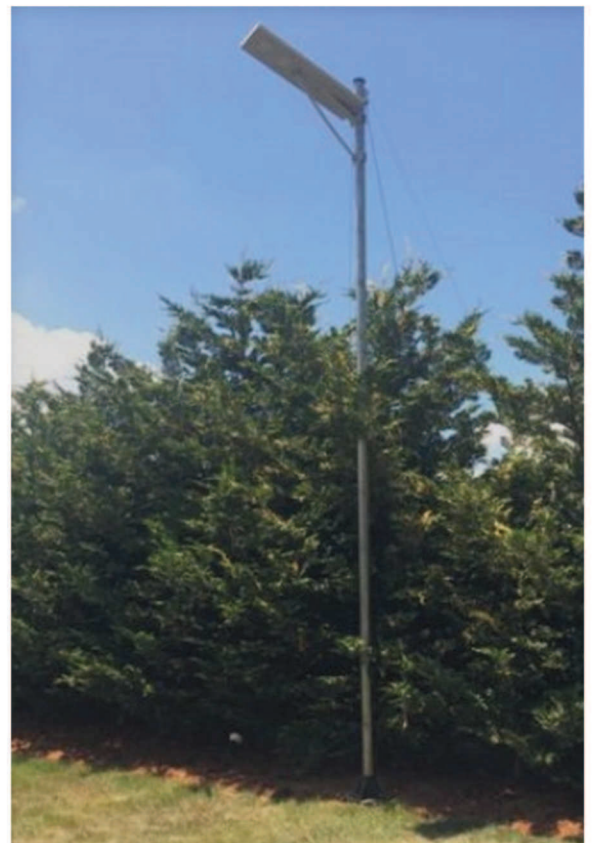
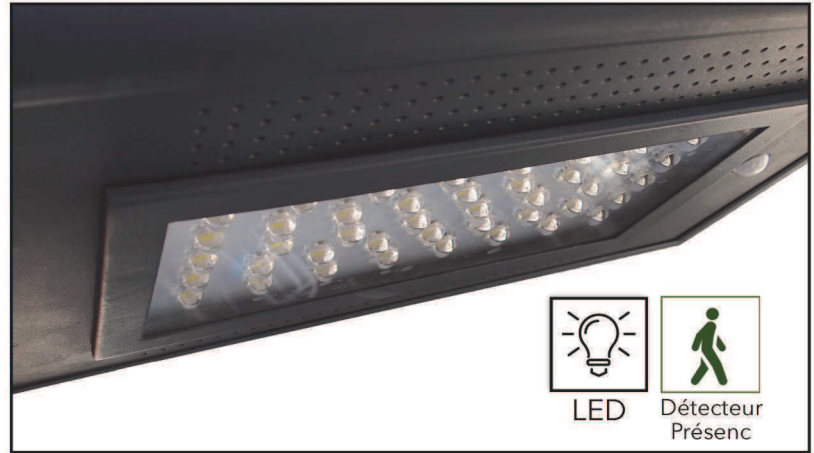

- Installation facile
- Fonctionnalités multiples
- Adaptable au mur ou au poteau

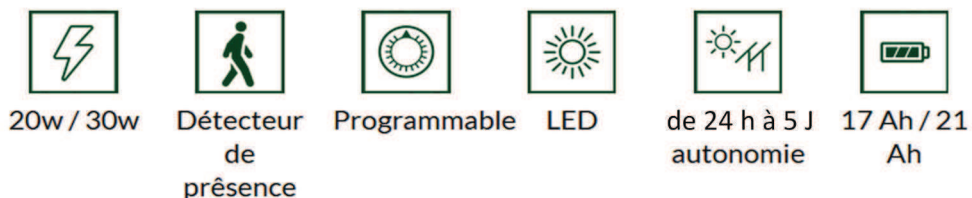

FICHE CARACTERISTIQUES DE LA GAMME - COMPACT- 20/30W

ECLAIRAGE

| | |
|-------------------------|-----------------------------|
| Puissance LED | 20w/30w - détection 30/100% |
| Applications | Eclairage lotissement/rue |
| Température d'éclairage | 5700K (Blanche) |
| Intensité lumineuse | 2200 Lm max / 3200 Lm max |
| Rendement lumineux | 110 lm/w |
| Efficacité de l'optique | 85% |
| Durée de vie | > 50.000 heures |
| Hauteur d'éclairage | 4 m à 7 mètres |
| Indice de protection | IP65 / IK09 |

PANNEAU SOLAIRE HORIZONTAL

| | |
|---------------|--------------------------|
| Puissance | 50 Wp / 65Wp |
| Tension crête | 19,6 V |
| Durée de vie | 80% de puissance >25 ans |
| Température | -25°C à +65°C |
| Technologie | Polycristallin |

BATTERIE

| | |
|--------------|------------------------------|
| Technologie | Batterie NiMH |
| Tension | 12 V |
| Capacité | 17 Ah / 204 W - 26 Ah / 312W |
| Température | -20°C à +70°C |
| Autonomie | de 2 jusqu'à 5 jours |
| Durée de vie | 8/10 ans |
| Garantie | 3 ans |

ELECTRONIQUE

| | |
|--------------------------|------------|
| Tension d'entrée | 8/32 V DC |
| Courant de charge | 8A |
| Humidité / IP | 95% / IP68 |
| Surcharge et polarité | Oui |
| Protection court-circuit | Oui |
| Protections de polarité | Oui |

STUCTURE DU MATERIEL

| | |
|---------------------|-------------------------|
| Type de matériel | Acier galvanisé à chaud |
| Dimensions 20W | 960 x 340 x 45mm |
| Dimensions 30W | 1210 x 340 x 45 mm |
| Humidité relative | 90% |
| Diamètre sup du mât | 60/90 mm |

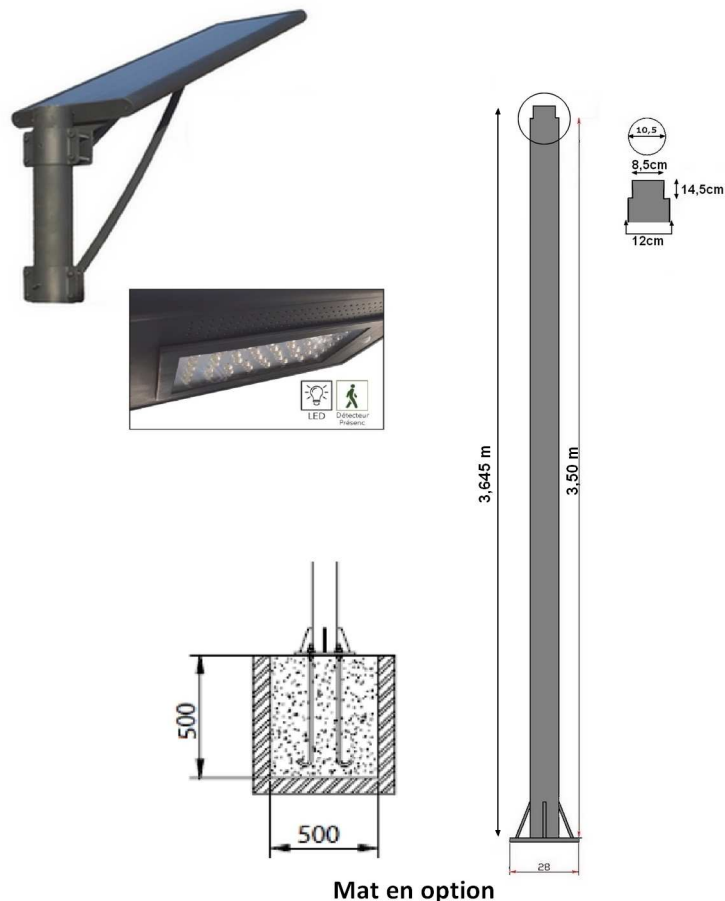

ETUDE SUR UNE MOYENNE DE 20 LUX

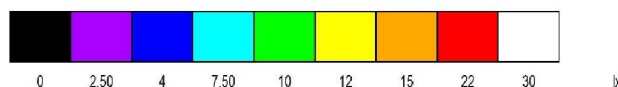
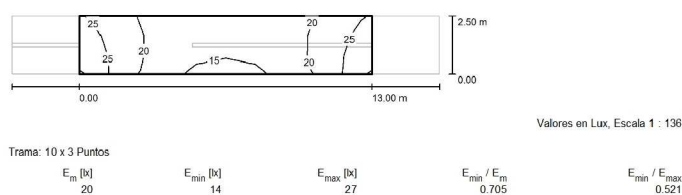

Gamme compact - étude d'éclairage lumineux

covimed
solar
COMPACT-20
illumination frontale 5m

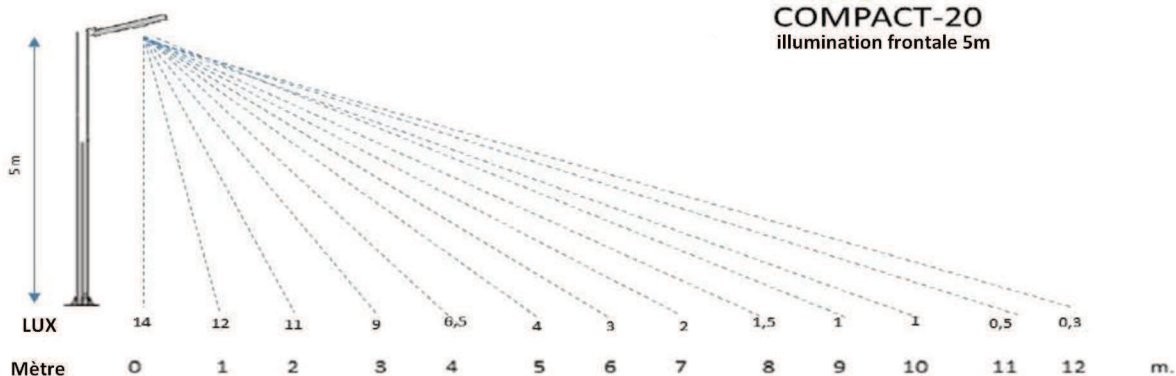

covimed
solar
COMPACT-20
illumination latérale 5m

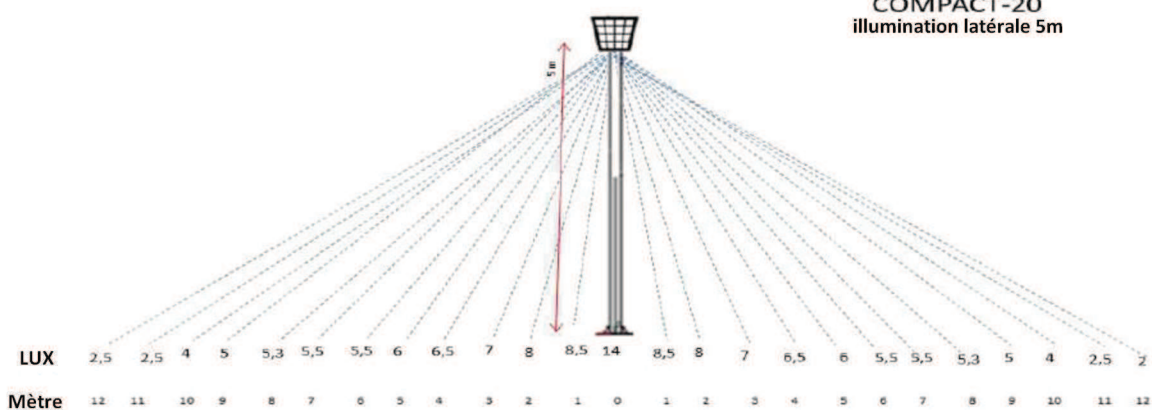

covimed
solar
COMPACT-30
illumination frontale 5m

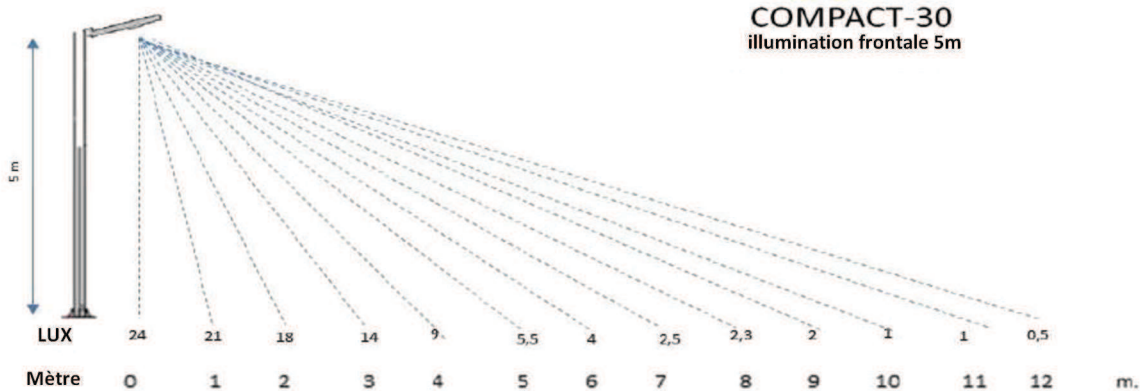

covimed
solar
COMPACT-30
illumination latérale 5m

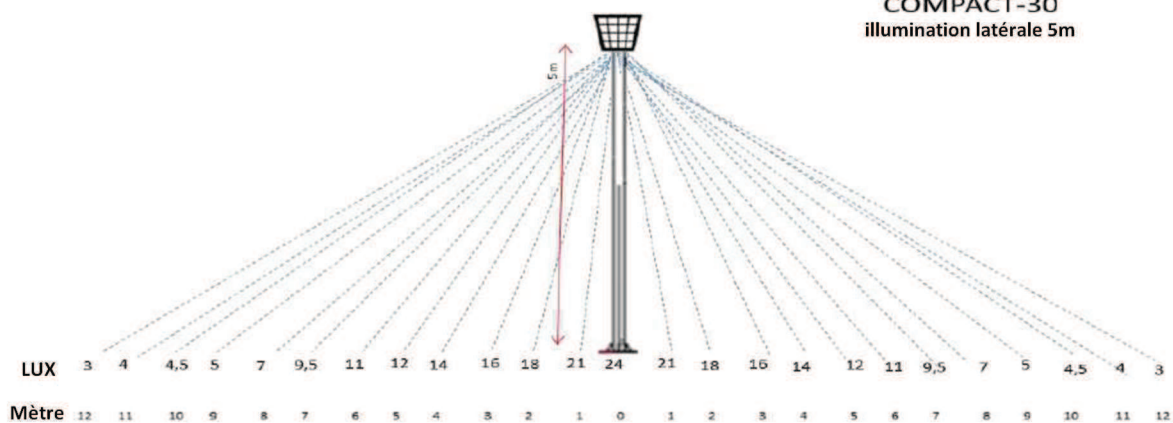

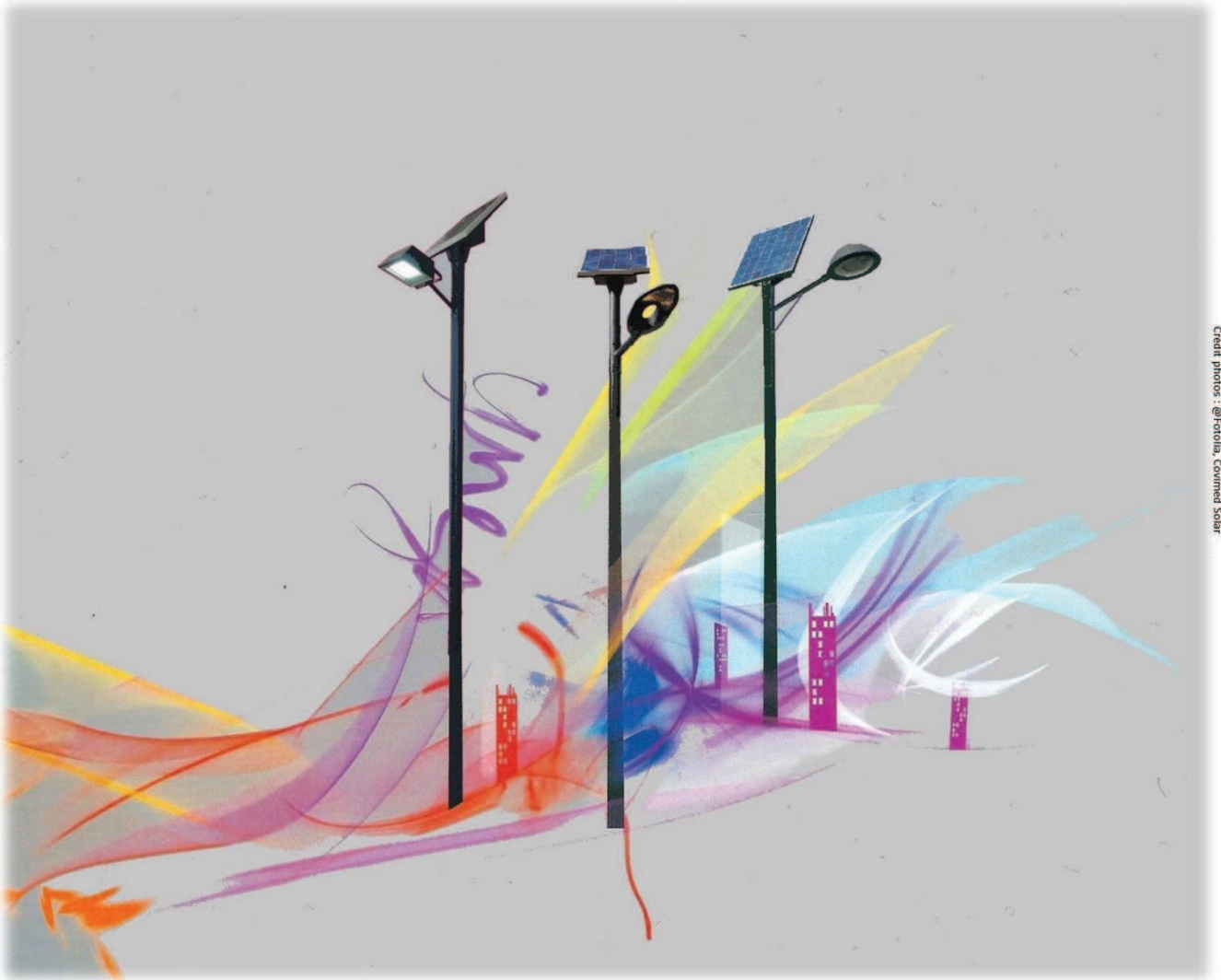

Credit photos : @Fotolia, Covimed Solar



Site web



Site web

COVIMED SOLAIRE France – 11 bis Rue des Fontaines – 31410 LAVERNOSE LACASSE
Tél : 06 79 14 66 28 – Email: contact@covimed.fr – www.covimed.fr
RCS TOULOUSE : 518 982 640 - Siret : 518 982 640 00020

COVIMED SOLAR - Poligono Industrial Finca Lacy - C/Rebajadoras, parcela K2
03600 ELDA (Alicante) - Tel/Fax 96 698 15 04 - E-mail : covimed@covimed.net – www.covimed.net
Sociedad Limitada R.M.A. Tomo 2.514, Folio 83, Hoja A- 69054, sección 8 C.I.F. B-53635652