



Stereo Microscopes
The World Leading Stereo Microscope Range

Stereo Microscopes



The Next Revolution in Microscopy

A Giant Step Forward in Stereo Microscopy

Nikon offers a broad range of stereo microscopes and accessories, including a research stereo microscope system with the world's highest zoom ratio, superb resolution and bright fluorescence imaging. Also features other versatile parallel-optics type models suitable for various applications and Greenough-type models that are user-friendly and affordable.

	SMZ25	SMZ18	SMZ1270/ 1270i	SMZ800N
Optical system	Parallel-optics type			
				
Zoom ratio	25:1	18:1	12.7:1	8:1
Zooming range	0.63-15.75x	0.75-13.5x	0.63-8x	1-8x
Total magnification*1 (with standard set*2)	3.15-945x (6.3-157.5X)	3.75-810x (7.5-135X)	3.15-480x (6.3-80X)	5-480x (10-80X)
Working distance*3	60mm	60mm	70mm	78mm
Image capture	○	○	○	○
System expandability	○	○	○	○
Embedded use	—	—	○	○

Index

Stereo Microscopes

- SMZ25, SMZ18 4
- SMZ1270/1270i, SMZ800N 8
- SMZ745/745T 12
- SMZ445/460, SMZ-2 13

Accessories (for SMZ25, SMZ18)

- Base Unit, Focus Unit, Stand/Focus Mount 14
- Objectives, Tubes, Nosepiece/Focus Mount Adapter, Stage 15
- Controller, Darkfield Observation Accessory, Polarizing Observation Accessory, Epi-fluorescence Set 16
- Fiber Illuminator Set, Coaxial Illuminator, Ring LED Illuminator 17

Accessories (for SMZ1270/1270i, SMZ800N, SMZ745/745T, SMZ445/460, SMZ-2)

- Objectives, Auxiliary Objectives 18
- Nosepieces, Tubes, Eye-level Riser, Intermediate Tubes 19
- Stages, Observation Attachments 20
- Illumination Systems 21
- Stands 22
- Universal Table Stands/Focusing Mounts 23

Specifications/System Diagrams

- System Diagrams (SMZ25/18) 24
- Specifications (SMZ25/18) 25
- System Diagrams (SMZ1270/1270i/800N, SMZ745/745T) 26
- Specifications 28

SMZ745/SMZ745T	SMZ445/ SMZ460	SMZ-2	
Greenough type			Optical system
			
7.5:1	4.4:1 / 4.3:1	5:1	Zoom ratio
0.67-5x	0.8-3.5x / 0.7-3x	0.8-4x	Zooming range
3.35-300x (6.7-50X)	4-70x (8-35X)/ 3.5-60x (7-30X)	4.8-120x (8-40X)	Total magnification*1 (with standard set*2)
115mm	100mm	77.5mm	Working distance*3
○ (SMZ745T)	—	—	Image capture
—	—	—	System expandability
○	○	○	Embedded use

*1 Depends on the combination of eyepiece and objective lens

*2 With a 10x eyepiece and a 1x objective

*3 With a 1x magnification without auxiliary objective

Parallel-optics type

Research Stereo Microscope

SMZ25/SMZ18

Evolutionary stereo microscope

Nikon has developed a stereo microscope that features a large zoom ratio of 25:1, high resolution and exceptional fluorescence transmission capability. These models meet the increasing needs for imaging systems that span spatial scales from single cells to whole organisms.

World's widest zoom range and highest resolution for a stereo microscope

- First stereo microscope to offer a 25:1 zoom range (SMZ25)
- Both eye paths boast numerical apertures (NA) of up to 0.156, using the SHR Plan Apo 1x objective and SMZ25

Automation and digital imaging

- Motorized focus and zoom operation (SMZ25)
- Imaging Software NIS-Elements enables the use of multiple imaging, processing and analysis modalities, including z-stack capture, time-lapse imaging and EDF image generation

Bright, high-contrast fluorescent images

- Fly-eye lens ensures uniform brightness over the entire field of view even at the lowest magnifications
- Breakthroughs in optical design mean significantly improved signal to noise ratio and crystal clear fluorescent images

Easy to use

- User-friendly remote control (SMZ25)
- Easy-to-operate slim LED DIA base with OCC illumination
- Wide range of illuminators and accessories that accommodate a variety of observation methods



SMZ25 Motorized zoom model with the highest zoom ratio and resolution in the SMZ series



SMZ18 Manual zoom model providing advanced optical performance and incredibly bright fluorescence at an attractive price

Model	SMZ25	SMZ18
Type	Motorized zoom	Manual zoom
Observation	Brightfield/Darkfield/Fluorescence/Simple polarizing	
Zoom ratio	25:1	18:1
Magnification range	0.63x - 15.75x	0.75x - 13.5x (with 0.75/1/2/3/4/5/6/8/10/12/13.5x click stops)
Maximum magnification	315x ^{*1}	270x ^{*1}
Maximum FOV	ø70 mm ^{*2}	ø59 mm ^{*2}
Maximum NA of	0.312 ^{*3}	0.3 ^{*3}

*1: Using SHR Plan Apo 2x/ C-W10xB *2: Using SHR Plan Apo 0.5x/ C-W10xB *3: Using SHR Plan Apo 2x

Remarkable resolution and the world's widest zoom range

Dynamic zoom ratio of 25:1 SMZ25

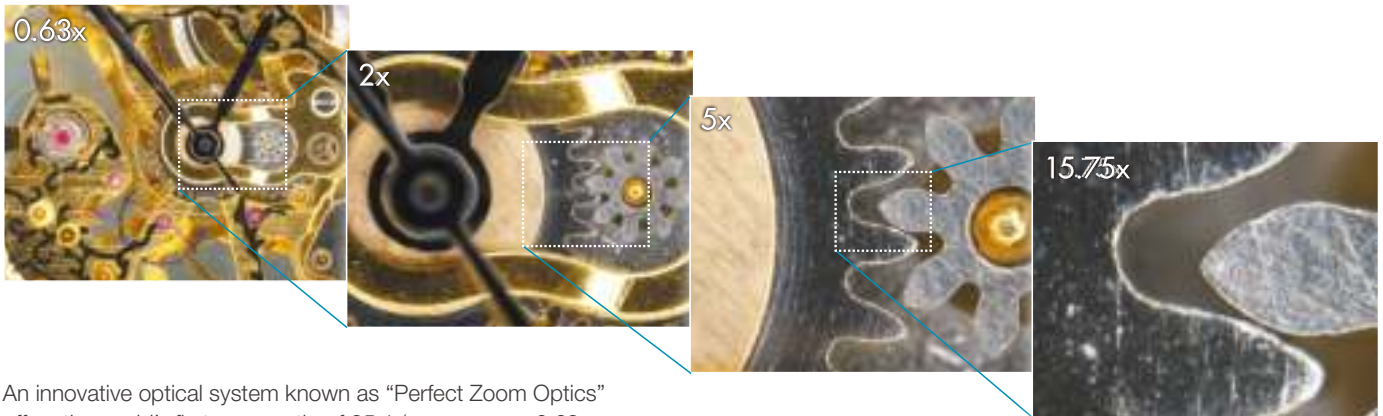

An innovative optical system known as "Perfect Zoom Optics" offers the world's first zoom ratio of 25:1 (zoom range: 0.63x - 15.75x). The SMZ25 can seamlessly capture the entire dish while simultaneously delivering microscopic details.

Auto Link Zoom (ALZ) supports seamless viewing at different scales SMZ25

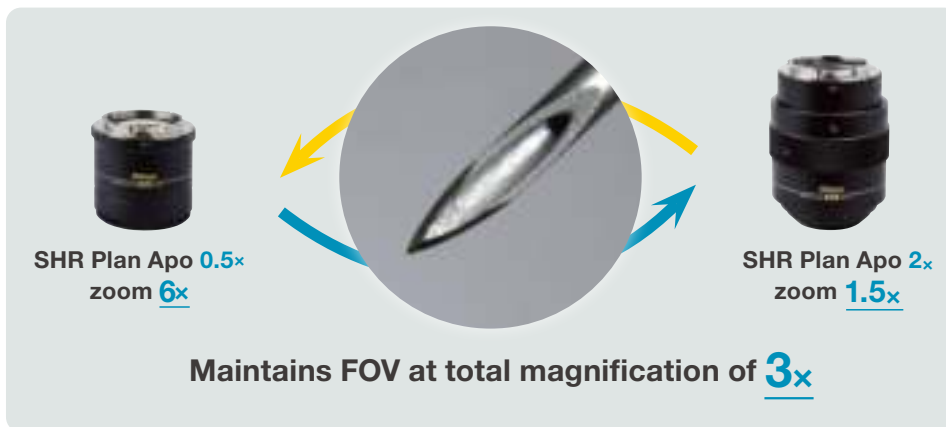

ALZ automatically adjusts the zoom factor to maintain the same field of view when switching objective lenses. This function enables seamless switching between whole organism imaging at low magnifications and detailed imaging at high magnifications.

Superior resolution never before seen on a stereo microscope SMZ25 SMZ18

Newly developed SHR (Super High Resolution) Plan Apo series objectives offers a resolution of 1100LP/mm (observed value, using SHR Plan Apo 2x at maximum zoom). The 0.5x, 1x, or 1.6x lower magnification objectives deliver a bright field of view and brilliant images with true-to-life colors. All the SHR lenses are parfocal with each other. When used together with the accessory nosepiece, refocusing after a lens change will not be needed.



Comparison of resolution and color aberration by resolution chart

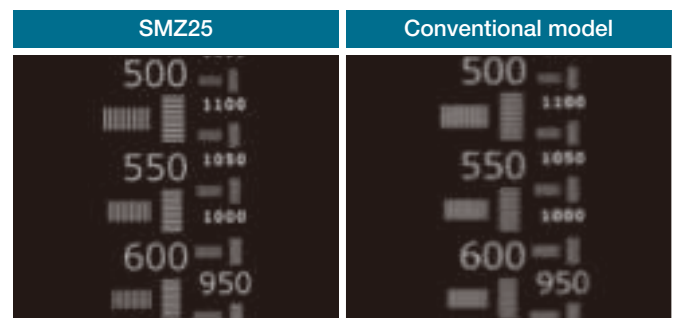

Parallel-optics type

Bright, high-contrast fluorescent images SMZ25 SMZ18

Enhanced brightness and uniform illumination in a low magnification range

The SMZ25 series is the first stereo microscope in the world to use a fly-eye lens on an epi-fluorescence attachment. This ensures bright, uniform illumination even at low magnifications across a large field of view.

Improved S/N ratio and crystal clear fluorescent images thanks to an improved optical system

Nikon has succeeded in improving the signal and reducing noise in fluorescent images by using a short-wavelength, high-transmission Fluor lens. This enables observations of cell division and samples with weak fluorescence, both of which are difficult to observe and record images using conventional stereo microscopes.

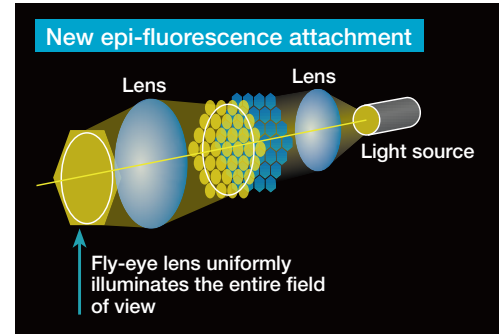

Sample images

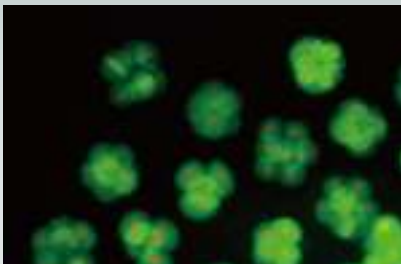

Fertilized mouse egg

Image courtesy of Kazuo Yamagata, Ph.D., Center for Genetic Analysis of Biological Responses, Research Institute for Microbial Diseases, Osaka University

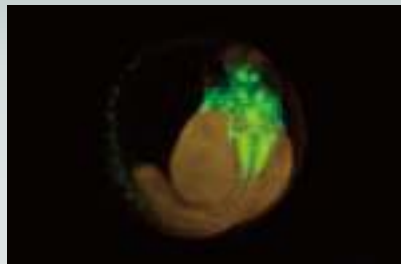

2 days old Transgenic Zebrafish embryo, Tg (isl1-GFP)

(using SHR Plan Apo 1x at zoom magnification of 6x with SMZ25)
Image courtesy of Hisaya Kakinuma, Ph.D., Laboratory for Developmental Gene Regulation, Developmental Brain Science Group, RIKEN Brain Science Institute

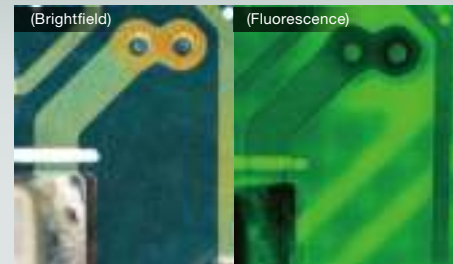

Board

Automation and digital imaging SMZ25 SMZ18

A wide range of digital imaging capabilities with the Digital Sight series and NIS-Elements imaging software

Easily obtain the information required, such as Z drive position, zoom factor, objective lens, filter cube and LED DIA brightness, by using the Digital Sight series and NIS-Elements together with the microscope.



Detected observation condition/available control	⊙ : Detection and control of observation condition possible ○ : Detection of observation condition possible	
	SMZ25 + NIS-Elements	SMZ18 + NIS-Elements
	<ul style="list-style-type: none"> Motorized focus unit Motorized epi-fluorescence set (control box A) 	<ul style="list-style-type: none"> Manual focus unit Manual epi-fluorescence set (relay box and control box B)
Zoom magnification	⊙	○
Focusing	⊙	—
Objective (with nosepiece)	○	○
Diascopic LED illumination stand (ON/OFF, light intensity control)	⊙	⊙
Fluorescence illuminator (light intensity control)	⊙	⊙
Filter cube	⊙	○

For other combinations, please confirm with Nikon.

Note: With NIS-Elements L and F, functions above are not available. Use NIS-Elements D/Br/Ar.

Improved observation efficiency

Easy-to-use OCC illumination

SMZ25

SMZ18

The LED DIA Base with built-in OCC illuminator generates minimal heat, consumes little power and has a long life. The illuminator also enhances the contrast of uneven surfaces, such as those of film.



The OCC illuminator can be controlled using a slide lever. Thanks to scales on the slide lever, the user can save and reproduce desired illumination levels. In addition, an OCC plate can be inserted into the illumination unit from the front and rear sides, so images with different shadow direction can be observed.

Comparison images (film)



Conventional diascope illumination

OCC illumination

What is OCC illumination?

OCC stands for oblique coherent contrast, a form of oblique lighting method developed by Nikon. Compared to conventional diascope illumination that illuminates directly from below, OCC illumination applies coherent light to samples in a diagonal direction, adding contrast to colorless and transparent sample structures.

User-friendly remote control

SMZ25

The remote control provides easy access to zoom and focus controls and is designed for both right- and left-hand use. The remote control contains an LCD monitor with an adjustable backlight that provides at-a-glance information about zoom factor, objective lens, filter cube and LED DIA brightness.



On-axis imaging for digital images

SMZ25

SMZ18

Easily switch between stereo position (stereoscopic view) and mono position (on-axis view) when using the P2-RNI2 Intelligent Nosepiece by simply moving the objective lens.

Comparison of on-axis image and stereoscopic image



On-axis image

Stereoscopic image

Parallel-optics type

Stereo Microscope

SMZ1270/1270i SMZ800N



Incredible sharpness throughout a wide magnification range

These versatile stereo microscopes provide both excellent optical performance, such as high-magnification, high-zoom ratio and high-resolution images, and advanced operability. The expandability of parallel optics makes these models suitable for a wide range of applications.

Highest-in-class zoom ratio

- Highest-in-class zoom ratio of 12.7:1 (0.63 – 8x) with SMZ1270/1270i
- New WF series objectives optimized for wide viewfield observation at low magnification

High-quality images

- High-level chromatic aberration correction provides sharp images throughout the viewfield.

Easy to get results

- Automatically detects magnification data in combination with the digital camera control unit (SMZ1270i only)
- Nosepiece offers both widened magnification range and on-axis imaging
- Eyepiece tubes with various inclination angles and slim-type stands minimize user fatigue during observation

Expandable with a wide range of accessories

- A wide range of accessories are available, including eyepiece tubes and stands that are equal to superior specification stereo microscope models



SMZ1270

Versatile stereo microscope with the highest-in-class zoom ratio



SMZ1270i

The same as the SMZ1270 but equipped with intelligent functions found in superior models (SMZ1270i with a trinocular tilting tube and nosepiece)



SMZ800N

Affordable model with improved operability and basic performance

Highest-in-class zoom ratio

Wide zoom range

The SMZ1270/1270i offers the highest-in-class zoom ratio of 12.7x (0.63 – 8x). It offers both low-magnification wide viewfield observation of the whole of a 35 mm petri dish* during screening and high-magnification observation of minute cell structures

* with 1x objective at the lowest magnification.



SMZ1270/1270i enables observation of the whole of a 35 mm petri dish.

The SMZ800N comes with a 1 – 8x zoom range, with higher magnification than conventional models and enables high-resolution observation of 640LP/mm (using ED Plan Apo 2x/WF at maximum zoom).

Improved resolution of SMZ800N



SMZ800N

Conventional model

Wide viewfield of SMZ1270/1270i

Ampulex

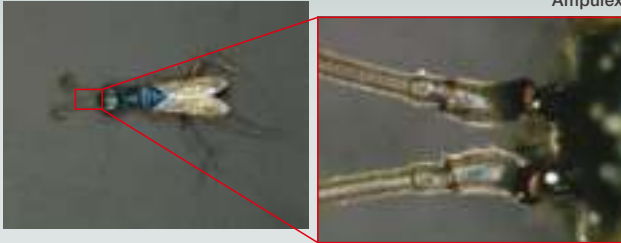

0.63x zoom

8x zoom

Wide field objectives

The WF series objectives offer uniformly bright images even at low magnification and wide viewfield observation with SMZ1270/1270i. In addition, a 0.75x objective is now available, expanding the lineup of low magnification objectives.



High-quality images

Apochromat optics have been adopted for the lenses in the SMZ1270/1270i zoom body and semi-apochromat optics in the SMZ800N to achieve high-level chromatic aberration correction. They provide sharp images without blur or color fringe.



Apochromat optics
(captured with SMZ1270+Plan Apo 1x/WF)

Conventional optics

Easy to get results

Intelligent function for status readout **SMZ1270i**

In combination with the imaging software NIS-Elements, the SMZ1270i can detect zoom magnification data. In addition, with the Intelligent Nosepiece P-RNI2 attached, data related to the objective in use is also detected. Calibration data is automatically altered, following changes of magnification, to display the appropriate scale and measurement results on the images.

Microscope Camera DS-FI3/Digital Sight 10

SMZ1270i + Intelligent Nosepiece

Imaging Software NIS-Elements

- Detection of zoom magnification and objective information
- Calibration auto change

Correct scale is always indicated

Note: With NIS-Elements L and F, functions above are not available. Use NIS-Elements D/Br/Ar.

On-axis observation with the nosepiece

The double nosepiece offers easy on-axis imaging, enabling observation of the bottom of holes, accurate simple measurement and extended depth of focus (EDF) imaging without distortion.

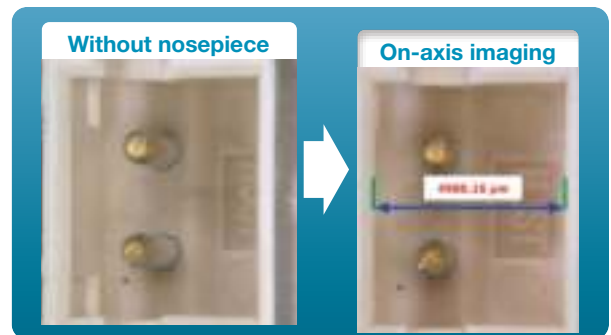
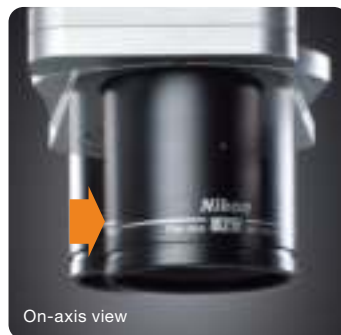

Ergonomic design

Eyepiece tubes with a range of inclination angles are available for comfortable observation. They offer the optimum eyelevel to suit each user. In addition, slim-type plain stands and the LED Diascopic Illumination Stand easily facilitate the presentation and removal of specimens.

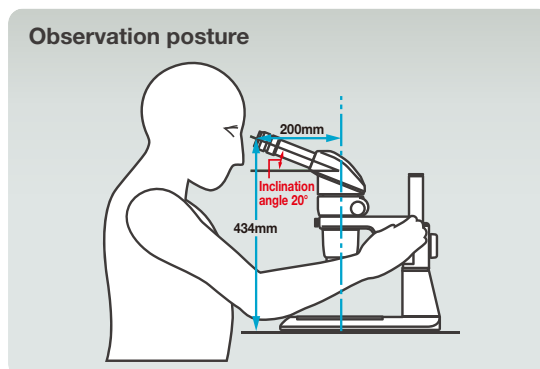

With the LED Diascopic Illumination Stand and Fiber Diascopic Illumination Stand, focus control during observation is possible using the dial in front of the base.

Expandable with a wide range of accessories

In addition to conventional accessories, the level of accessories used with superior models is also available for the SMZ1270/1270i and SMZ800N. These include trinocular tubes and slim-type LED diascope illumination stands. These allow various microscope configurations to suit numerous routine inspections and a range of research and development applications.



Fibers



Semiconductor



Brain of adult drosophila excited with GFP
Image courtesy of Hokto Kazama, Ph.D., Circuit Mechanisms of Sensory Perception, Brain Science Institute, RIKEN

OCC illumination



Diascopic brightfield illumination



With the LED Diascopic Illumination Stand and Fiber Diascopic Illumination Stand, image contrast under OCC illumination can be easily adjusted.

OCC illumination boosts the contrast of transparent sample structures.
Hemicentrotus pulcherrimus in two-cell stage

	SMZ1270	SMZ1270i	SMZ800N
Optical system	Parallel-optics type (zooming type)		
Zoom ratio	12.7 : 1		8 : 1
Zoom range	0.63 – 8x (0.63/1/2/3/4/6/8x stops)		1 – 8x (1/2/3/4/6/8x stops)
Total magnification	3.15 – 480x (depending on eyepiece and objectives) (with coaxial episcopic illuminator: 15 – 540x)		5 – 480x (depending on eyepiece and objectives) (coaxial episcopic illuminator: 22.5 – 540x)
Tubes	Eyepiece inclination: 20° (P-B Binocular Tube) / 0°-30° (P-TERG100 Trinocular Tilting Tube, P-TERG50 Trinocular Tilting Tube), P-T100 Trinocular Tube		
Eyepieces	C-W10xB (F.N. 22), C-W15x (F.N. 16), C-W20x (F.N. 12.5), C-W30x (F.N. 7)		
Objectives	Plan Apo 0.5x/WF, Plan Apo 0.75x/WF, Plan Apo 1x/WF, ED Plan 1.5x/WF, ED Plan 2x/WF		Plan Apo 0.5x/WF, Plan Apo 0.75x/WF, Plan Apo 1x/WF, ED Plan 1.5x/WF, ED Plan 2x/WF, Plan 1x, Achrom 0.5x
Working distance	70 mm (with Plan Apo 1x/WF)		78mm (with Plan 1x)
Weight (approx.)	9.8 kg (with P-B Binocular Tube + P-DSL32 LED Diascopic Illumination Stand)	11.9 kg (with P-TERG100 Trinocular Tilting Tube + P-DSL32 LED Diascopic Illumination Stand)	6.8 kg (with P-B Binocular Tube + C-PSN Plain Stand)

Please refer to the system diagram (P. 26-27) for accessory combinations.

Dimensions

SMZ1270 set

SMZ1270 + P-B Binocular Tube + Plan Apo 1x/WF + P-PS32 Plain Stand

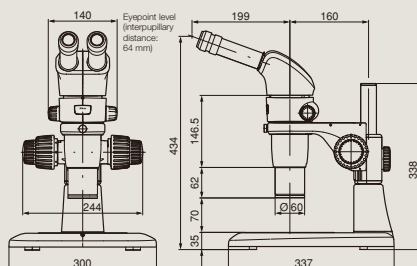

SMZ1270i set

SMZ1270i + P-TERG100 Trinocular Tilting Tube + Plan Apo 1x/WF + Intelligent Nosepiece P-RN12 + P-DSL32 LED Diascopic Illumination Stand

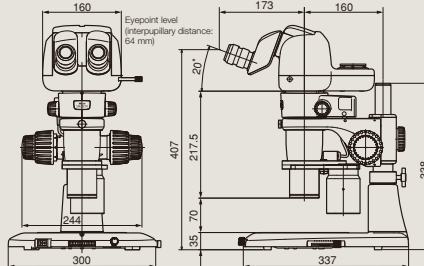

SMZ800N set

SMZ800N + P-B Binocular Tube + C-PSN Plain Stand

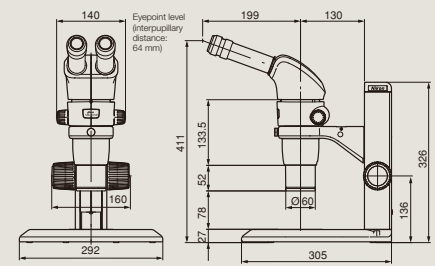

Unit: mm

Greenough Type Stereo Microscope

SMZ745/745T

Superior 7.5x zoom and 115 mm working distance
Trinocular optical head type is also available

- The SMZ745/745T boasts a 7.5x zoom that incorporates the Greenough optical system. The zoom range of 0.67x to 5x provides a broad observation range.
- As well as high zoom ratio and magnification, the SMZ745/745T offers an unrivaled 115 mm working distance.
- The SMZ745T incorporates an optical path switching lever that enables easy switchover between eyepiece and camera. A microscope camera can be attached.



Three "A" design

• Air-tight **SMZ745**

By making joints air-tight, contamination from dust, oil, water and other contaminants is prevented.

Air-tight construction: JIS Degrees of protection provided by enclosures IPX1

• Anti-fungal design **SMZ745** **SMZ745T**

Anti-fungal design developed exclusively by Nikon ensures peace of mind when the microscope is used in environments subject to high heat or humidity.

• Anti-electrostatic **SMZ745** **SMZ745T**

Static electricity built up within the microscope is discharged almost instantly, ensuring higher yields.
Anti-static function: 1000–10V, discharge within 0.2 sec.

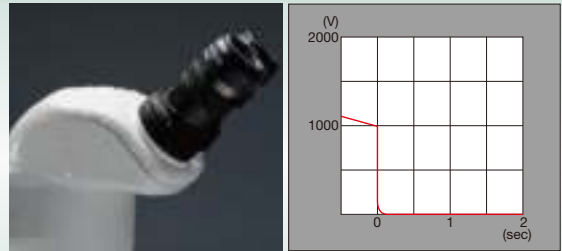

Specifications

	SMZ745	SMZ745T
Optical system	Greenough type (zooming type)	Greenough type (zooming type), trinocular tube
Zoom ratio	7.5 : 1	
Zoom range	0.67-5x (with 0.67/1/2/3/4/5x stops)	
Total magnification	3.35-300x (depending on eyepiece and auxiliary objective used)	
Straight tube	—	Built-in C-mount 0.55x magnification lens (F.N. 11), compatible with 2/3 in. or smaller CCD
Tubes	Fixed type Eyepiece inclination: 45° Interpupillary distance adjustment: 52-75 mm	
Eyepieces (with diopter adjustment)	C-W 10xB (F.N. 22), C-W 15x (F.N. 16), C-W 20x (F.N. 12.5), C-W 30x (F.N. 7)	
Auxiliary objectives	G-AL 0.5x (W.D. 211 mm), G-AL 0.7x (W.D. 150 mm), G-AL 1.5x (W.D. 61 mm), G-AL 2x (W.D. 43.5 mm), G-AL ERG 0.77–1.06x (W.D. 102–48mm)	
Working distance	115 mm (standard)	
Airtight construction	JIS Degrees of protection provided by enclosures IPX1	—
Weight (approx.)	1.6 kg (body)	1.8 kg (body)

F.N.: Field Number

Dimensions

SMZ745 set SMZ745 + C-PSN Plain Stand/CN

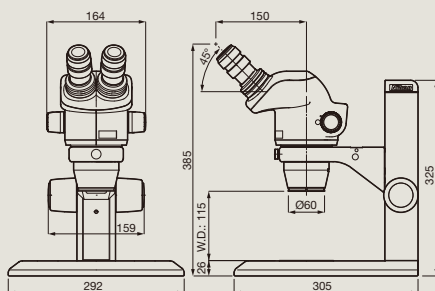

SMZ745T set SMZ745T + C-PSN Plain Stand/CN

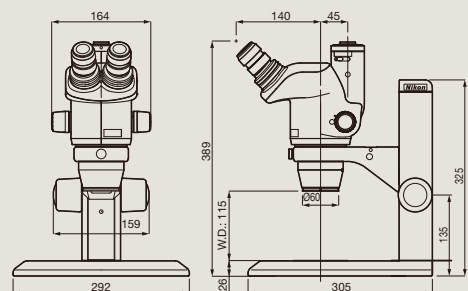

Unit: mm

Greenough Type Stereo Microscope

SMZ445/460

Designed for excellent cost performance

- The SMZ445 has a 45° eyepiece tube inclination, and the SMZ460 has a 60° eyepiece tube inclination, which is ideal for embedded use.
- Compact design with ease-of-use and high optical performance.
- ESD protection guards against electrostatic damage to samples.



Specifications

	SMZ445	SMZ460
Optical system	Greenough type (zooming type)	
Zooming ratio	4.4 : 1	4.3 : 1
Zooming range	0.8–3.5x	0.7–3x
Total magnification	4–70x	3.5–60x
Tube	Eyeiece inclination: 45° Interpupillary distance adjustment: 54–75 mm Eyeiece diopter adjustable for both eyes	Eyeiece inclination: 60° Interpupillary distance adjustment: 54–75 mm Eyeiece diopter adjustable for both eyes
Eyepieces	SM 10xB (F.N. 21), SM 15xB (F.N. 14), SM 20xB (F.N. 12)	
Auxiliary objectives (option)	AL5 (0.5x), AL7 (0.7x)	
Working distance	100 mm (standard)	
Weight (approx.)	1.0 kg (body)	1.1 kg (body)

Dimensions

SMZ445 SMZ445 + C-PSN Compact Stand/CN

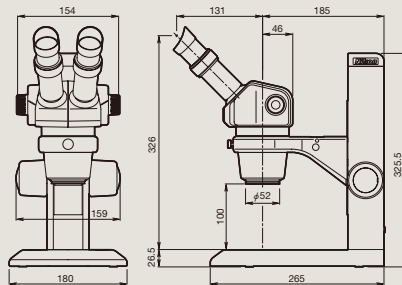

SMZ460 SMZ460 + C-FMBN Focusing Mount BN

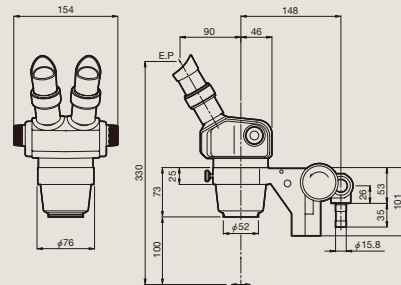

Unit: mm

Greenough Type Stereo Microscope

SMZ-2

High-resolution optics ideal for inspection, assembly, and measurement

- Compact design with horizontally positioned zooming ring (rotation: 90°)
- Eyepiece inclination of 45° for comfortable observation



Specifications

	SMZ-2
Optical system	Greenough type (zooming type)
Zooming ratio	5 : 1
Zooming range	0.8–4x
Total magnification	4.8–120x (Depending on eyepiece and auxiliary objective used.)
Tube	Eyeiece inclination: 45° Interpupillary distance adjustment: 56–75 mm
Eyepieces (with diopter adjustment)	SM E10xA (F.N. 23, standard), SM 15xB (F.N. 14), SM 20xB (F.N. 12), C-W30x (F.N. 7)
Auxiliary objectives	AL5 (0.6x), AL7 (0.8x)
Working distance	77.5 mm (with standard configuration)
Weight (approx.)	1.6 kg (body), 1.9 kg (stand)

Dimensions

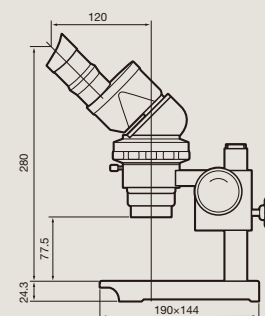

Unit: mm

Wide range of dedicated accessories for SMZ25/SMZ18 for all types of observation

Base Unit, Focus Unit, Stand/Focus Mount

Base Unit

Nikon has improved ease of use by moving the controls to the front of the base, including the brightness adjustment dial and the on/off switch.

Fiber DIA base

The Fiber DIA base features condenser lenses that can be switched between low and high magnifications. Furthermore, the OCC illumination system allows high-contrast illumination.



1 P2-DBF Fiber Diascopic Illumination Base

Slim Bases

The slimmer LED DIA Base and Plain Base help increase efficiency of sample manipulation by bringing the level of the sample closer to the table.



2 P2-DBL LED Diascopic Illumination Base



3 P2-PB Plain Base

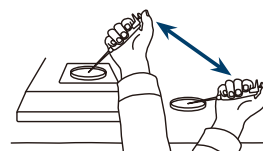

Conventional base



Slim base

Focus Unit

The focus unit is combined with the base unit. Choose from either a manual or motorized focus unit.



1 P2-MFU Motorized Focus Unit

2 P2-FU Focus Unit

Stand/Focus Mount

SMZ18

SMZ18 can be mounted on various compact stands using a focus mount.



1 P2-FMDN Focus Mount
2 P-PS32 Plain Stand

3 P-DSL32 LED Diascopic Illumination Stand

4 P-DSF32 Fiber Diascopic Illumination Stand

SHR Plan Apo Objective Series

The SHR Plan Apo series features higher NA, wider field of view and superior flatness and color aberration correction. These objective lenses can be seamlessly switched because all magnifications have the same parfocal distance. The bayonet mount design allows lenses to be safely and easily removed.



1 P2-SHR Plan Apo 0.5x
2 P2-SHR Plan Apo 1x
3 P2-SHR Plan Apo 1.6x
4 P2-SHR Plan Apo 2x

		SHR Plan Apo 0.5x	SHR Plan Apo 1x	SHR Plan Apo 1.6x	SHR Plan Apo 2x
Maximum NA	SMZ25	0.078	0.156	0.25	0.312
	SMZ18	0.075	0.15	0.24	0.3
Working distance		71 mm	60 mm	30 mm	20 mm
Correction ring		—	—	—	3 mm water depth
Wavelength		380-700 nm			

Tubes

Choose from two types of tilting trinocular tube and one type of low eyelevel trinocular tube. All tubes have a camera port for seamless integration with the Digital Sight series.



1 P2-TERG100 Trinocular Tilting Tube (eyepiece: port 100:0 / 0:100)



2 P2-TERG50 Trinocular Tilting Tube (eyepiece: port 100:0/50:50)



3 P2-TL100 Trinocular Tube L (eyepiece: port 100:0 / 0:100)

Nosepiece/Focus Mount Adapter

Both single and double nosepieces are available.



1 P2-RNI2 Intelligent Nosepiece



2 P2-FM Focus Mount Adapter

Stage

The stage features an XY stroke of 6x4* inches (150 mm x 100 mm) and can be attached to any of the bases, making it effective for capturing large images when used in combination with imaging software NIS-Elements. A sliding stage and tilting stage are also available. *Limited Y travel with 32 mm column bases



P-SXY64 XY Stage

Remote Control

Nikon offers a remote control unit that can be used to operate the microscope and capture images by hand. A footswitch is also available, allowing the user to operate the microscope and capture images by foot, freeing the hands for sample manipulation.



P2-RC Remote Controller



1 AZ-PCR Photo Release
2 AZ-FSW Foot Switch

Darkfield Observation Accessory

Darkfield viewing is possible simply by attaching the darkfield unit to the base.

- 1 P-DF2 LED Darkfield Unit
- 2 Shading cover



Polarizing Observation Accessory

The analyzer is attached to the objective and the polarizer to the base or stand to enable polarized viewing.

- 1 P2-POL Simple Polarizing Attachment



Epi-fluorescence Set

Motorized Epi-fluorescence Set

The fluorescent turret can be operated using the remote control or imaging software NIS-Elements.

- 1 P2-EFLM Motorized Epi Fluorescence Attachment
- 2 Light shading Plate (comes with Fluorescence Attachment)
- 3 P2-EFL Filter Cube (GFP-B/GFP-L/RFP)
- 4 P2-EFLBF Filter Cube (Brightfield)
- 5 P2-CTLA Control Box
- 6 P2-RC Remote Controller
- 7 P2-CIA QL1x/0.5x 1/4 λ Plate



Combinations with SMZ25

Manual Epi-fluorescence Set

An easy-to-use manual model for Nikon's high-performance epi-fluorescence attachment.

- 1 P2-EFLI Epi Fluorescence Attachment
- 2 Light shading Plate (comes with Fluorescence Attachment)
- 3 P2-EFL Filter Cube (GFP-B/GFP-L/RFP)
- 4 P2-EFLBF Filter Cube (Brightfield)
- 5 P2-CTLB Control Box
- 6 P2-CIA QL1x/0.5x 1/4 λ Plate



Combinations with SMZ18

Fiber Illuminator Set

Flexible Double Arm Fiber Illumination Set

The direction and angle of illumination can be changed to suit the sample by making adjustments with these double arms. The fiber holder position can also be changed to obtain the optimal position for illuminating samples.

- ① C-FDF Flexible Double Arm Fiber Illumination Unit
- ② C-FIDH Fiber Holder
- ③ C-FLED2 LED Light Source for Fiber Illuminator



Combination with SMZ18

Ring Fiber Illumination Set

This ring fiber illumination set features an episcopic illumination unit that effectively captures images (can be used with 1x and 0.5x objective lenses).

- ① P2-FIR Ring Fiber Illumination Unit
- ② C-FLED2 LED Light Source for Fiber Illuminator



Combination with SMZ18

Coaxial Illuminator

The coaxial light illuminator makes it possible to view light reflected from the surface of a sample. It is ideal for shooting shadow-less images of thick samples.

- ① P2-CI Coaxial Epi Illuminator
- ② C-FLED2 LED Light Source for Fiber Illuminator
- ③ P2-CIA QL1x/0.5x 1/4 λ Plate



Combination with SMZ18

Ring LED Illuminator

Ring LED illuminator is equipped with high-intensity, long-life (20,000 hours) LEDs. The illuminator's dial adjusts the intensity of the white LED.

- ① P2-FIRL2 LED Ring Illumination Unit



Combination with SMZ25

A variety of accessories are available for stereoscopic observations



Plan Apo WF series

Objectives

A wide selection with various magnifications and working distances is available, including high-NA, high-resolution and wide-viewfield Plan Apo WF series objectives with superior image flatness and chromatic aberration correction.



Objectives	Working distance (mm)	Zoom magnification	NA	Actual FOV*1
Plan Apo	82	0.63x	0.0095	69.8
		8x	0.0525	5.5
	107	0.63x	0.0143	46.6
		8x	0.0788	3.7
ED Plan	70	0.63x	0.0190	34.9
		8x	0.1050	2.8
	44	0.63x	0.0285	23.3
		8x	0.1575	1.8
35	0.63x	0.0380	17.5	
	8x	0.2100	1.4	

*1 With C-W10xB eyepiece



Objectives	Working distance (mm)	Zoom magnification	NA	Actual FOV*1
Achro	189	1x	0.0145	44
		8x	0.0525	5.5
Plan	78	1x	0.0290	22
		8x	0.1050	2.75

*1 With C-W10xB eyepiece

Auxiliary Objectives

Microscopes	Auxiliary objectives	Working distance (mm)
SMZ745/745T	G-AL ERG 0.77-1.06x	102-48
	G-AL 0.5x	211
	G-AL 0.7x	150
	G-AL 1.5x	61
	G-AL 2x	43.5

Microscopes	Auxiliary objectives	Working distance (mm)
SMZ445/460	AL5 (0.5x)	181
	AL7 (0.7x)	127.5
SMZ-2	AL5 (0.5x)	103
	AL7 (0.7x)	95

Nosepieces

Double nosepiece with two-objective switchover. Easy changeover from stereo position (stereoscopic view) to mono position (on-axis view) is possible by simply moving the objective lens to the right.

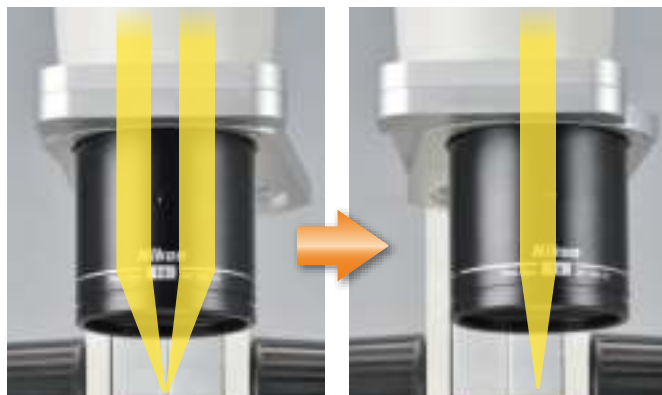

Stereoscopic view

On-axis view

P-RN2 Nosepiece SMZ1270/1270i SMZ800N

Observations with wider zoom ranges are possible by simply switching between two objectives.



P-RN12 Intelligent Nosepiece SMZ1270i

Enables easy switchover between two objectives. In combination with the Digital Sight series digital camera, it automatically detects the data of objective in use.



Tubes/Eye-level Riser SMZ1270/1270i SMZ800N

Various ergonomic tubes with different inclination angles enable suitable eye levels to be selected for observation, even when an intermediate tube or illuminator is attached. Trinocular tubes are also equipped with camera ports.

P-B Binocular Tube

20° inclination angle allows observation without having to lean forward and reduces fatigue during long-time operations.



P-TERG100/P-TERG50 Trinocular Tilting Tube

Allows continuous adjustment of the eyepiece inclination from 0° to 30°. Optical path switching ratio of eyepiece:camera port is 100:0/0:100 with P-TERG100 and 100:0/50:50 with P-TERG50.



P-TERG100 Trinocular Tilting Tube

P-T100 Trinocular Tube

The eyepoint height can be raised 106 mm by tilting the eyepieces 180° up. Optical path switching ratio of eyepiece:camera port is 100:0/0:100.



P-IER Eye-level Riser

Increases the eyepoint height 25 mm per riser for a total of 50 mm.



Intermediate Tubes SMZ1270/1270i SMZ800N

Various intermediate accessories are available that can be inserted between the microscope zooming body and tube.

P-IBSS2 Beam Splitter S2

Using a beam splitter and camera adapter, a digital camera can be attached to the binocular eyepiece tube for imaging. Optical path switching ratio of left eyepiece:right eyepiece:camera port is 100:100:0/100:50:50.

P-THSS Teaching Head

Simultaneous observation of the same viewfield is possible between the eyepiece lenses of both teaching head and microscope, making it ideal for educational purposes. The pointer can indicate target points in the viewfield during observation.

P-IDT Drawing Tube

Drawing sample images is possible by simply tracing observed images that are overlaid on top of drawings within the viewfield. The drawings can be removed from view by using the knob to block the light path.

Accessories

Stages

Stages allow smooth sample movement in order to change viewfield during observation.

C-SSL Dia-sliding Stage

Used for diascopic observation, this sliding stage can be easily moved in the desired direction simply with a light push. Travel range is within $\phi 38\text{mm}$.

SMZ1270/1270i SMZ800N
SMZ745/745T SMZ445/460

Can be used with the SMZ25 and SMZ18



Circular Floating Stage 2

Used for episcopic observation. Loaded with a sample, the stage can be easily moved in the desired direction simply with a light push to its edges. Travel range is within $\phi 40\text{mm}$.

SMZ1270/1270i SMZ800N
SMZ745/745T SMZ-2
SMZ445/460

Can be used with the SMZ25 and SMZ18



C-TRS Tilting Stage

This stage has a nonslip sheet and can be tilted 30° from its horizontal position.

SMZ1270/1270i SMZ800N
SMZ745/745T SMZ445/460
SMZ-2

Can be used with the SMZ25 and SMZ18



P-SXY64 XY Stage

The stage features an XY stroke of $150\text{ mm} \times 65\text{ mm}$. By attaching AZ100 stage adapters, it can be used for various applications. It can be used with both diascopic and episcopic illuminators.

SMZ1270/1270i SMZ800N
SMZ745/745T SMZ445/460



Observation Attachments

Various observation accessories are available that utilize diascopic and episcopic illuminations. They can be used for samples that are difficult to observe using standard illumination.

P-EFL Epi-fluorescence Attachment

Up to four epi-fluorescence filter cubes can be mounted. The fly-eye lens provides bright illumination up to the viewfield periphery.

SMZ1270/1270i
SMZ800N



P-DF2 LED Darkfield Unit

Equipped with the white light LED as the light source. Simply placing the unit on the stage enables darkfield observation.

SMZ1270/1270i
SMZ800N
SMZ745/745T



C-POL Polarizing Attachment

Simple polarizing observation is possible by placing the polarizer on the stage while the analyzer is attached to the tip of the objective lens.

SMZ1270/1270i SMZ800N
SMZ745/745T



Illumination Systems

Ring Illuminator

Provides a cone of light from above the sample to the center, minimizing unwanted shadow. Suitable for observation of electronic substrates.



C-FIR Plastic Fiber-optics Ring Illuminator

Illuminator is located away from microscope. It enables bright observation with high-intensity light without damaging sample with its heat.

SMZ1270/1270i SMZ800N SMZ745/745T
SMZ445/460* SMZ-2*

※ G-OBA60 Adapter is required.

Arm Illuminator/Episcopic Illuminator

The direction and angle of the illumination can be changed with simple adjustments of the flexible arm.



C-FID2 Double Arm Fiber Illuminator

It enables bright observation with high-intensity light without damaging sample with its heat. The direction and angle of illumination can be changed using the flexible arms.

SMZ1270/1270i SMZ800N
SMZ745/745T SMZ445/460
SMZ-2

C-FDF Flexible Double Arm Fiber Illumination Unit

It enables bright observation with high-intensity light without damaging sample with its heat. The direction and angle of illumination can be changed using the fiber holder.

SMZ1270/1270i SMZ800N
SMZ745/745T SMZ445/460

C-LSL2 LED Episcopic Illuminator

In combination with C-PSN Plain Stand/CN and C-PSCN Compact Stand/CN, illumination angle flexibility is possible from the back of the microscope. By attaching arms, flexible change of direction and angle of illumination is possible.

SMZ1270/1270i SMZ800N SMZ745/745T SMZ445/460

Coaxial Illuminator

Suitable for brightfield observation for high-reflectance flat surface samples such as polished metals and wafers.



P-CI Coaxial Episcopic Illuminator

Coaxial illuminator for parallel optics-type stereo microscopes. Provides high-intensity illumination for the entire view field.

*1/4 λ plate is required

SMZ1270/1270i SMZ800N

Stands



C-PSN Plain Stand/CN
C-PSCN Compact Stand/CN

Offers a comfortable work area and allows easy handling of samples. C-PSCN has a small base that saves desk space.



P-PS32 Plain Stand

Features a slim design with a $\phi 180$ mm stage plate and 160 mm width between the pillar and optical axis to boost working efficiency.



C-LEDS Hybrid LED Stand

Both episcopic and diascope observations are possible and can be conducted simultaneously. The space-saving built-in illuminator can be switched and adjusted with ease.

Type	Episcopic	Episcopic	Episcopic/Diascopic
Illumination method	—	—	Epi-oblique*, brightfield
Built-in filter	—	—	—
Fine focus knob	—	—	—
Observation magnification	With all objectives, at all zoom ranges	With all objectives, at all zoom ranges	With all objectives, at all zoom ranges
Microscopes	SMZ1270/1270i SMZ800N SMZ745/745T SMZ445/460 P-PS32 can be used with the SMZ18.		

* The illumination area is limited by conditions of use.



C-DS Diascopic Stand S

Features a hand rest for comfortable operation. Used in conjunction with C-DSL2 LED Unit for Dia Illumination Stand.



P-DSL32 LED Diascopic Illumination Stand

The OCC illumination system allows colorless and transparent samples to be observed in high relief. Compact slim-type base enhances operation efficiency.



P-DSF32 Fiber Diascopic Illumination Stand

Light source is located away from microscope, enabling bright observation with high-intensity light without damaging sample with its heat.

Type	Diascopic	Diascopic	Diascopic
Illumination method	Brightfield	Brightfield, OCC**	Brightfield, OCC**
Built-in filter	—	Not required ($\phi 45$ mm filter slot provided)	NCB11, ND4/16
Fine focus knob	—	Included	Included
Observation magnification	With all objectives, at all zoom ranges	0.5x objective is compatible with zoom magnifications higher than 1.5x.	0.5x objective is compatible with zoom magnifications higher than 1.5x.
Microscopes	SMZ1270/1270i SMZ800N SMZ745/745T SMZ445/460 P-DSL32 and P-DSF32 can be used with the SMZ18.		

** Conditions of use vary depending on objective in use.

Universal Table Stands/Focusing Mounts

Universal Table Stands G-US1A/G-US2

These stands are handy in microscopy with large samples not loaded onto the standard stand. The microscope zooming body is mounted to the stand arm via a focusing mount. The G-US1A is a table clamp type (table top thickness: 3 to 53 mm).

- Used in conjunction with the C-FMBN Focusing Mount BN on the SMZ1270/1270i/800N/SMZ745/745T/445/460.
- Used in conjunction with the SM Focusing Mount and the G-USA SM US Adapter on the SMZ-2.
- Cannot be used with the SMZ1270/1270i/800N when intermediate tube is mounted on these models.

G-US1A Universal Table Stand 1

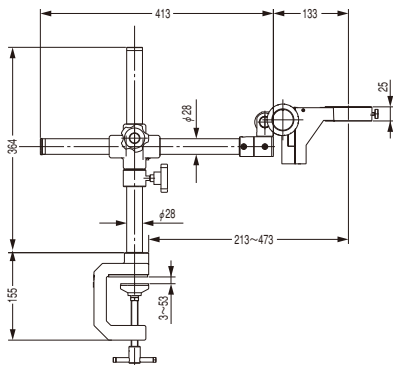

G-US2 Universal Table Stand 2

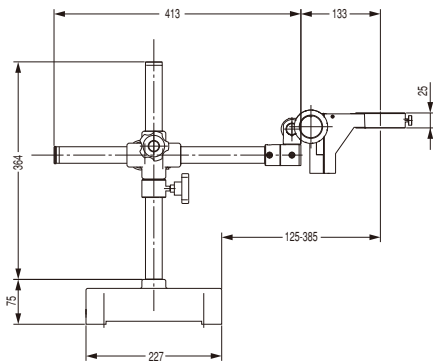

Unit: mm

Universal Table Stand US-3

Not only can it be used for a large sample, but this extremely stable stand also easily accommodates intermediate tubes.

- Used in conjunction with the C-FMAN Focusing Mount AN on the SMZ1270/1270i/800N/745/745T/445/460.
- Used in conjunction with the SM Focusing Mount on the SMZ-2.

Universal Table Stand US-3

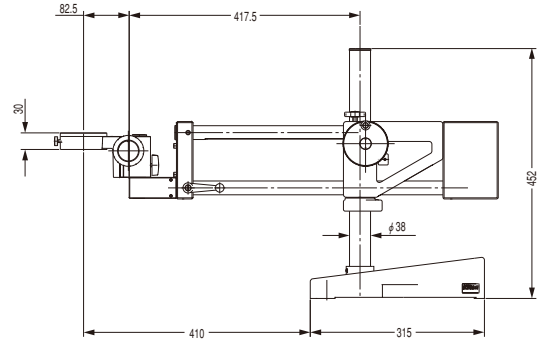

Can be installed on the top or bottom edge.

Unit: mm

Specifications

Model	Universal Table Stand		
	G-US1A	G-US2	US-3
Vertical cross travel	253mm	254mm	229mm
Horizontal cross travel	260mm		272mm
Weight (approx.)	4.4kg	23.0kg	30.5kg
C-FMAN Focusing Mount AN	—	—	○
C-FMBN Focusing Mount BN	○	—	—
C-FMCN Focusing Mount CN	—	—	—
SM Focusing Mount	○*	—	○

○: Possible * G-USA Adapter is required

G-USA Adapter

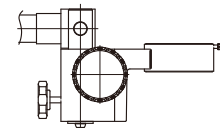
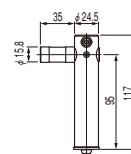

The image is a configuration sample with the SM Focusing Mount.

Focusing Mounts

Various types of focusing mounts are available depending on use. They are used to incorporate stereo microscope bodies into IC bonders or other devices (SM Focusing Mount is for SMZ-2). These mounts can also be used when attaching microscopes to Universal Table Stands.

C-FMAN Focusing Mount AN
SM Focusing Mount

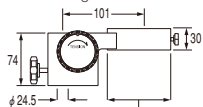

φ76mm: C-FMAN Focusing Mount AN
φ62mm: SM Focusing Mount

C-FMBN Focusing Mount BN

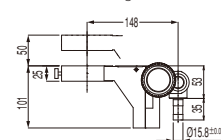

C-FMCN Focusing Mount CN

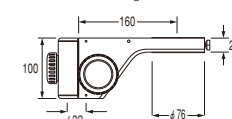

Unit: mm

	C-FMAN Focusing Mount AN	C-FMBN Focusing Mount BN	C-FMCN Focusing Mount CN	SM Focusing Mount
Focusing area	40mm	50mm	50mm	40mm
Weight (approx.)	0.6kg	0.8kg	1.6kg	0.6kg
Antistatic function	○	○	—	—
Compatible microscopes	SMZ1270/1270i/800N/745/745T/445/460			SMZ-2

System Diagrams (SMZ25/SMZ18)

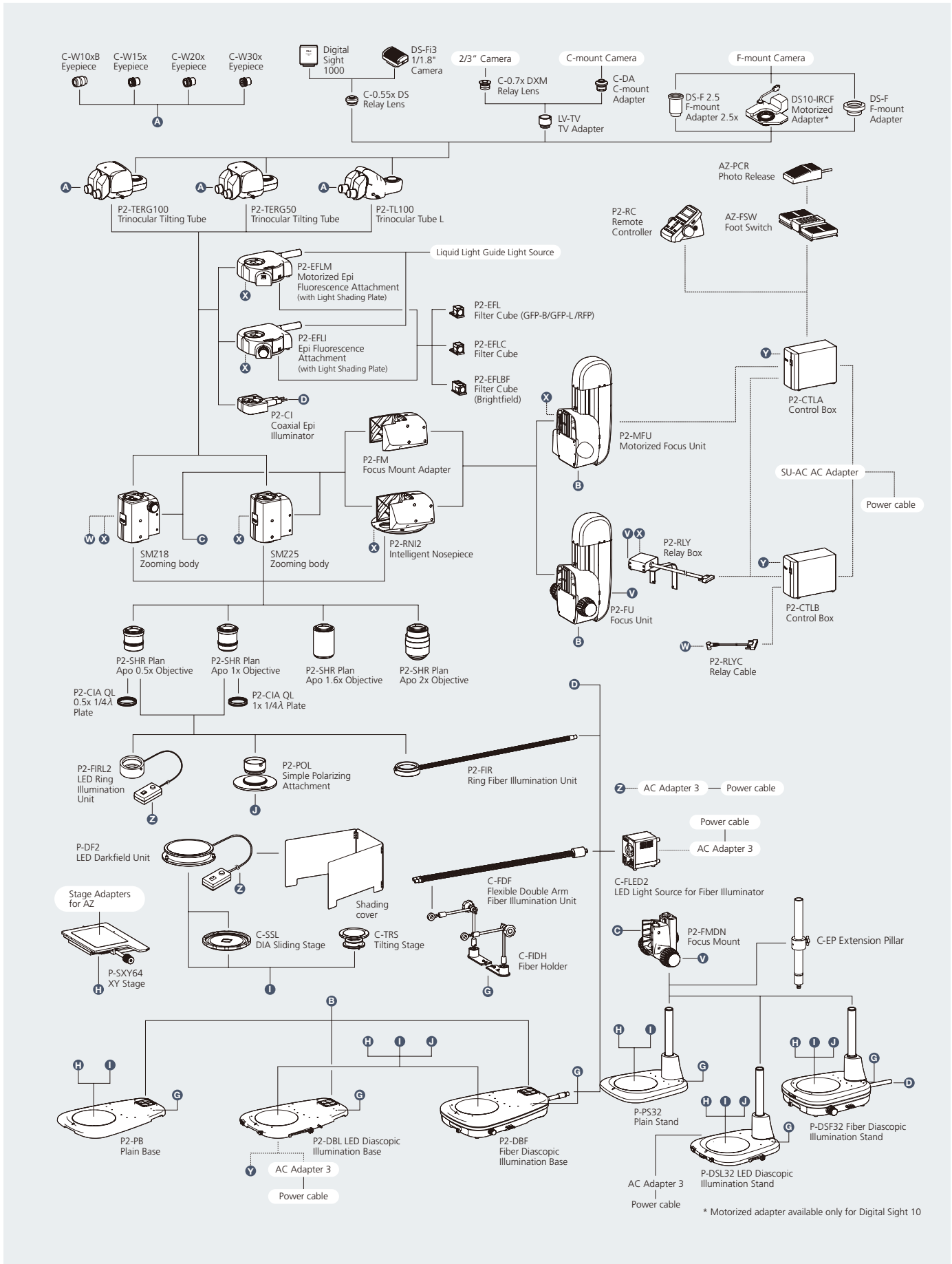

Specifications/Dimensions (SMZ25/SMZ18)

Specifications		SMZ25	SMZ18
Zooming body			
Optical system	Parallel-optics type (zooming type), apochromatic optical system		
Zoom	Motorized	Manual	
Zoom ratio	25:1	18:1	
Zoom range	0.63-15.75x	0.75-13.5x (with 0.75/1/2/3/4/5/6/8/10/12/13.5x click stops)	
Aperture diaphragm	Zooming body built-in		
Objectives NA, WD (mm)			
P2-SHR Plan Apo 2x	0.312, 20 (with a correction ring for water 0 to 3 mm in depth)	0.3, 20 (with a correction ring for water 0 to 3 mm in depth)	
P2-SHR Plan Apo 1.6x	0.25, 30	0.24, 30	
P2-SHR Plan Apo 1x	0.156, 60	0.15, 60	
P2-SHR Plan Apo 0.5x	0.078, 71	0.075, 71	
Total Magnification (using C-W10xB eyepieces)	3.15-315x (depending on objective used)	3.75-270x (depending on objective used)	
Eyepieces (F.O.V. mm)	<ul style="list-style-type: none"> • C-W10xB (22) • C-W 15x (16) • C-W 20x (12.5) • C-W 30x (7) 		
Tubes (eyepiece/port)	<ul style="list-style-type: none"> • P2-TERG 100 Trinocular Tilting Tube (100/0 : 0/100) • P2-TERG 50 Trinocular Tilting Tube (100/0 : 50/50) Inclination angle : 0-30 degree • P2-TL100 Trinocular Tube L (100/0 : 0/100) Inclination angle : 15 degree 		
Focusing Unit (stroke from objective's parfocal point)	<ul style="list-style-type: none"> • P2-MFU Motorized Focus Unit (up 96 mm/down 4 mm) • P2-FU Focus Unit (up 97 mm/down 5 mm) 		
Focus mount adapter/nosepiece	<ul style="list-style-type: none"> • P2-FM Focus Mount Adapter • P2-RNI2 Intelligent Nosepiece (2 objectives can be attached) • P2-FMDN Focus Mount (for P-PS32/P-DSL32/P-DSF32 stands) 		
Bases/stand	<ul style="list-style-type: none"> • P2-PB Plain Base • P2-DBL LED Diascopic Illumination Base (OCC illuminator built-in) • P2-DBF Fiber Diascopic Illumination Base • P-PS32 Plain Stand (only for SMZ18) • P-DSL32 LED Diascopic Illumination Stand (OCC illuminator built in) (only for SMZ18) • P-DSF32 Fiber Diascopic Illumination Stand (only for SMZ18) 		
Stages	<ul style="list-style-type: none"> • P-SXY64 Stage • C-SSL DIA Sliding Stage • C-TRS Tilting Stage 		
Observation methods	Brightfield, Epi Fluorescence, Simple Polarizing (with P2-POL Simple Polarizing Attachment), Darkfield (with P-DF2 LED Darkfield Unit), Oblique Lighting		
Epi-fluorescence attachments	4 filter cubes mountable, fly-eye lens built-in <ul style="list-style-type: none"> • P2-EFLM Motorized Epi Fluorescence Attachment • P2-EFLI Epi Fluorescence Attachment 		
Episcopic illuminators	Use with fiber light source <ul style="list-style-type: none"> • P2-CI Coaxial Epi Illuminator • P2-FIR Ring Fiber Illumination Unit • C-FDF Flexible Double Arm Fiber Illumination Unit 		
Episcopic light source	<ul style="list-style-type: none"> • C-FLED2 LED Light Source for fiber illuminator 		
Weight (approx.)	32 kg (Motorized Epi Fluorescence Attachment configuration with Trinocular Tilting Tube, Motorized Focus Unit, Intelligent Nosepiece, LED DIA Base and Objectives 1x and 0.5x)	30 kg (Epi Fluorescence Attachment configuration with Trinocular Tilting Tube, Focus Unit, Intelligent Nosepiece, LED DIA Base and Objectives 1x and 0.5x)	
Power consumption (approx.)	30W (Motorized Epi Fluorescence Attachment configuration with Trinocular Tilting Tube, Motorized Focus Unit, Intelligent Nosepiece and LED DIA Base)	10W (Epi Fluorescence Attachment configuration with Trinocular Tilting Tube, Focus Unit, Intelligent Nosepiece and LED DIA Base)	

Dimensions

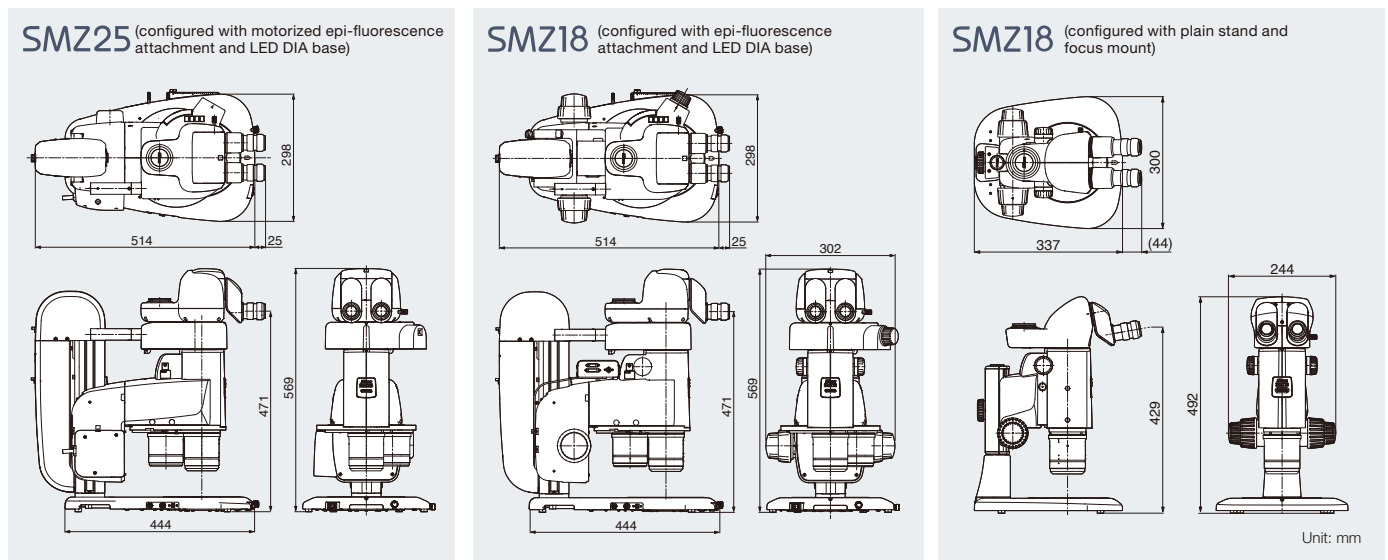

System Diagrams (SMZ1270/1270i, SMZ800N, SMZ745/745T)

SMZ1270/1270i/800N

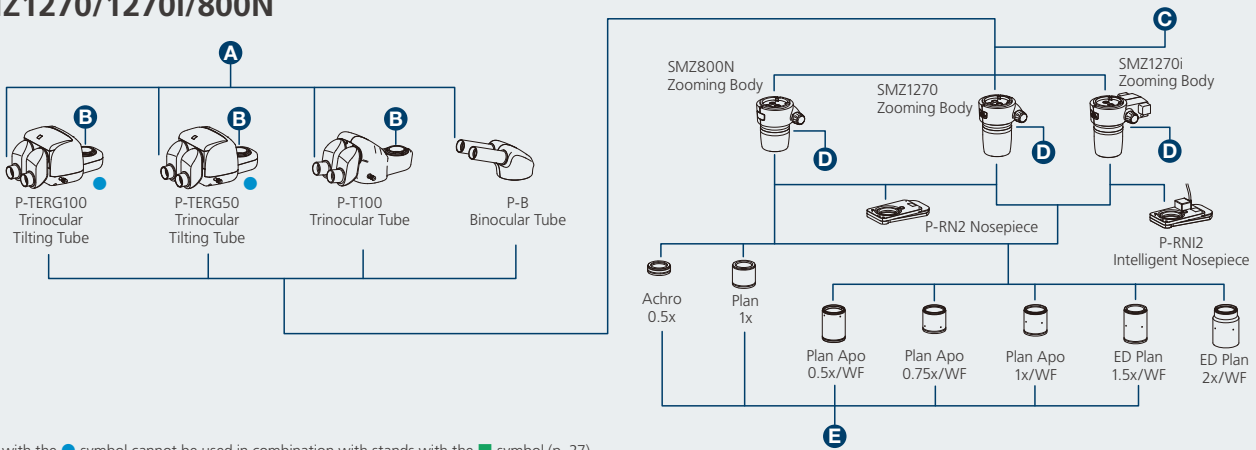

Tubes with the ● symbol cannot be used in combination with stands with the ■ symbol (p. 27).

SMZ745/745T

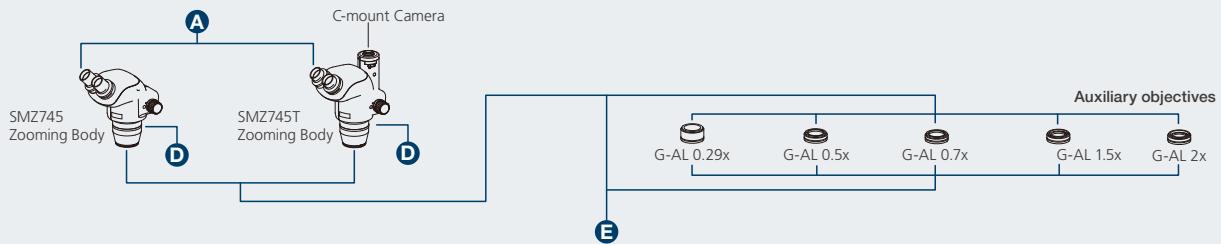

Eyepieces/Camera Adapters

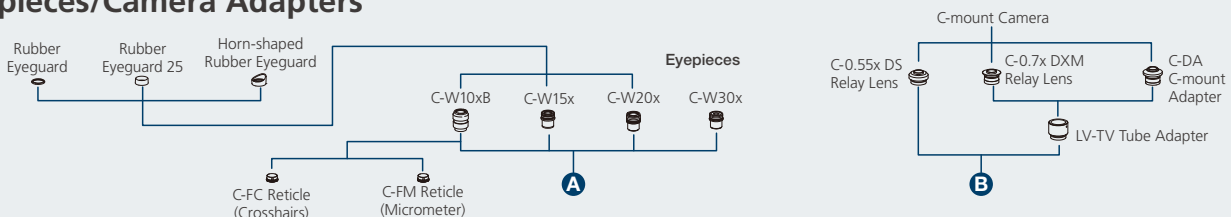

Intermediate Tubes

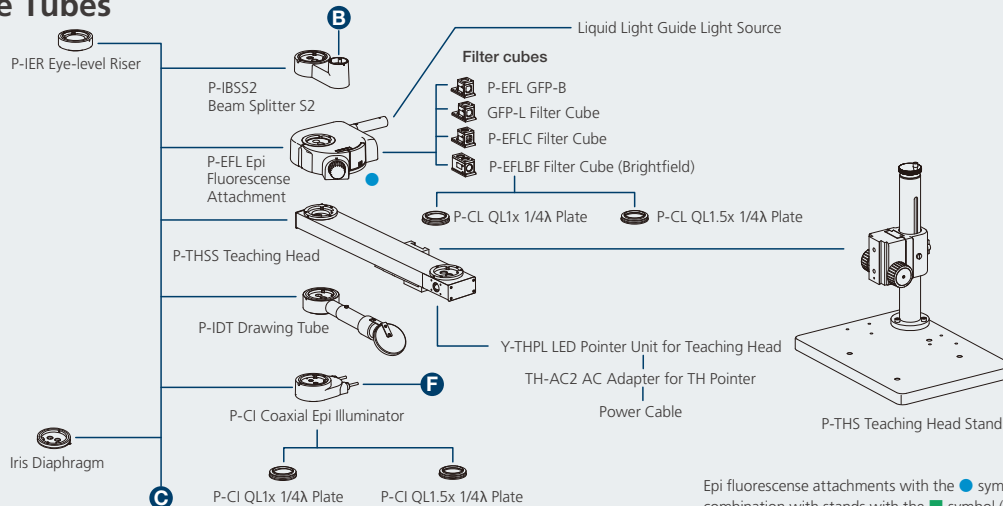

Epi fluorescence attachments with the ● symbol cannot be used in combination with stands with the ■ symbol (p. 27).

Illuminators

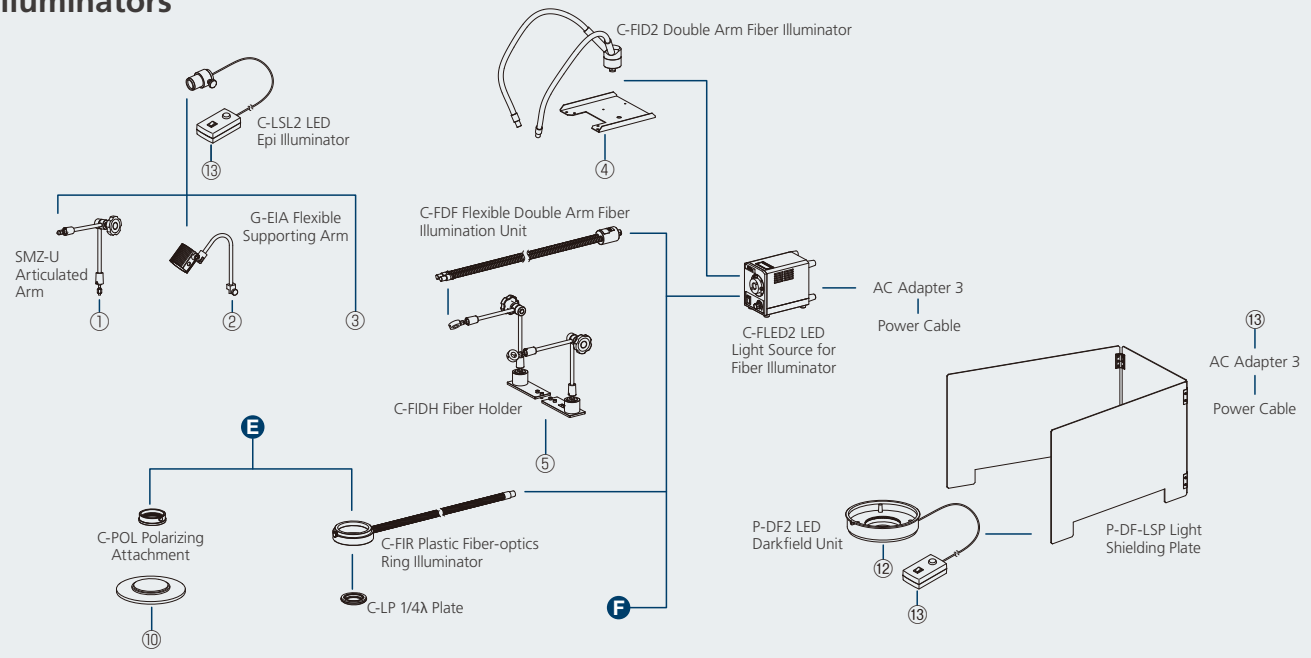

Stands/Stages

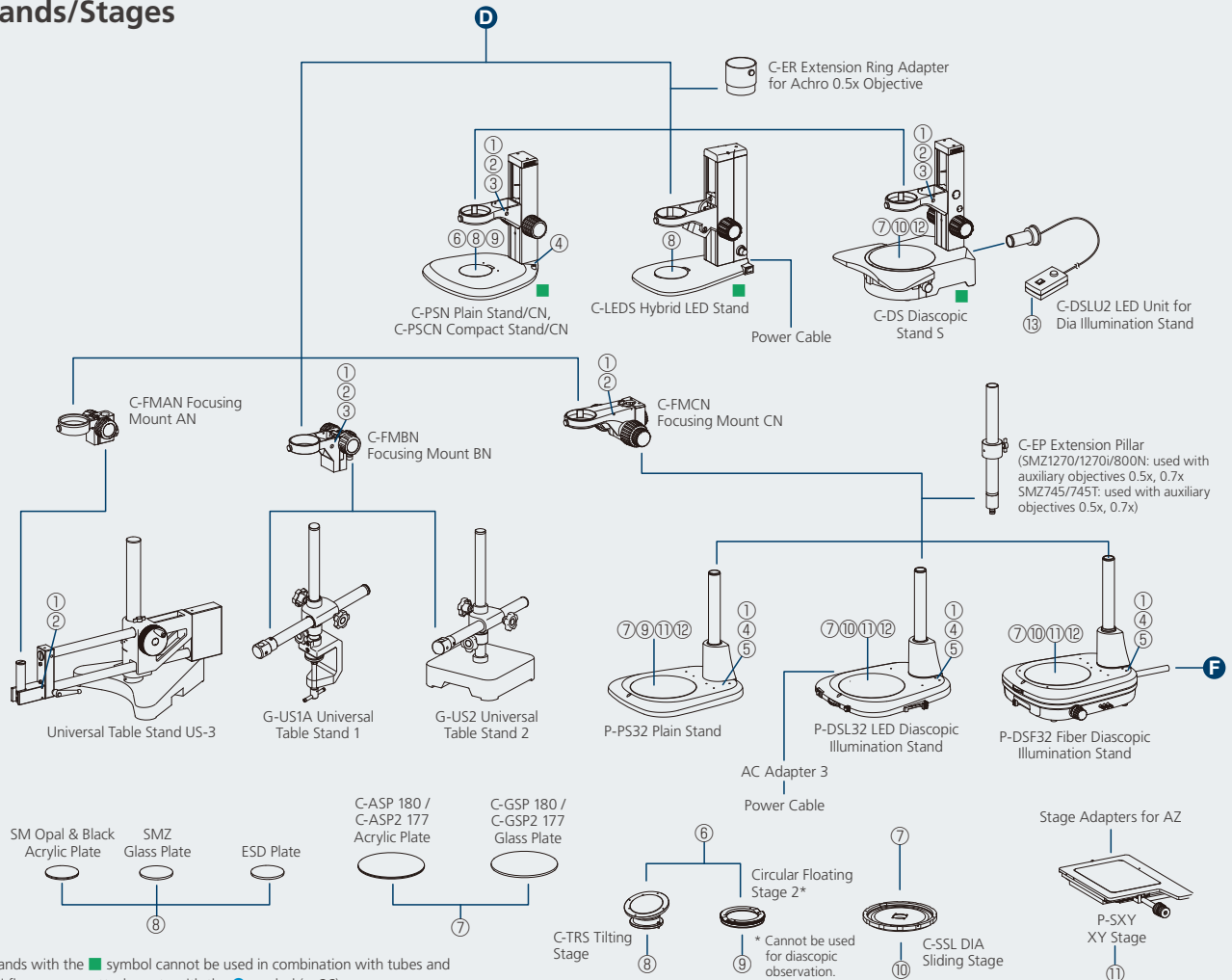

Stands with the ■ symbol cannot be used in combination with tubes and epi fluorescence attachments with the ● symbol (p. 26).

Specifications

Parallel-optics type		
Model	SMZ25	SMZ18
Optical system	Parallel-optics type (zooming type)	
Zoom ratio	25:1	18:1
Zoom range	0.63-15.75x	0.75-13.5x
Total magnification* (When coaxial episcopic illuminator is attached)	3.15-945x (12.5-472x)	3.75-810x (19-405x)
Tubes	P2-TERG 100 Trinocular Tilting Tube, P2-TERG 50 Trinocular Tilting Tube, P2-TL100 Trinocular Tube L	
Eyepiece inclination	P2-TERG 100/50: 0°-30°, P2-TL100: 15°	
Interpupillary distance adjustment	P2-TERG 100/50: 50 mm or wider P2-TL100: 50-75mm	
Eyepieces	C-W10xB (F.N. 22), C-W15x (F.N. 16), C-W20x (F.N. 12.5), C-W30x (F.N. 7) (with diopter adjustment)	
Objectives	P2-SHR Plan Apo 0.5x, P2-SHR Plan Apo 1x, P2-SHR Plan Apo 1.6x, P2-SHR Plan Apo 2x	
Working distance (with standard configuration or 1x objective)	60 mm	
Weight (approx.)	32 kg (motorized Epi Fluorescence Attachment configuration)	10 kg (with Plain Stand and Ring LED set)

* Depending on eyepiece and objective used

Greenough type		
Model	SMZ745/745T	SMZ445
Optical system	Greenough type (zooming type) Trinocular Tube (SMZ745T)	Greenough type (zooming type)
Zoom ratio	7.5 : 1	4.4 : 1
Zoom range	0.67-5x	0.8-3.5x
Total magnification*	3.35-300x	4-70x
Tubes	Fixed (binocular tube: SMZ745, trinocular tube: SMZ745T)	Fixed
Eyepiece inclination	45°	45°
Interpupillary distance adjustment	52-75mm	54-75mm
Eyepieces	C-W10xB (F.N. 22), C-W15x (F.N. 16), C-W20x (F.N. 12.5), C-W30x (F.N. 7) (with diopter adjustment)	SM 10xB (F.N. 21), SM 15xB (F.N. 14), SM 20xB (F.N. 12)
Objectives	—	—
Auxiliary objectives	G-AL 0.5x (W.D. 211mm), 0.7x (W.D. 150mm), 1.5x (W.D. 61mm), 2x (W.D. 43.5mm)	SM-AL 0.5x, 0.7x
Working distance (with standard configuration or 1x objective)	115mm	100mm
Weight (approx.)	1.6kg (SMZ745 body) 1.8kg (SMZ745T body)	1.0kg (body)

* Depending on eyepiece and objective used

SMZ1270	SMZ1270i	SMZ800N
Parallel-optics type (zooming type)		
12.7:1		8:1
0.63 – 8x		1 – 8x
3.15 – 480x (depending on eyepiece and objectives) (with coaxial episcopic illuminator: 15 – 540x)		5 – 480x (depending on eyepiece and objectives) (coaxial episcopic illuminator: 22.5 – 540x)
P-B Binocular Tube, P-T100 Trinocular Tube, P-TERG 100 Trinocular Tilting Tube, P-TERG 50 Trinocular Tilting Tube		
P-B: 20° P-T100: 10° P-TERG100/50: 0°-30°		
P-B: 48–75mm P-TERG100/50: 50 mm or wider		
C-W10xB (F.N. 22), C-W15x (F.N. 16), C-W20x (F.N. 12.5), C-W30x (F.N. 7) (with diopter adjustment)		
Plan Apo 0.5x/WF, Plan Apo 0.75x/WF, Plan Apo 1x/WF, ED Plan 1.5x/WF, ED Plan 2x/WF		Plan Apo 0.5x/WF, Plan Apo 0.75x/WF, Plan Apo 1x/WF, ED Plan 1.5x/WF, ED Plan 2x/WF, Plan 1x, Achrom 0.5x
70 mm		78 mm
9.8 kg (with Binocular Tube + LED Diascopic Illumination Stand)	11.9 kg (with Trinocular Tilting Tube + LED Diascopic Illumination Stand)	6.8 kg (with Binocular Tube + Plain Stand)

SMZ460	SMZ-2
Greenough type (zooming type)	
4.3 : 1	5 : 1
0.7–3x	0.8–4x
3.5–60x	4.8–120x
Fixed	
60°	45°
54–75mm	56–75mm
SM 10xB (F.N. 21), SM 15xB (F.N. 14), SM 20xB (F.N. 12)	SM E10xA (F.N. 23, standard), SM 15xB (F.N. 14), SM 20xB (F.N. 12), C-W30x (F.N. 7)
—	0.8-4x
SM-AL 0.5x (W.D. 181mm), 0.7x (W.D. 127.5mm)	AL5 (0.6x, W.D. 103mm), AL7 (0.8x, W.D. 95mm)
100mm	77.5mm
1.1kg (body)	1.6kg (body), 1.9kg (Stand)

Related Products

Camera Head

Microscope Camera

Digital Sight 1000

2.0-megapixel Color Full HD



Microscope Camera

Digital Sight 10

23.9-megapixel Monochrome Color High-resolution



Monochrome Microscope Camera

Digital Sight 50M

60.0-megapixel Monochrome Cooled



Microscope Camera

DS-Fi3

5.9-megapixel Color High-resolution



Imaging Software NIS-Elements

Enables a wide range of advanced digital imaging capabilities using a desktop PC and tablet PC.

Using a desktop PC

F D Br Ar



Using a tablet PC

L

Simply installing NIS-Elements L on a tablet PC enables setting and control of microscope cameras, live image display, and image acquisition.

Note: NIS-Elements L is available only for Digital Sight 1000, DS-Fi3, and Digital Sight 10.

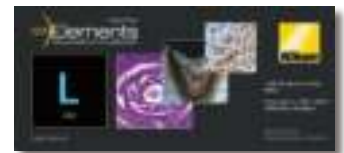

EDF (Extended Depth of Focus)

Captures multiple high-resolution images at different focal depths to create a single extended depth of focus image or quasi-3D image.

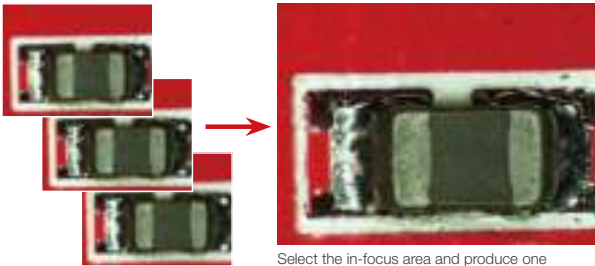

Select the in-focus area and produce one all-in-focus image

Multichannel (multicolor)

Multiple fluorescent channels can be captured in conjunction with other imaging methods, such as OCC or brightfield.

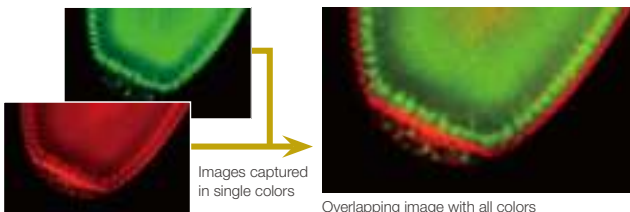

Images captured in single colors

Overlapping image with all colors

Individual cells resolved in a live drosophila embryo expressing GFP and mCherry

(Using SHR Plan Apo 2x at zoom magnification of 8x with SMZ25)
Image courtesy of Max V. Staller, Ph.D., Clarissa Scholes, and Angela DePace, Ph.D., Harvard Medical School

A wide variety of tools

NIS-Elements L enables the conducting of simple measurements on images, with input of lines and comments. These can also be written onto and saved with the image, and measurement data can be output.

Measurement function

- Line distance
- Area
- Circle
- Circle distance
- Pitch distance
- Angle



Annotate function

- Line
- Arrow
- Text
- Marker
- Polyline



Graticule/scale function

- Crosshairs
- Simple crosshairs
- Circle
- Grid
- Horizontal scale
- Vertical scale

Optical Systems

Parallel-optics type (zooming type)

This system has a parallel optical path into which various intermediate tubes, including a beam splitter, coaxial episcopic illuminator, epi-fluorescence attachment, teaching head, drawing tube and eye-level riser, can be inserted.

Greenough type (zooming type)

Allows a compact body that is suited for incorporation into other devices.

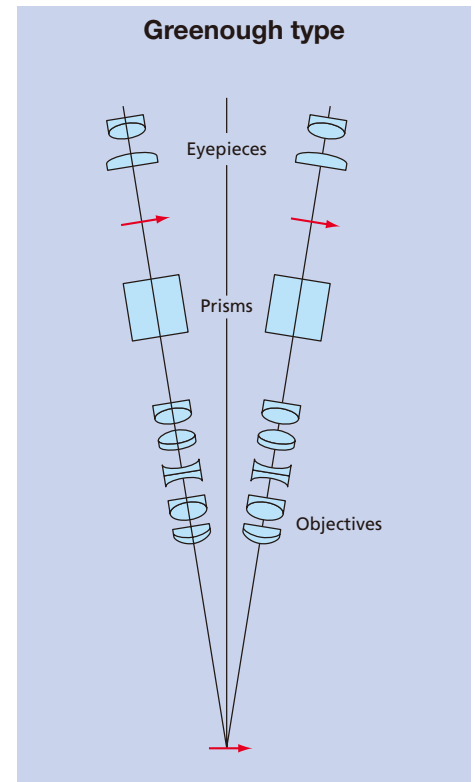
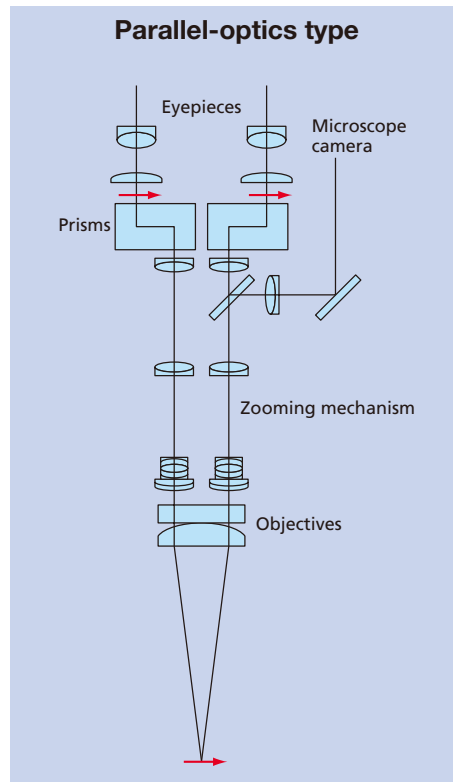

N.B. Export of the products* in this catalog is controlled under the Japanese Foreign Exchange and Foreign Trade Law. Appropriate export procedure shall be required in case of export from Japan.

*Products: Hardware and its technical information (including software)

Specifications and equipment are subject to change without any notice or obligation on the part of the manufacturer. January 2023
©2007-23 NIKON CORPORATION



WARNING

TO ENSURE CORRECT USAGE, READ THE CORRESPONDING MANUALS CAREFULLY BEFORE USING YOUR EQUIPMENT.



NIKON CORPORATION

Shinagawa Intercity Tower C, 2-15-3, Konan, Minato-ku, Tokyo 108-6290, Japan
Healthcare Business Unit, phone: +81-3-6433-3705 fax: +81-3-6433-3785

<https://www.healthcare.nikon.com/>

Industrial Metrology Business Unit, phone: +81-3-6433-3701 fax: +81-3-6433-3784
<https://industry.nikon.com/>

ISO 14001 Certified
for NIKON CORPORATION

ISO 9001 Certified
for NIKON CORPORATION
Industrial Metrology Business Unit

NIKON INSTRUMENTS INC.

1300 Walt Whitman Road, Melville, N.Y. 11747-3064, U.S.A.
phone: +1-631-547-8500; +1-800-52-NIKON (within the U.S.A. only)
fax: +1-631-547-0306

<https://www.microscope.healthcare.nikon.com/>

NIKON METROLOGY, INC.

12701 Grand River Avenue, Brighton, MI 48116 U.S.A.
phone: +1-810-220-4360 fax: +1-810-220-4300

E-mail: Sales.US-NM@nikon.com

<https://industry.nikon.com/en-us/>

NIKON EUROPE B.V.

Stroombaan 14, 1181 VX Armstelveen, The Netherlands
phone: +31-20-7099-000

https://www.microscope.healthcare.nikon.com/en_EU/

NIKON METROLOGY EUROPE NV

Interleuvenlaan 86 B-3001 Leuven, Belgium
phone: +32-16-74-01-00 fax: +32-16-74-01-03

E-mail: Sales.Europe.NM@nikon.com

<https://industry.nikon.com/en-gb/>

Nikon Precision (Shanghai) Co., Ltd.

CHINA phone: +86-21-6841-2050 fax: +86-21-6841-2060
(Beijing branch) phone: +86-10-5831-2028 fax: +86-10-5831-2026
(Guangzhou branch) phone: +86-20-3882-0550 fax: +86-20-3882-0580

NIKON INSTRUMENTS KOREA CO., LTD.

KOREA phone: +82-2-2186-8400 fax: +82-2-555-4415

NIKON SINGAPORE PTE LTD

SINGAPORE phone: +65-6559-3651 fax: +65-6559-3668

NIKON AUSTRALIA PTY LTD

AUSTRALIA phone: +61-2-8767-6900

PT. NIKON INDONESIA

INDONESIA phone: +62-267-8643949 fax: +62-267-8643950

NIKON SALES (THAILAND) CO., LTD.

THAILAND phone: +66-2633-5100 fax: 66-2633-5191

NIKON METROLOGY - MÉXICO

MEXICO phone: +52-442-688-5067

E-mail: Sales.NM-MX@nikon.com

NIKON CANADA INC.

CANADA phone: +1-905-602-9676 fax: +1-905-602-9953

NIKON INSTRUMENTS S.p.A.

ITALY phone: +39-55-300-96-01

NIKON GMBH SWITZERLAND

SWITZERLAND phone: +41-43-277-28-67

NIKON CEE GMBH

AUSTRIA phone: +43-1-972-6111

NIKON UK LTD.

UNITED KINGDOM: phone: +44-208-247-1717

NIKON METROLOGY UK LTD.

UNITED KINGDOM: phone: +44-1332-811-349 fax: +44-1332-639-881

E-mail: Sales.UK.NM@nikon.com

NIKON FRANCE S.A.S.

FRANCE phone: +33-1-4516-45-16

NIKON METROLOGY SARL

FRANCE phone: +33-1-60-86-09-76 fax: +33-1-60-86-57-35

E-mail: Sales.France.NM@nikon.com

NIKON GMBH

GERMANY phone: +49-211-941-42-20 fax: +49-211-941-43-22

NIKON METROLOGY GMBH

GERMANY phone: +49-211-45-44-69-51

E-mail: Sales.Germany.NM@nikon.com