



ATTREZZATURE PER L'AGRICOLTURA
EQUIPMENT FOR AGRICULTURE
ÉQUIPEMENTS POUR L'AGRICULTURE
AUSRÜSTUNGEN FÜR DIE LANDWIRTSCHAFT
EQUIPOS PARA AGRICULTURA
ОБОРУДОВАНИЕ ДЛЯ СЕЛЬСКОГО ХОЗЯЙСТВА

5





FORCHE E CESTE

Le forche sono attrezzature idrauliche realizzate per la movimentazione di ramaglie, fieno, paglia, letame, erba, scarti di giardinaggio, rifiuti agricoli e industriali. Sono costituite da due pale sincronizzate, azionate da uno o due cilindri, con applicati dei robusti denti in acciaio antiusura che assicurano la penetrazione e la presa del materiale. Le ceste sono utilizzate per il carico di bietole su gru da autocarro, escavatori e caricatori. Sono composte da un corpo centrale con due valve incernierate, la cui particolare forma e costruzione permettono la presa del carico escludendo terra e sassi presenti al suolo. La serie CSL è una versione specifica per movimentazione di cippato impiegata in impianti di riciclaggio e lavorazione di scarti di legno. Robustezza, affidabilità, elevate prestazioni e durata sono garantiti dall'utilizzo di acciai speciali e da un'accurata progettazione. Forche e ceste possono essere equipaggiate con rotatori idraulici.

FORKS AND BEET GRABS

The forks are hydraulically operated and specifically designed for the handling of waste wood, hay, straw, manure, grass, garden waste, agricultural waste and industrial waste. The grabs consist of two synchronized tines operated by one or two hydraulic cylinders. The grabs are fitted with heavy duty teeth manufactured from hard wearing steel to ensure long life, penetration and the holding of the materials. The beet grabs can be used by trucks, cranes, excavators and loaders. They are composed of a central body with two hinged tines whose shape and construction allow the load to be gripped while allowing earth and stones to remain on the ground. The CSL range is specially designed for the handling of wood chips used in the recycling and processing of waste wood. Robustness, reliability, high performance and durability are guaranteed by the use of special steels and successful design. Forks and beet grabs can be fitted with hydraulic rotators.

FOURCHES ET BENNES À BETTERAVES

Les fourches sont des équipements hydrauliques réalisés pour le traitement des déchets du bois, du foin, de la paille, du fumier, de l'herbe, des déchets de jardin, des déchets agricoles et industriels. Elles sont constituées de deux coquilles synchronisées, actionnées par un ou deux vérins, avec des dents robustes en acier anti-usure qui assurent la pénétration et la prise des matériaux. Les bennes à betteraves sont utilisées pour le chargement de betteraves sur les camions-grues, et les pelles. Elles sont composées d'un corps central avec deux coquilles articulées, dont la forme et la construction particulière permettent la préhension de la charge en excluant la terre et les pierres présentes sur le terrain. La série CSL est une version spécifique pour le traitement des copeaux de bois, utilisée dans les installations de recyclage et de traitement des déchets du bois. Robustesse, fiabilité, hautes performances et durabilité sont garanties par l'utilisation d'aciers spéciaux et par une réalisation minutieuse. Les fourches et les bennes peuvent être équipées avec un rotator hydraulique.

GABELN UND GREIFERKÖRBE



Gabeln sind hydraulische Ausrüstungen für den Umschlag von Reisig, Heu, Mist, Gartenabfällen sowie Landwirtschafts- und Industrieabfällen. Sie bestehen aus 2 sich synchron bewegenden Schalen mit einem oder zwei Zylindern und aus verschleißfesten robusten Stahlzähnen, die ein optimales Eindringen und Aufnahme des Materials gewährleisten. Die Greiferschalen werden für das Beladen von Rüben mit Ladekränen, Baggern und Ladern eingesetzt. Sie bestehen aus einem Grundkörper mit 2 gelenkigen Schalen. Die Form und die Konstruktion der Schalen ermöglichen den Umschlag der Ladung, ohne unnötiges Material wie Erde oder Steine aufzunehmen. Die Serie CSL ist eine spezielle Ausführung für den Umschlag von Holzspänen, die vor allem in Recyclinganlagen und in Verarbeitungsanlagen für Holzabfälle eingesetzt wird. Durch den Einsatz von Spezialstahltypen, verbunden mit einer gewissenhaften Projektierung sind Stabilität, Zuverlässigkeit, Langlebigkeit und eine hohe Leistungsfähigkeit gewährleistet. Die Gabeln und die Greiferkörbe können mit hydraulischen Drehmotoren ausgestattet werden.



HORQUILLAS Y CESTAS

Las horquillas son equipos hidráulicos que sirven para mover ramas, pajas, hierbas, residuos agrícolas e industriales. Se encuentran dos palas juntas accionadas por uno o dos cilindros. Dichas palas están incorporan dientes de gran dureza para garantizar la penetración y recogida de los materiales. Las cestas se usan para la carga de acelgas sobre camiones grúa, excavadoras y cargadores. Están compuestas de una carrocería central con dos valvas insertadas, por su forma y construcción permiten la carga de rocas sin necesidad de recoger arenas o otros tipos de tierra. La serie CSL es una versión diseñada para mover pequeñas cargas de madera usada en plantas de reciclaje y la elaboración de retales de madera. Robustez, confianza, óptimas prestaciones y longevidad están garantizadas gracias a la utilización de aceros especiales y una disposición de los elementos muy cuidadosa. Nuestras horquillas y cestas son aptas para incorporar rotores hidráulicos.

ВИЛОЧНЫЕ ЗАХВАТЫ И ГРЕЙФЕРЫ ДЛЯ СЕЛЬСКОХОЗЯЙСТВЕННЫХ РАБОТ

Гидравлически управляемые вилочные захваты предназначены для перевалки стружки, сена, соломы, удобрений, травы, отходов садоводства, сельскохозяйственного мусора и промышленных отходов. Грейфер состоит из двух синхронных лепестков, управляемых одним или двумя гидроцилиндрами. Грейферы оборудованы двумя прочными зубьями, изготовленными из износостойкой стали для долговременной службы, заглубления и удержания материала. Сельскохозяйственные грейферы используются на грузовиках, кранах, экскаваторах и погрузчиках. Они состоят из центрального корпуса с двумя челюстями на шарнирах, форма и конструкция позволяет захватывать основной груз, оставляя камни и землю. Серия CSL специально предназначена для перевалки стружки, которая используется при вторичной обработке и переработке лесоматериалов. Надежность, точное исполнение и продолжительный срок службы гарантированы при использовании специальных сталей и мастерского дизайна. Вилочные захваты и грейферы могут быть оборудованы гидравлическим ротатором.

 Esempi di applicazione
 Examples of application
 Exemples d'application

 Anwendungsbeispiele
 Ejemplos de aplicacion
 Примеры комплектации

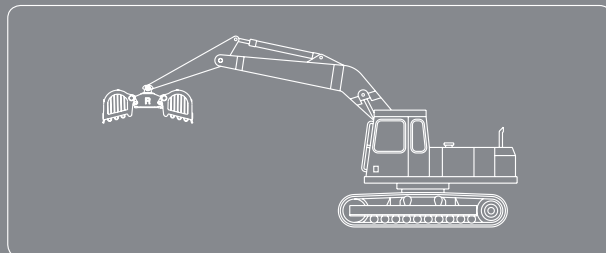
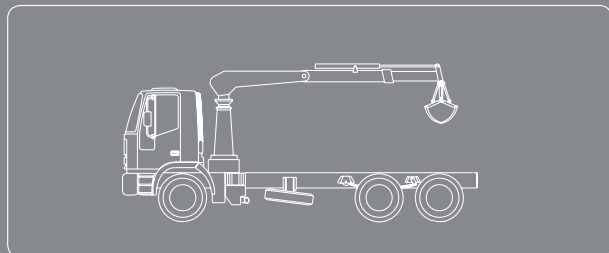

braccio gru
crane boom

braccio escavatore
excavator boom



R9

R7

rotatore idraulico
hydraulic rotator

rotatore idraulico
hydraulic rotator

braccio gru
crane boom

braccio escavatore
excavator boom

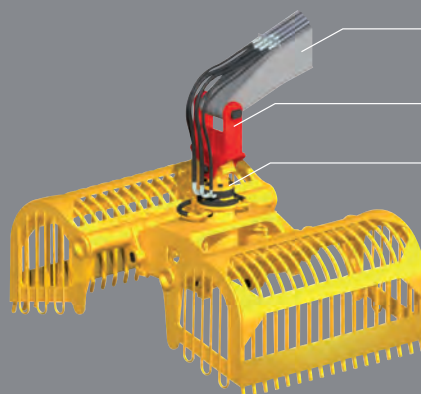







R9

R7



rotatore idraulico
hydraulic rotator

rotatore idraulico
hydraulic rotator

 Schemi utilizzo per forche e ceste
 Scheme of use for forks and grabs
 Schéma d'emploi pour fourches et bennes

 Anwendungsübersicht für Gabeln und Greiferkörbe
 Esquema de uso para horquillas y cestas
 Схема использования вилочных захватов и грейферов



Forche e ceste Forks and grabs	Gancio Hook	Rotatore idraulico Hydraulic rotator	Peso escavatore / caricatore Excavator / loader weight
R69	R9	R102	1.5 - 2.5
R41/145F - 155F	R9	R102 - R103	2 - 3
R70 - R71	R9	R103 - R104	2 - 6
R74FR75 - R74FR100	R9	R104 - R105 - R105H	5 - 10
R175	R7 - R7R	R105H - R3IR - R1G	9 - 16
R176	R7 - R7R	R3IR - R3BIR - R1G - R4G	15 - 25
R10 - 12	R9	R104 - R105	4 - 9
R12,5	R7	R105H - R1G	9 - 15
R13/1500 - 1700 - 2000	R7 - R7R	R3IR - R3BIR - R4G	13 - 20
R13/2250 - 2600 - 3000	R7R	R3BIR - R4G	18 - 25

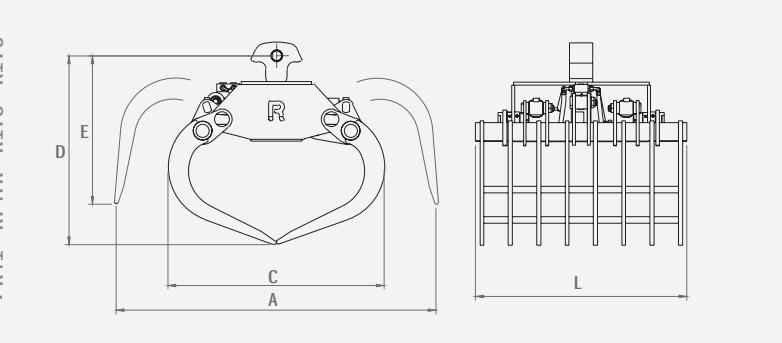
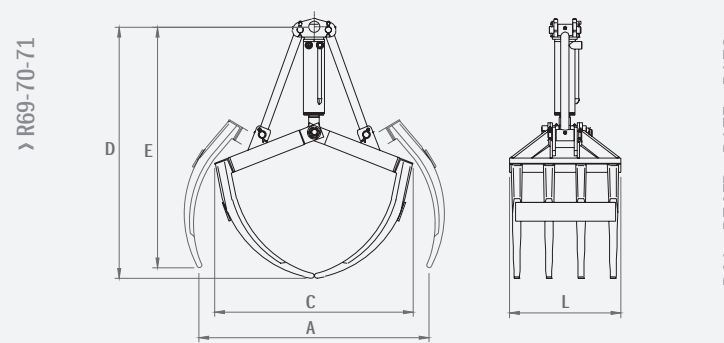

 Forche per la movimentazione letame e materiali diversi
 Forks for manure's and different materials' handling
 Fourches pour la manipulation du fumier et de matériaux divers

 Gabeln für Mist - und verschiedenen Materialumschlag
 Horcas para estiércol y materiales diversos
 Вилочный грейфер для органических отходов и других материалов



Modello	Peso	Pressione	Portata olio	Numero denti	Dimensioni				
Model	Weight	Pressure	Oil flow	Teeth number	Sizes				
Modèle	Poids	Pression	Débit d'huile	Dents nombre	Dimensions				
Modell	Gewicht	Druck	Ölleistung	Zähne Stück	Abmessungen				
	kg	bar	l/min	N.	A	C	D	E	L
R41/145A F	95	280	20	8	1010	770	630	500	400
R41/155A F	100	280	20	10	1010	770	630	500	600
R69	70	260	30	8	900	790	965	900	450
R70	150	260	60	10	1040	950	1140	1090	600
R71	190	260	60	14	1040	950	1140	1090	930
R74 FR75	300	300	70	9	1470	820	1020	870	720
R74 FR100	350	300	70	13	1470	820	1020	870	1040
R 175	440	280	80	16	1640	1100	960	760	1080
R176	1050	280	90	18	2210	1430	1290	980	1100

 Ceste per movimentazione bietole e materiali diversi
 Grabs for beets' and different materials' handling
 Bennes pour la manipulation de betteraves et de matériaux divers

 Greifer für Rüben - und verschiedenen Materialumschlag
 Cestas para remolacha y materiales diversos
 Грейфер для погрузки овощей

> R10



> R12.5 > R13

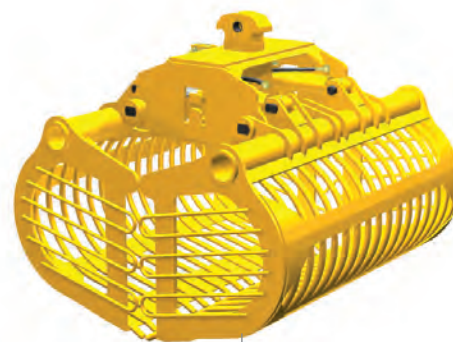

> R12



> R12.5 > R13



> R10-12

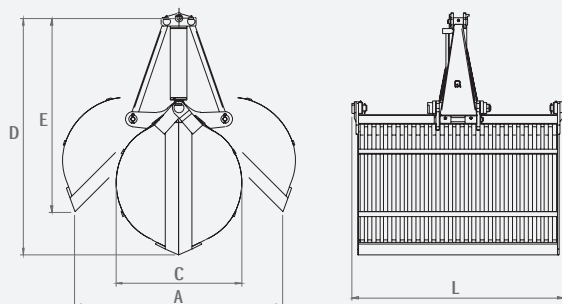

> R12.5-R13

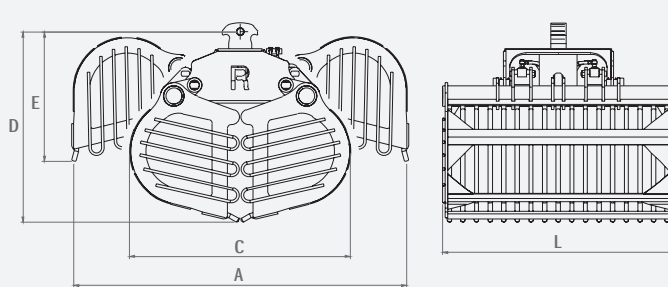

Modello	Peso	Capacità	Pressione	Portata olio	Dimensioni				
Model	Weight	Capacity	Pressure	Oil flow	Sizes				
Modèle	Poids	Capacité	Pression	Débit d'huile	Dimensions				
Modell	Gewicht	Inhalt	Druck	Ölleistung	Abmessungen				
	kg	dm ³	bar	l/min	A	C	D	E	L
R10	320	500	200	60	1460	760	1430	1330	1250
R12	250	500	200	60	1460	760	1430	1330	1250
R12.5	500	800	250	40	1850	1210	1060	780	1500
R13/1500	930	1200	250	90	2450	1300	1400	1000	1480
R13/1700	960	1350	250	90	2450	1300	1400	1000	1680
R13/2000	1300	2000	250	90	2620	1730	1510	1030	1600
R13/2250	1450	2250	250	90	2620	1730	1510	1030	1820
R13/2600	1600	2600	250	90	2620	1730	1510	1030	2150
R13/3000	1700	3000	250	90	2620	1730	1510	1030	2460