

Notice de montage

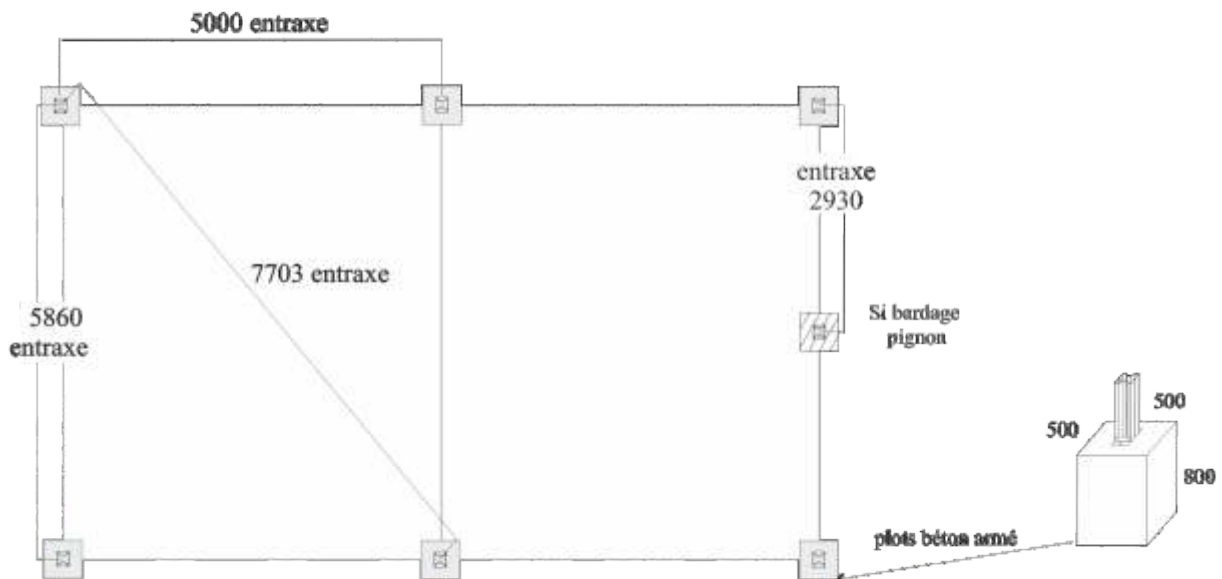

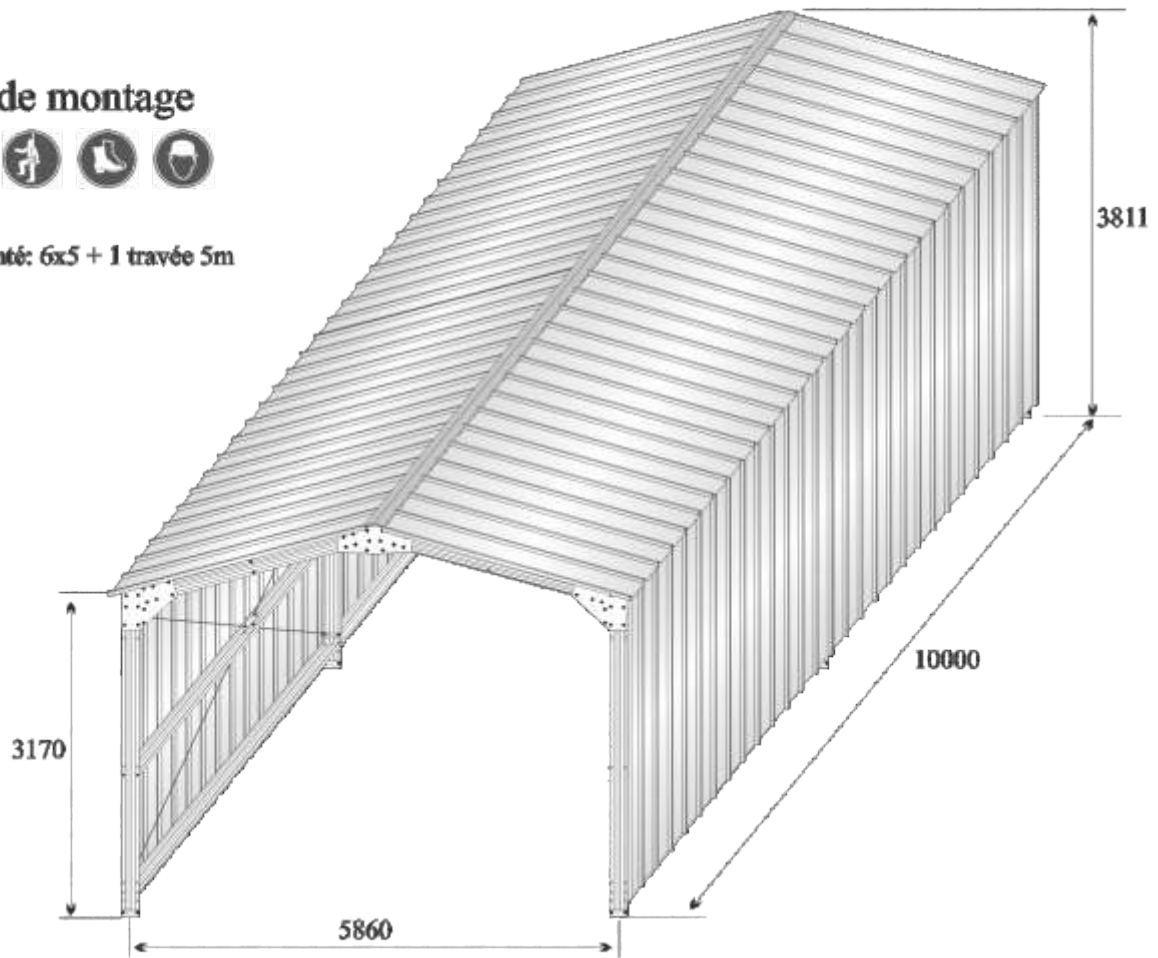

Modèle présenté: 6x5 + 1 travée 5m

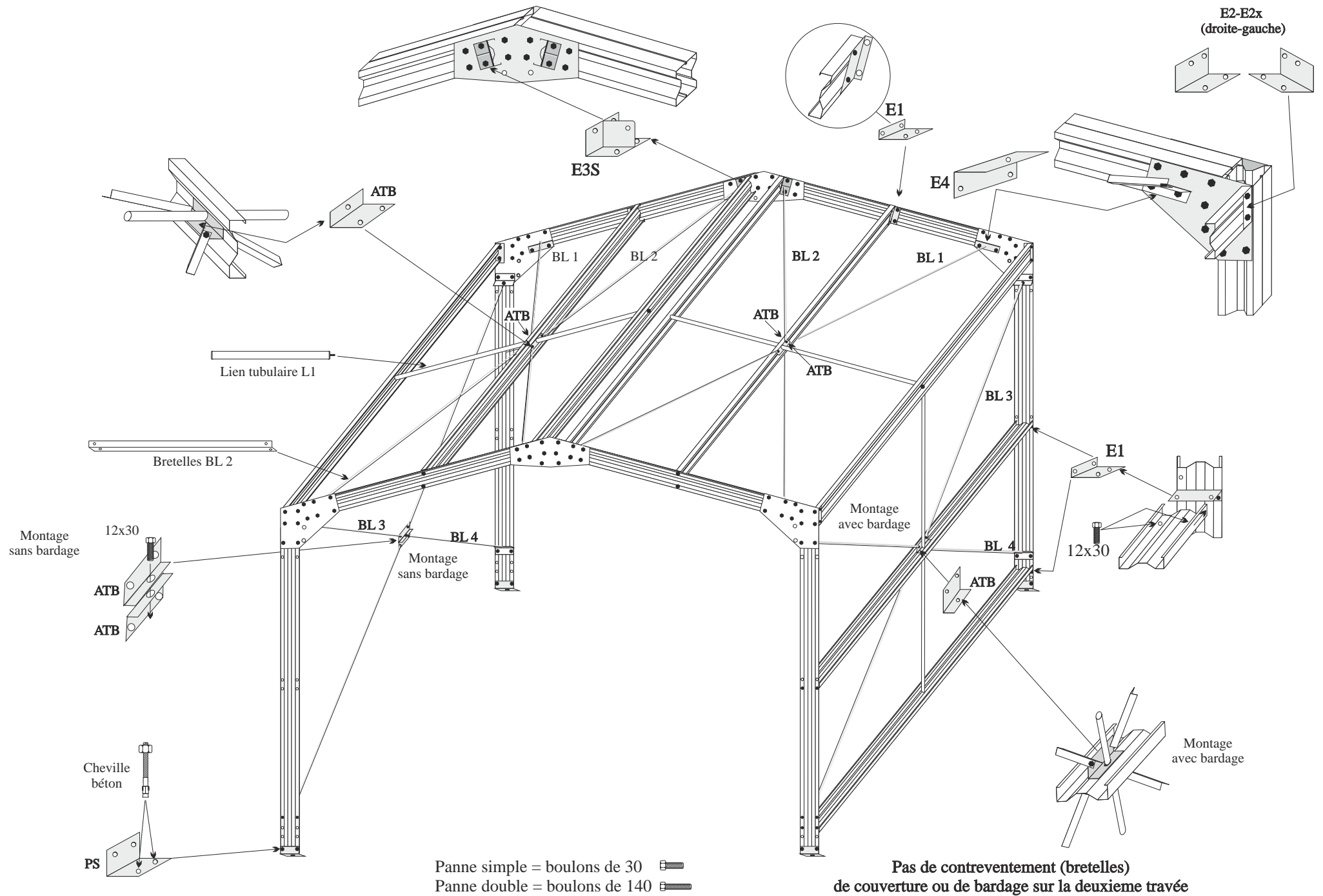

Si un portail doit être installé sur le pignon ou le long pan, prévoir une longrine de 300/200 sur une longueur de 2 fois le vantail

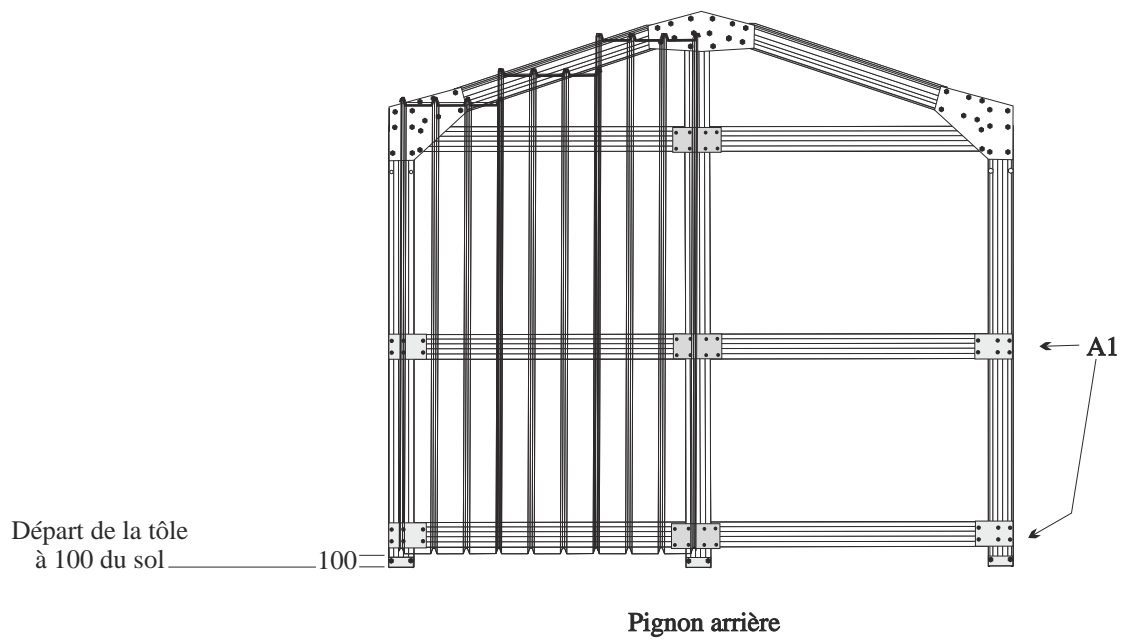
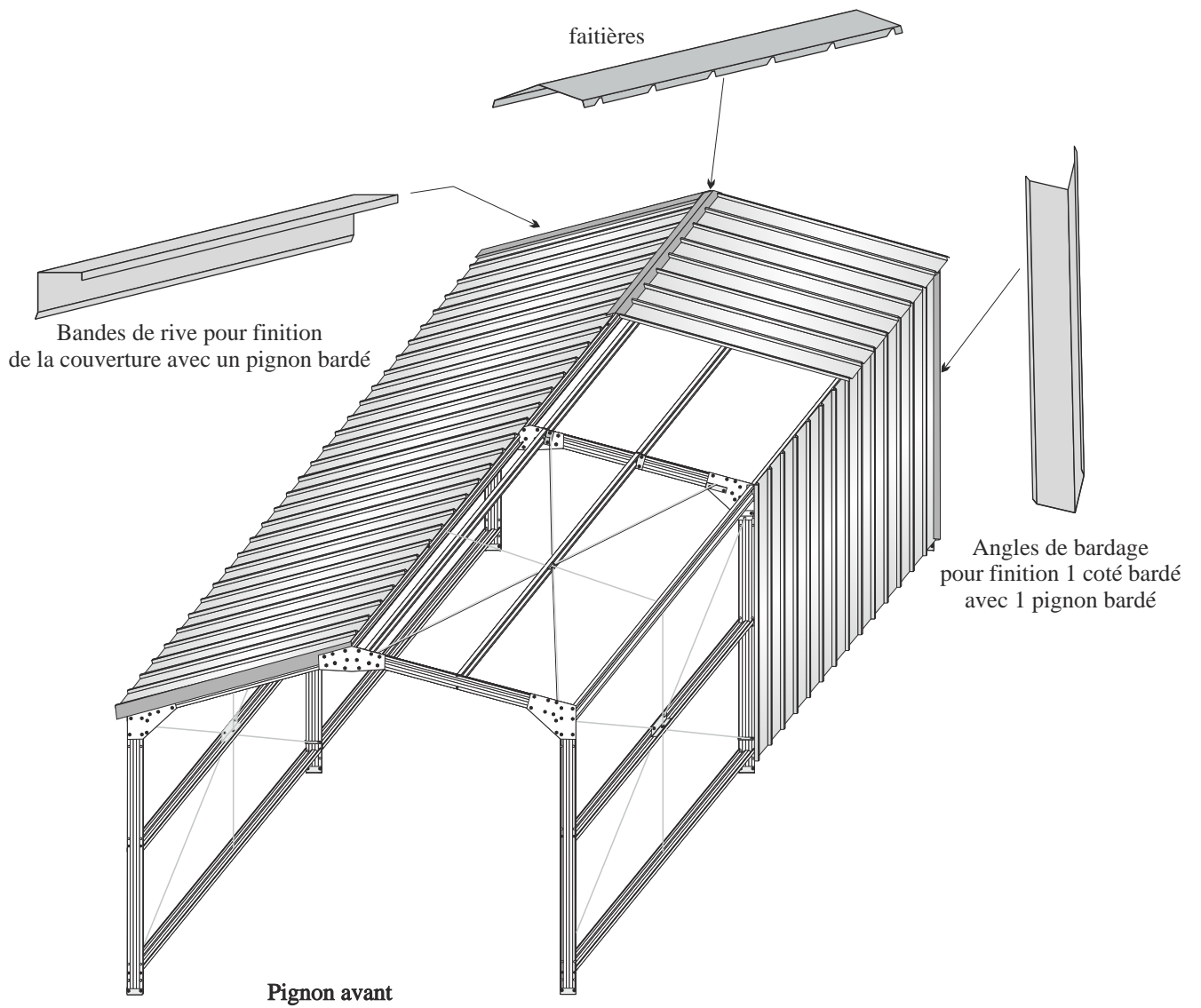



Panne simple = boulons de 30 
 Panne double = boulons de 140 

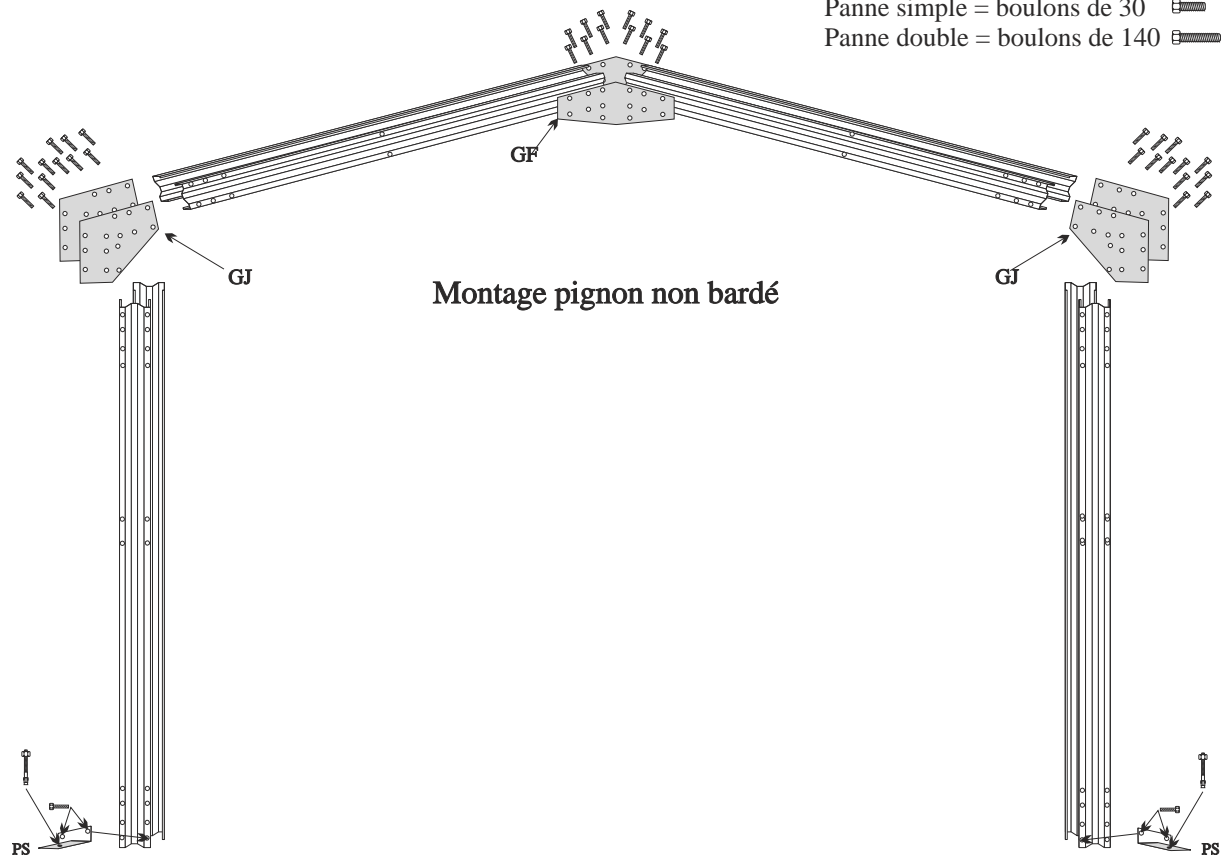

Montage pignon non bardé

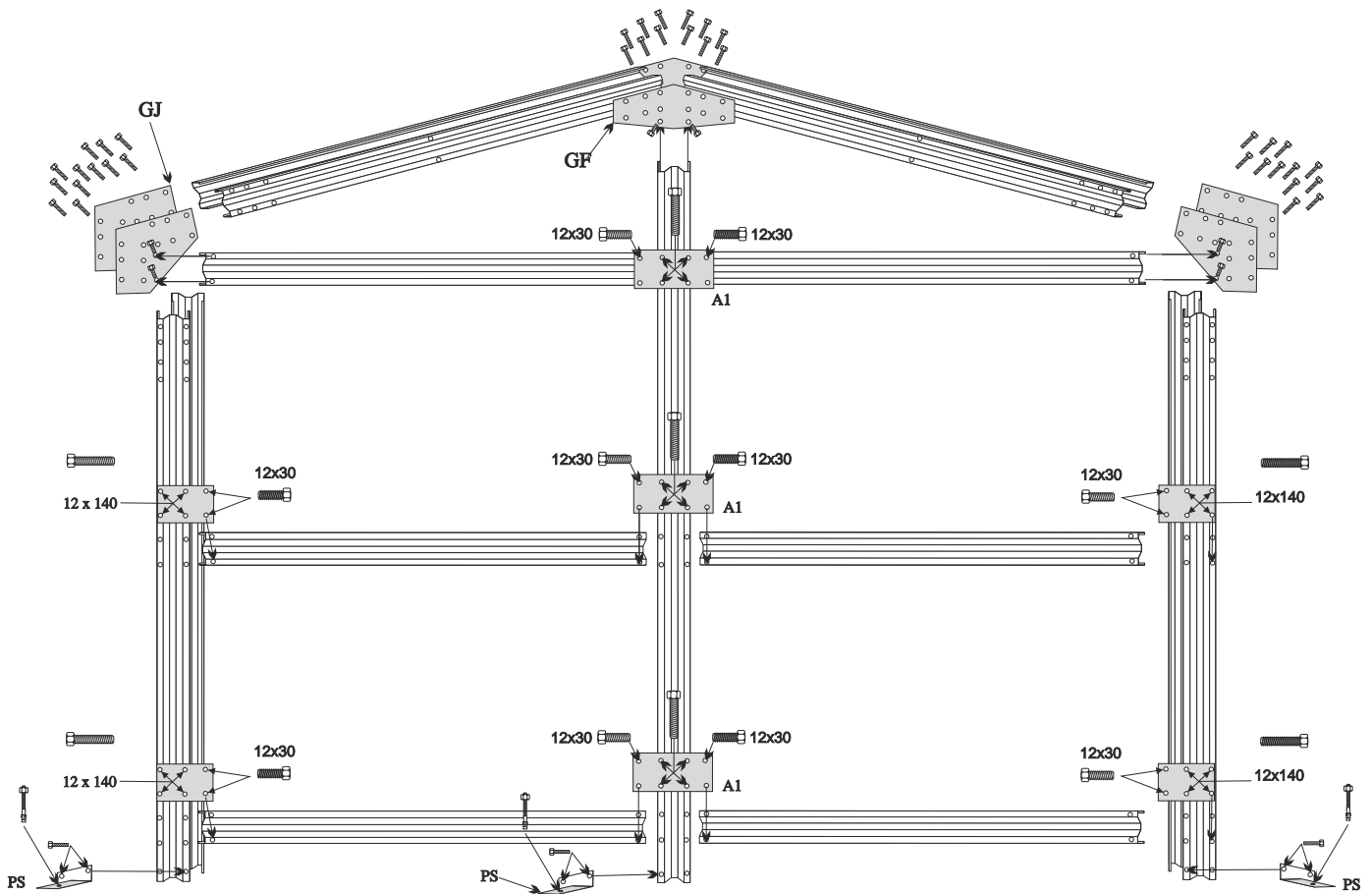

Montage ferme avec option ossature pignon