

Ogi M

descriptif technique

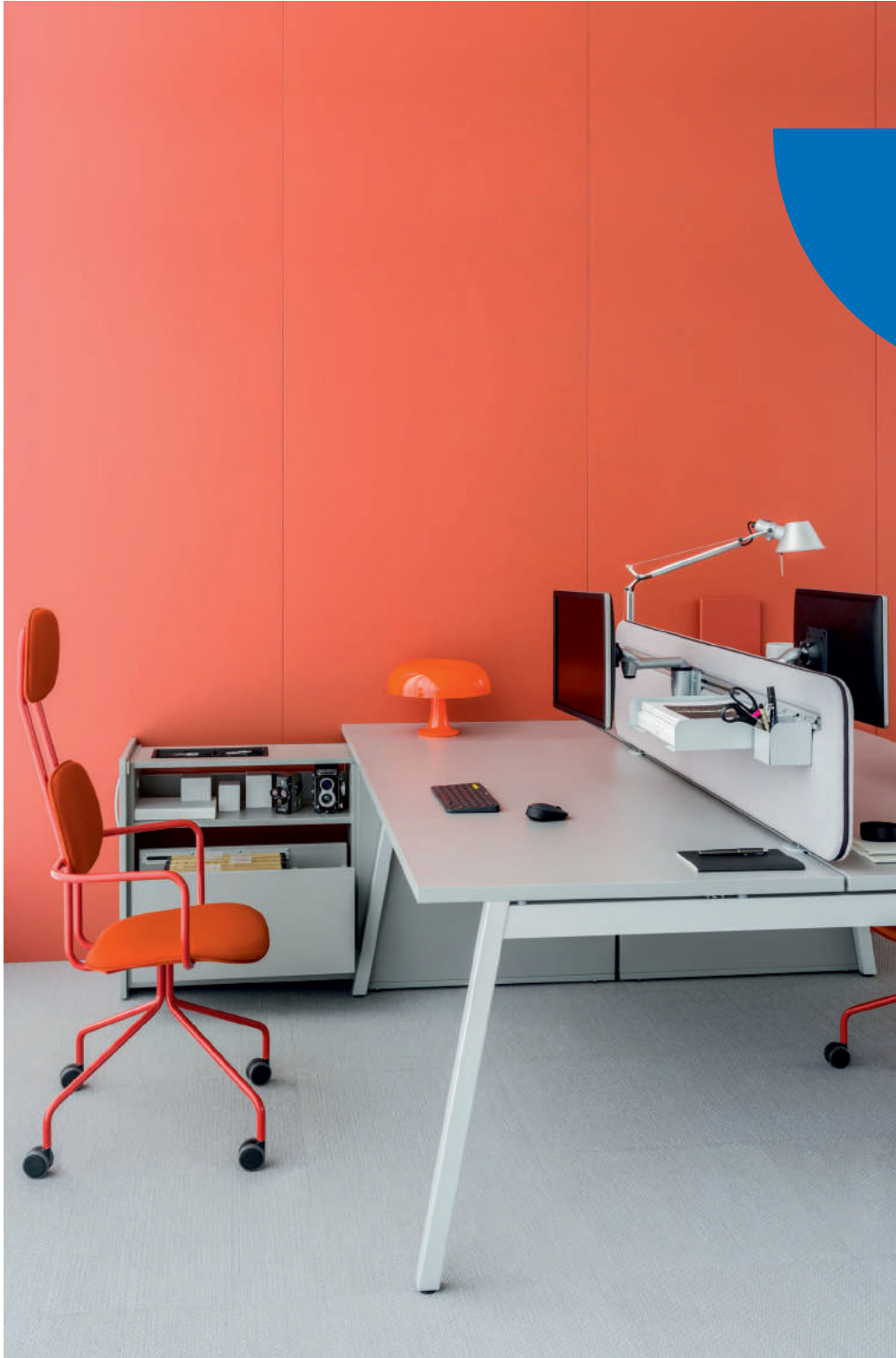

.mdd

MDD, créée en 1993 à Sępólno Krajeńskie en Pologne, est d'abord une histoire d'amitié entre Jaroslaw DABROWSKI et Zbigniew MATTYA.

Depuis l'origine, nous souhaitons incarner un modèle d'entreprise où l'humain est la première des préoccupations. Nous considérons que l'épanouissement personnel de chaque membre de notre équipe, est la clé de notre succès. Garder comme piliers des valeurs familiales participe à ce projet.

Nous créons du mobilier répondant aux besoins spécifiques des espaces de travail. Pour vous permettre de favoriser le travail collaboratif, la créativité et les échanges dans l'entreprise, nous vous proposons un mobilier design, conçu PAR et POUR l'homme. Grâce à notre politique de réinvestissement constant dans l'outil de production nous disposons d'un parc de machines modernes, permettant une fabrication de qualité. Citoyens du monde, nous agissons aujourd'hui en pensant aux générations de demain. Ainsi nous utilisons des matériaux au taux de recyclabilité proche de 95%.

Le monde du travail est en mutation constante. Nous veillons, et collaborons avec des designers et nos clients, pour anticiper et être toujours au plus près du besoin.



Informations générales :

Garantie :

Produits MDD - **5 ans**.

Composants électriques et tissus - **2 ans**.

Mélangé - certifié :



Montage :

livrée en pièces détachées

Emballage:

carton, enveloppe en plastique perforé

Conforme aux normes :

PN-EN 527-2:2017-02

Densité du panneau :

12 mm - 690 - 750 kg/m³

18 mm - 650 - 690 kg/m³

28 mm - 610 - 630 kg/m³

36 mm - 610 - 630 kg/m³

Plateaux bureaux Ogi

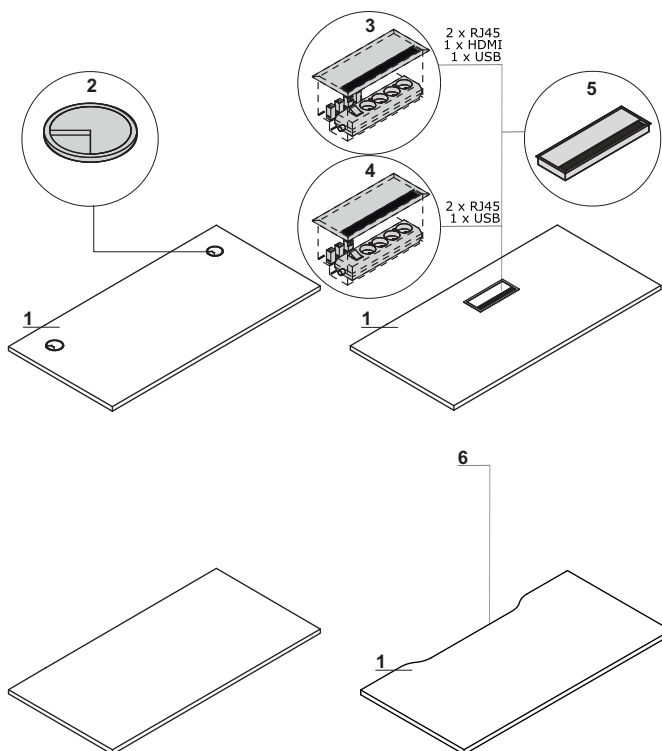

- 1. Plateau - mélaminé 28 mm, chants ABS
- OPTION PAYANTE:
- 2. Obturateurs - 2 pcs, Ø 80 mm
- 3. Mediabox M04H - 2xRJ45 (classe E, cat. 6); 1xUSB/1xHDMI/4x230V, couleur: M009 - aluminium semi-mate
- 4. Mediabox M04 - 2xRJ45 (classe E, cat. 6); + 1 x USB + 4 x 230V, couleur: M009 - aluminium semi-mate
- 5. Top access M05 - couleur: M009 - aluminium semi-mate
- 6. Passage de câbles - la largeur de l'ouverture est proportionnelle à la largeur du plan de travail

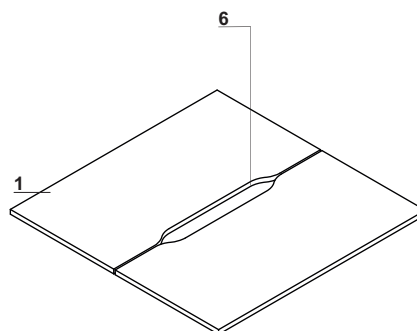

Dimensions du plateau avec découpe pour passage câbles (mm)

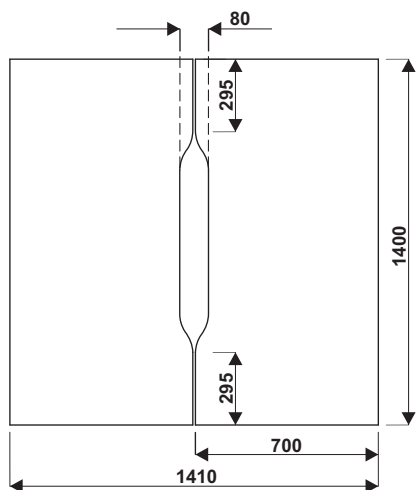

Piétement

Ogi M: métal finition peinture poudre époxy, profil 40 × 40 mm, distance entre le dessus et le cadre de 10 mm

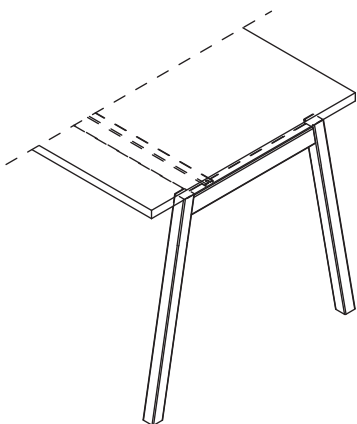

Bureaux manager sur meuble retour porteur

- 1. **Plateau** - mélaminé 28 mm, chants ABS
- 2. **Top** - mélaminé 28 mm, chants ABS
- 3. **Tablette** - mélaminé 18 mm, protection contre les chutes accidentelles, chants ABS
- 4. **Tiroir** - mélaminé 18 mm; chants ABS, serrure, possibilité de le changer de place
- 5. **Base** - mélaminé 18 mm, chants ABS
- 6. **Façade** - mélaminé 18 mm, chants ABS

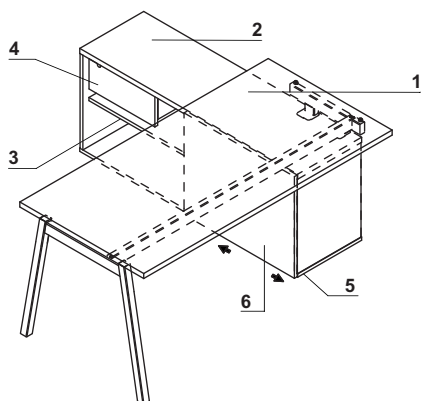

www.mdd.eu

Exemples de configurations (mm)

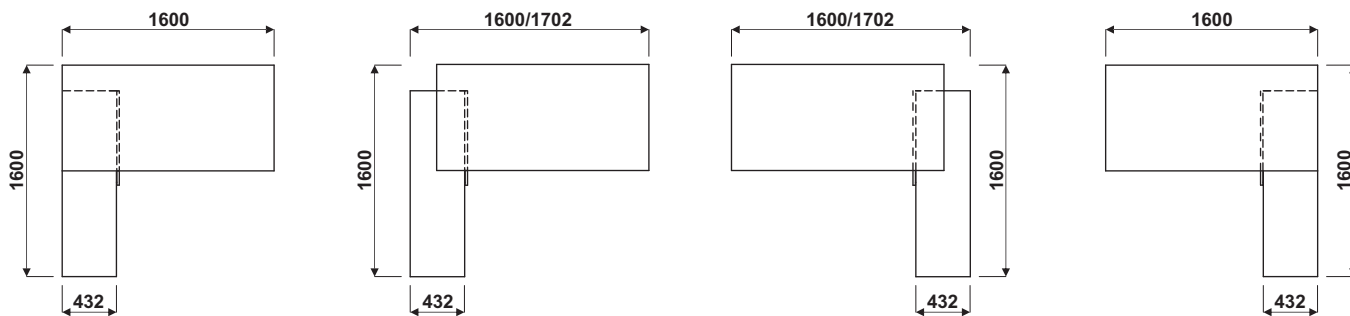

Exemples de configurations (mm)

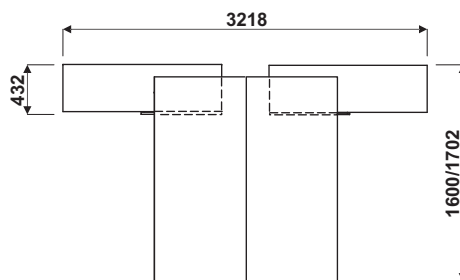
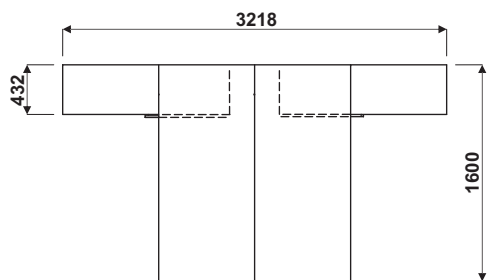

Exemples de configuration avec BOX40, BOX50, BOX60

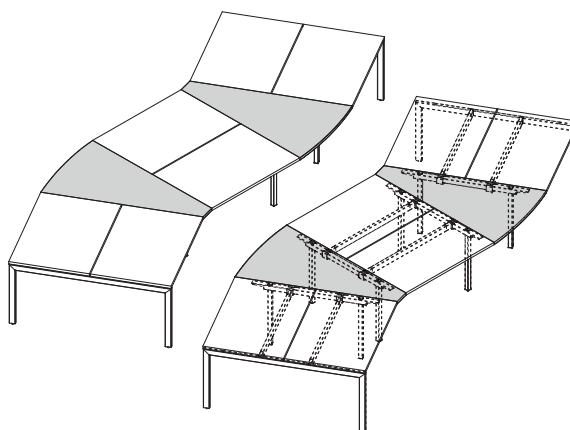
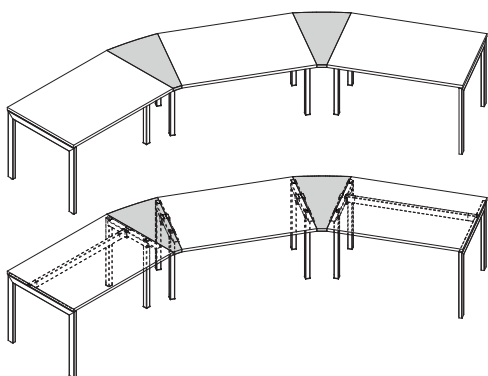

REMARQUE – Uniquement pour les systèmes Ogi Q, Ogi U, Ogi Y, Ogi W, Ogi M

Accessoires

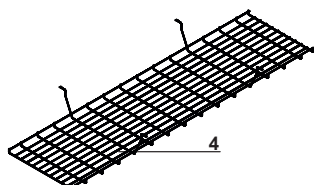
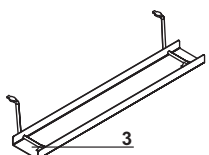
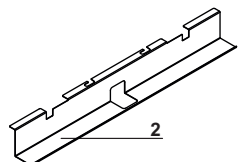
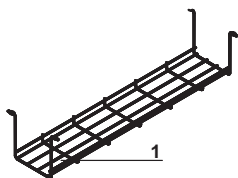

1. **Chemin de câbles S69** - métal finition peinture poudre époxy, couleur 09 - aluminium
2. **Chemin de câbles (SG2, SG16)** - pour bureau individuel, métal finition peinture poudre époxy, couleur M009 - aluminium semi-mate
3. **Chemin de câbles E64** - métal finition peinture poudre époxy, couleur M009 - aluminium semi-mate
4. **Chemin de câbles pour bench Ogi (SG220, SG260)** - fil acier Ø4 mm, métal finition peinture poudre époxy, couleur : 09 - aluminium

Bureaux droits



BOM22
1200 / 700 / 740
29.9 kg



BOM24
1400 / 700 / 740
33.3 kg



BOM26
1600 / 700 / 740
36.9 kg

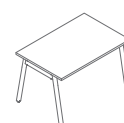

BOM02
1200 / 800 / 740
35.8 kg



BOM03
1400 / 800 / 740
36.3 kg



BOM04
1600 / 800 / 740
36.9 kg



BOM05
1800 / 800 / 740
40 kg



BOM06
2000 / 800 / 740
46.3kg

Élément suivant - pour bureau droit



BOX40
500 / 800 / 740
10.8 kg

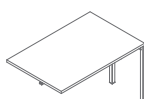

BOX42
1200 / 800 / 740
31.6 kg

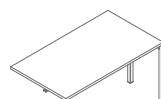

BOX43
1400 / 800 / 740
32.1 kg

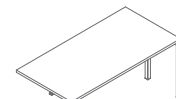

BOX44
1600 / 800 / 740
32.7 kg

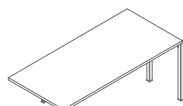

BOX45
1600 / 800 / 740
35.8 kg

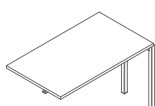

BOX32
1200 / 700 / 740
26.3 kg

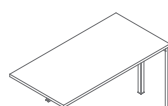

BOX34
1400 / 700 / 740
29.7 kg

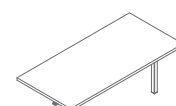

BOX36
1600 / 700 / 740
33.3 kg

Benchs

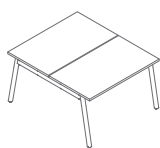

BOM42
1200 / 1410 / 740
54.8 kg

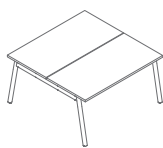

BOM44
1400 / 1410 / 740
61.6 kg

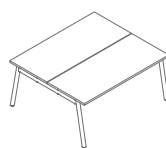

BOM46
1600 / 1410 / 740
68.8 kg



BOM32
1200 / 1610 / 740
65.6 kg

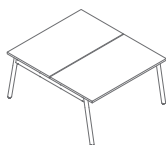

BOM33
1400 / 1610 / 740
66.6 kg

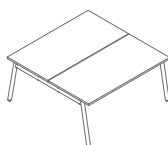

BOM34
1600 / 1610 / 740
67.8 kg

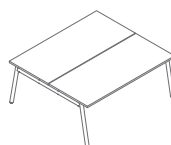

BOM35
1800 / 1610 / 740
74 kg

Élément de jonction et élément suivant - pour bench

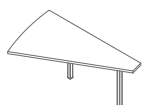

BOX50
1000 / 1410 / 740
16.5 kg

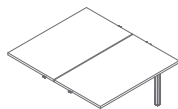

BOX52
1200 / 1410 / 740
49.4 kg

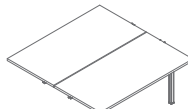

BOX54
1400 / 1410 / 740
56.2 kg

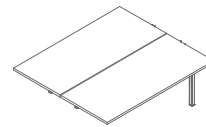

BOX56
1600 / 1410 / 740
63.4 kg

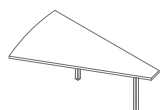

BOX60
1000 / 1610 / 740
17.5 kg

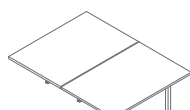

BOX62
1200 / 1610 / 740
60.1 kg

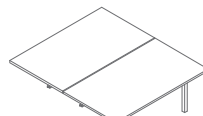

BOX64
1400 / 1610 / 740
61.1 kg

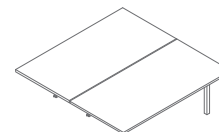

BOX66
1600 / 1610 / 740
62.3 kg

Élément de jonction et élément suivant - pour bench

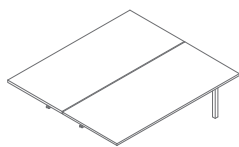

BOX68
1800 / 1610 / 740
68,5 kg

Bureaux sur meuble retour porteur

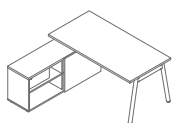

BOM20
1702-1600 / 1600 / 740
93 kg

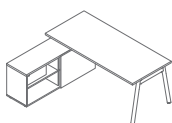

BOM21
1902-1800 / 1600 / 740
94,5 kg

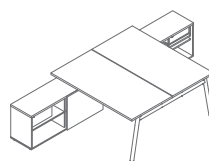

BOM40
1702-1600 / 3210 / 740
179,8 kg

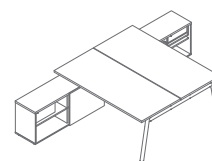

BOM41
1902-1800 / 3210 / 740
186 kg

Retours / extensions

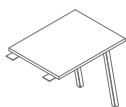

POM01
600 / 800 / 740
13,9 kg

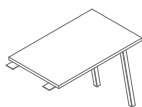

POM02
600 / 1000 / 740
15,4 kg

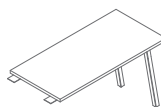

POM03
600 / 1200 / 740
17,9 kg

Plateau, top, base, corps, façade

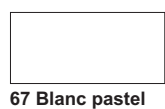

Passes câbles

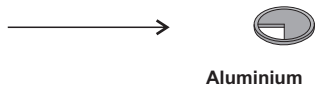

Aluminium

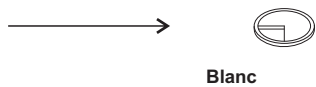

Blanc

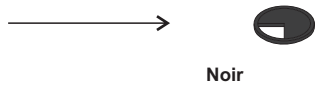

Noir

Piètement - métal

