

On-Line Total Organic Carbon Analyzer

TOC-4200



TOC-4200

Total Organic Carbon Analyzer



Highly Advanced On-Line TOC Analyzer Excels in a Wide Range of Applications



Support for a Wide Range of Samples

- Select a sampling unit to match the sample characteristics.
- Wide measurement range from 5 mgC/L full-scale to 20,000 mgC/L full-scale
Dilution function incorporated as standard.
Supports up to 50x dilution.
- High sensitivity measurements from 0 to 1 mgC/L (optional)
- Diverse TOC measurements (NPOC, TC-IC*, NPOC + POC* measurements), TN measurements*
*Optional
- Permits making a multi-point calibration curve from a single standard.

Diverse Applications

- Wastewater treatment plant influent (upstream monitoring) and effluent
- Plant water (washing water, cooling water, recovered water, etc.)
- Boiler water, condensate
- Water and sewage (raw water, treated water), advanced treated wastewater
- Total pollutant load control regulation applications (organic pollution load)

Advanced Operability

- Color LCD touch screen
- Supports data-storage devices. Easy to store measured values or measurement conditions to USB memory
- Calendar scheduling setup
- Compatible with digital bus standard
- Web-based monitoring (optional)
It allows browsing of measured values with a Web browser by network.

Support for a Wide Range of Samples

The most important demand for on-line TOC analyzers is stable operation.

The TOC-4200 incorporates Shimadzu's accumulated technical expertise to provide stable operation across all scenarios from pure water to heavily polluted water.

■ Range of sampling units to match a sample's characteristics

- Sampling units are available for applications from pure water to heavily polluted water.
- Reduces instrument maintenance frequency.
- Switch between measurement points for up to six flow lines. More economical since the need for multiple instruments is eliminated

■ Measurement ranges from 5 mgC/L full-scale to 20,000 mgC/L full-scale

An option can be attached to support high sensitivity measurements to 1 mgC/L full-scale. **TC** **NPOC**

- TOC measurement by acidify and sparge TOC also know as non-purgeable organic carbon (NPOC) **NPOC**
- TOC determination by difference between total carbon (TC) and inorganic carbon (IC)
 $TOC = TC - IC$ (requires option) **TC** **IC**
- TOC determination by addition method of NPOC and purgeable organic carbon (POC)
 $TOC = NPOC + POC$ (requires option) **NPOC** **POC**
- Support for 1 mgC/L full-scale high sensitivity measurements (optional) **TC** **NPOC**
- Dilution function installed as standard. Supports up to 50x dilution.

■ Permits making a multi-point calibration curve from a single standard.

- Standard solutions for each calibration point can be made from a single solution by using dilution function.

■ TN measurement option

Adding the TN measurement option permits total nitrogen (TN) measurements (catalytic thermal decomposition – chemiluminescence detection). **TN**

Permits measurements from 1 mgN/L full-scale to 10,000 mgN/L full-scale.

■ Reliable sample injection system

- A single unit performs sample intake, discharge, dilution and injection.
- Automated sample acidification and sparging.
- Highly reliable ceramic 8-port valve used to switch flow lines

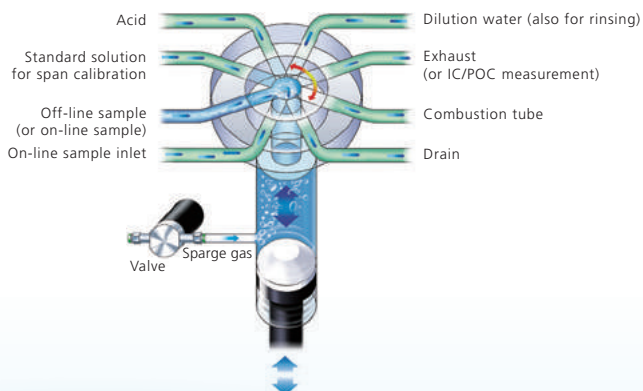

Flow Line Diagrams

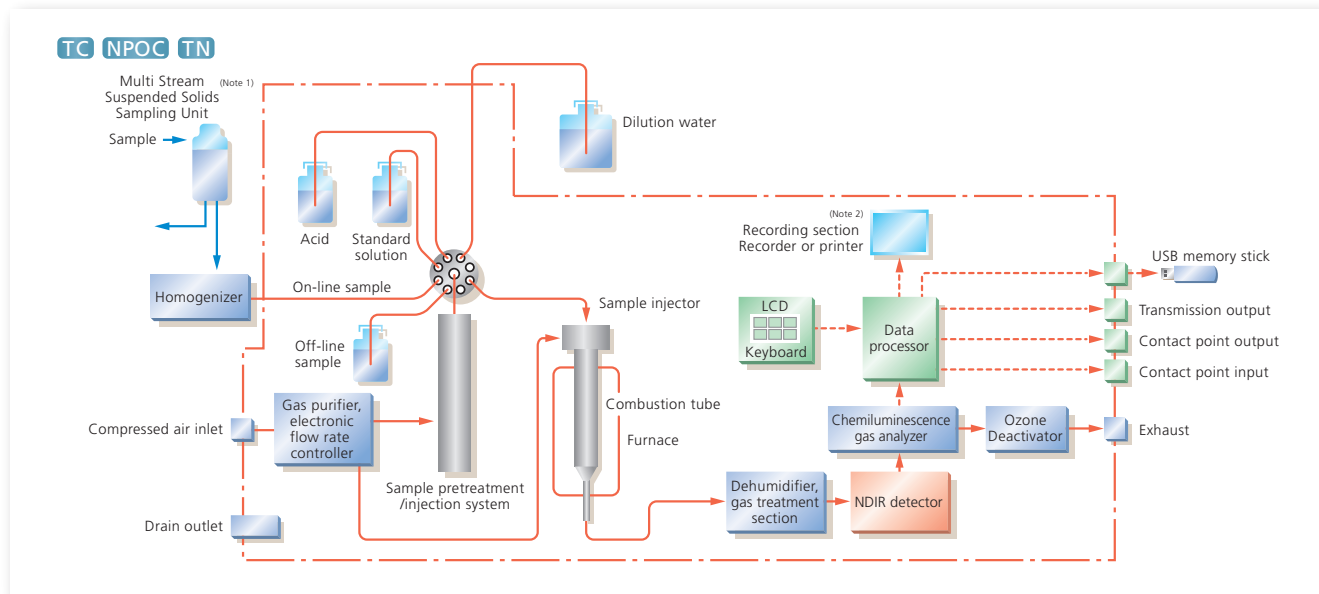
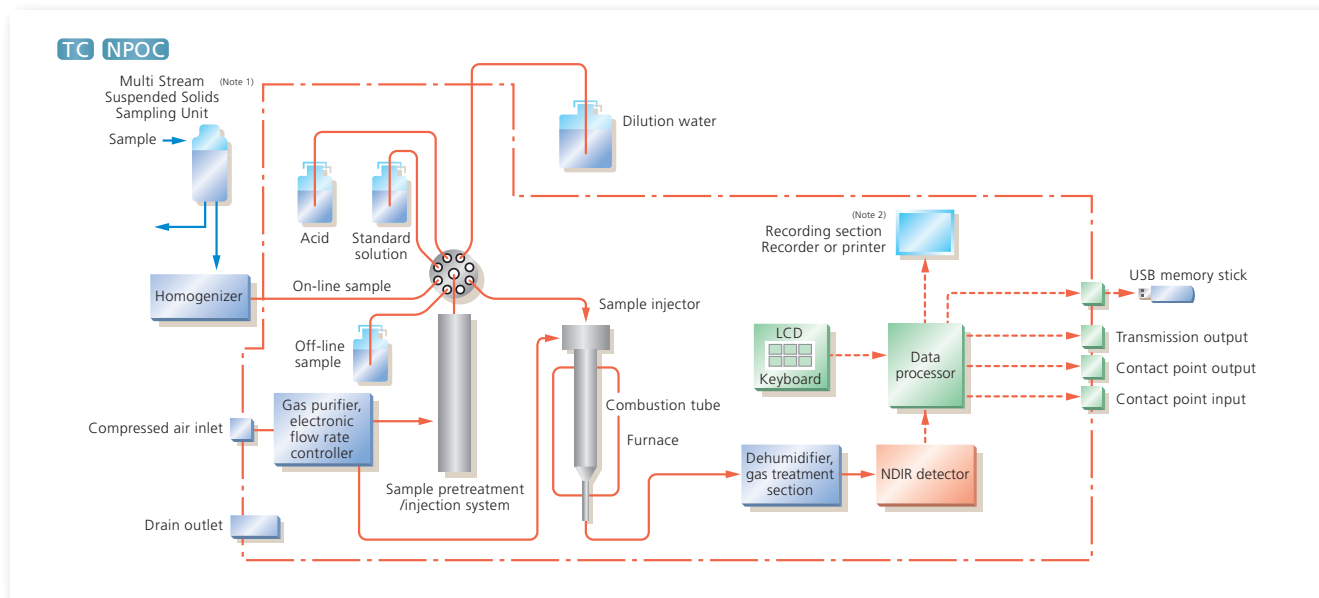

Note 1) For the sampling section, select the multi-stream suspended solids sampling unit, the single stream suspended solids sampling unit, the backwash strainer sampling unit or the sample stream kit (option).

Note 2) For the recording section, select either the recorder or the printer (options).

Diverse Applications

Measurement speed is the key feature of combustion catalytic oxidation TOC analyzers. This characteristic can be exploited to support a diverse range of applications.

■ Wastewater treatment plant influent (upstream monitoring) and effluent

- Measurements at a short measuring cycle (4 minutes minimum) rapidly capture dramatic changes in organic matter or abnormal effluent.
- The powerful oxidation capacity of a combustion-type analyzer can detect organic matter that cannot be captured using a UV meter.
- The short measuring cycle and powerful oxidation, combined with switching between up to six flow lines, offer detailed monitoring of treatment plants.

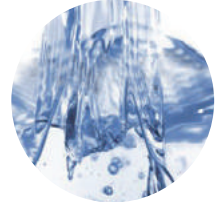

■ Monitoring of river water sampled at water purification plants and treated water (tap water)

- Monitoring changes in river water quality due to rainfall and other factors to provide control indicators for the treatment processes
- Permits simultaneous monitoring of treated tap water.

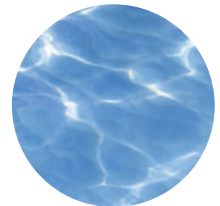

■ Supports monitoring TOC removal rate based on EPA Regulations.

- Calculates TOC removal rate based on the U.S.A EPA regulations (Part IV 40 CFR Part 9, 141 and 142, 1998). (*1)

■ Total pollutant load control regulation applications (organic pollution load)

- Converting the measured TOC values allows applications to COD total volume control. (*2)
TOC → COD conversion functions are installed as standard.
- Reading flow rate signals from a flow meter (*1) permits COD load conversion calculations.

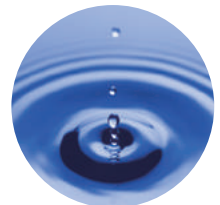

■ Plant water

(washing water, cooling water, recovered water, boiler water, condensate, etc.)

- Continuous monitoring of water used in a plant
- Continuous monitoring of pure boiler water assists in the detection of anomalies, such as damaged pipes.
- The short measuring cycle (4 minutes minimum) of the combustion-type TOC analyzer achieves more rapid detection of anomalies.

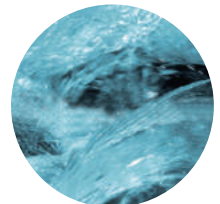

*1 Optional

*2 The TOC-COD conversion formula must be determined separately.

Example of Installation for Upstream Monitoring

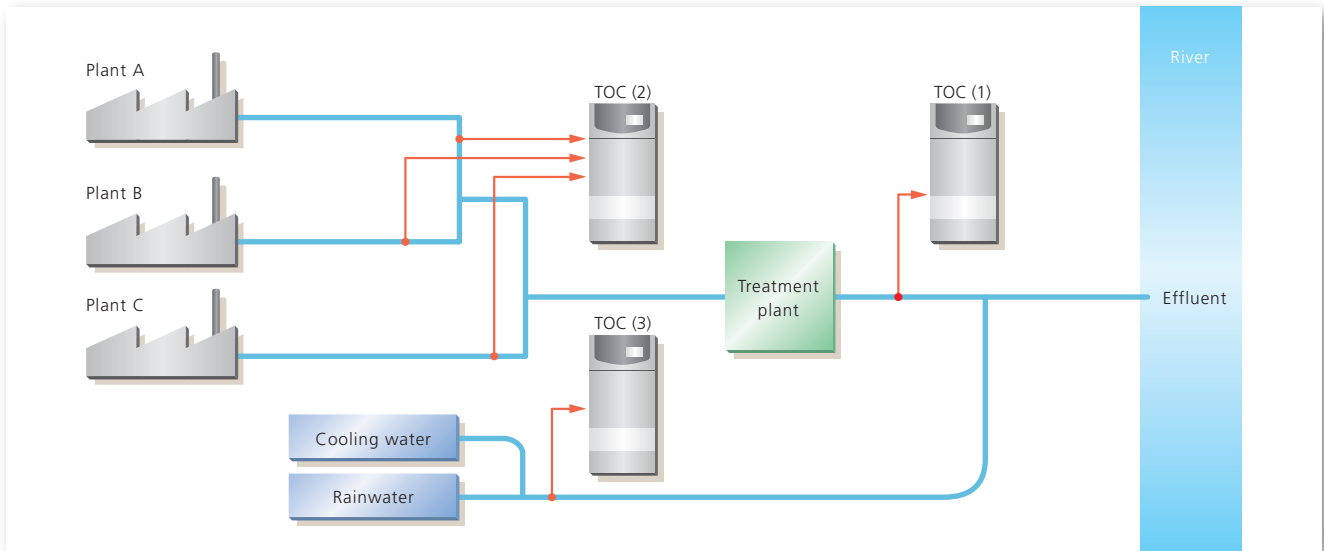

- TOC (1) Prevents water pollution accidents through rapid detection of abnormal effluent.
- TOC (2) Identifies the source of abnormal effluent to accelerate identification of the cause and prevention of recurrence (three-flow-line switching).
- TOC (3) Monitoring of effluent not from the treatment plant

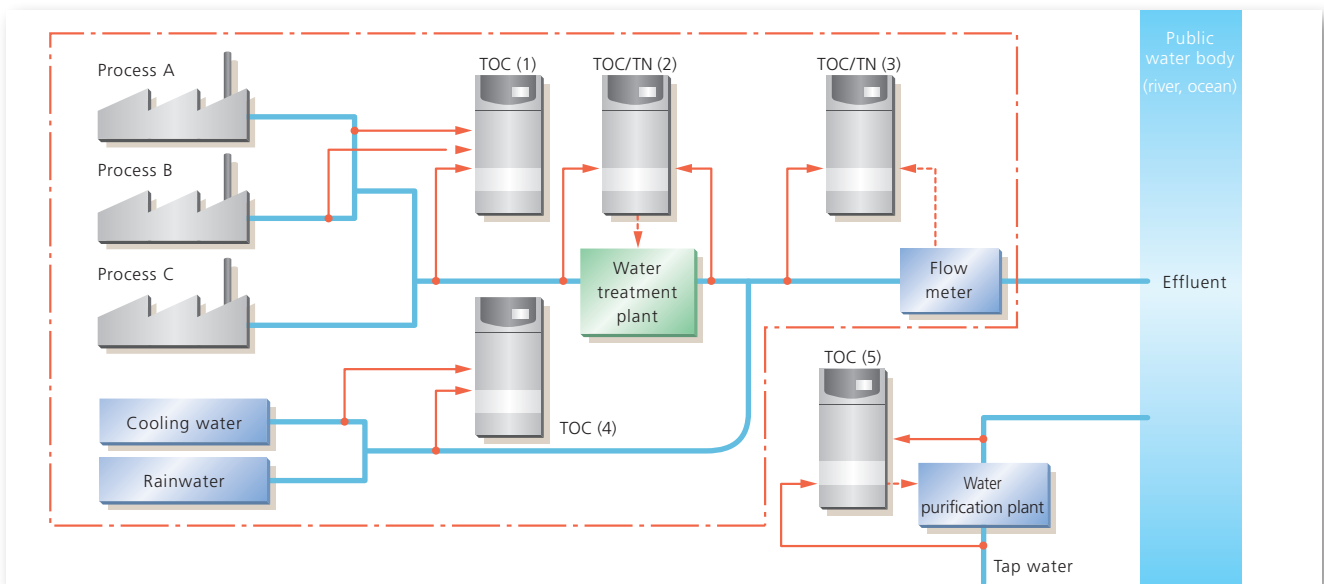

- TOC (1) Monitoring of TOC values discharged from each process (three-flow-line switching)
- TOC (2) Monitoring of inflow and outflow of water treatment plant (two-flow-line switching). Optimization control of treatment performance (amount of aeration, etc.) at the water treatment plant
- TOC (3) Monitoring of all effluent discharged from the enterprise. Load conversion calculations using flow rate signals input from a flow meter
- TOC (4) Monitoring of abnormal values for cooling water and rainwater. Monitoring for abnormalities in the pipe system (two-flow-line switching)
- TOC (5) Monitoring of water taken in the water purification plant. Monitoring for abnormalities in the tap water

Advanced Operability

Because on-line analyzer operation is normally unmanned, ease of operation was emphasized.

■ Color LCD touch screen

- Easy-to-view color LCD
- Touch screen operation
- Large buttons
- Easy-to-operate touch screen

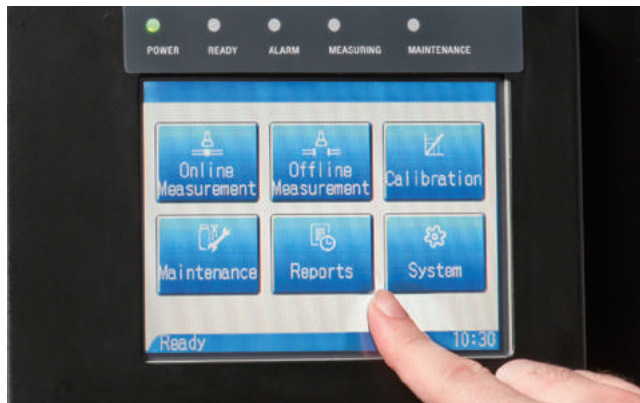

■ Intuitive setup, measurement start, and measurement stop operations

- When multiple flow lines are used, the measurement items, range and measuring cycle can be set separately for each flow line to simplify the setup of complex scheduled operations.

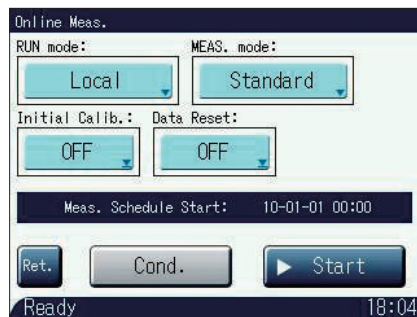

■ Generous data storage capacity

- The instrument internal memory can store 20,000 measured values (equivalent to one year's data at a 30-minute measuring cycle), 100 calibration values (equivalent to weekly automatic calibration over one year), and history of 100 alarms.
- Six calibration curves can be saved for each measurement type (TC, NPOC, IC*, POC*, and TN*) to simplify switching between operation conditions.
- USB port fitted as standard below the touch screen. Measured values and measurement conditions can be saved to USB memory. Measured results are saved as CSV files to simplify the management and processing of large quantities of data.



*Optional

Other Useful Functions

■ Interrupt measurements

- Off-line sample measurements and calibration can be performed in the standby time periods, even during on-line operation.

■ Control sample measurements

- Periodic measurements of pre-selected control samples. This can be used to monitor the condition of the instrument. Automatic calibration can be performed when a certain reference value is exceeded.

■ Calendar

- The calendar simplifies scheduling for automatic calibration, instrument sleep function, control sample measurement, and catalyst regeneration (up to 14 weeks). Batch inputs can be made by specifying a day of the week.

■ Compatible with digital bus standard

- Instrument operation, readout of measured values, and checking for alarms can be performed via the RS-485 or RS-232C (option). This function is convenient when managing multiple instruments.

■ Web-based monitoring (option)

- Installing an optional board allows connection of the instrument to a network. The optional board offers web-server functions, allowing real-time browsing of measured values and alarms with a Web browser.



Calendar

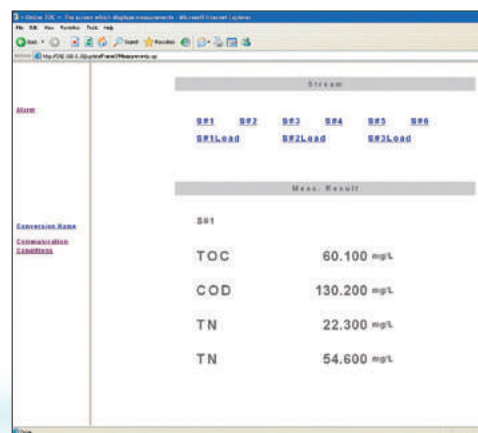

Web-Based Monitoring

Superior Sampling Units

Select the Unit to Match the Sample

Multi-Stream Suspended Solids Sampling Unit

- Used for samples with comparatively high suspended solids levels.
- It can treat samples in up to six flow lines.
- Separating the sampling unit and pretreatment unit reduces the number of parts requiring maintenance.
- Incorporates a homogenizer equipped with a strainer.
- The strainer is the most easily contaminated part. It is in contact with liquids during sampling only. It is rinsed with rinse water immediately after sampling.
- The pellet of germicide is put beside the sampling unit, reducing problems with slime and algae built-up.
- Required sample flow rate: Approx. 10 L/min
- A low-flow (LF) model has been newly added to the product lineup.
(Required sample flow rate: 1 to 2 L/min)

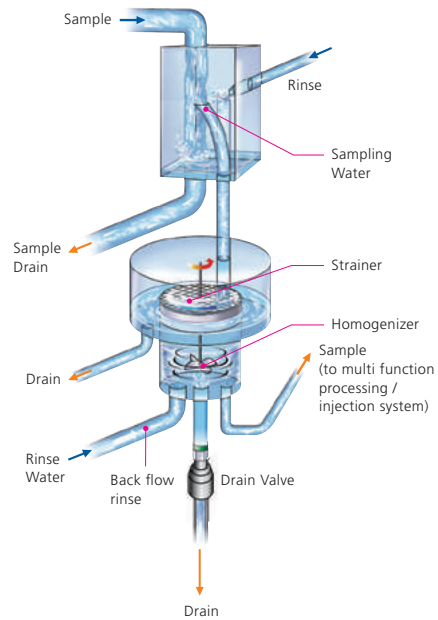

Single Stream Suspended Solids Sampling Unit

- Used for samples with comparatively high suspended solids levels.
- This sampling unit is electrically driven. It requires no air supply.
- After dirt is removed by the strainer, the homogenizer pulverizes and homogenizes the suspended solids to obtain stable measured values.
- The strainer is the most easily contaminated part. It is in contact with liquids during sampling only. It is rinsed with rinse water immediately after sampling, reducing problems with slime and algae build-up.
- A germicide is installed to effectively suppress slime and algae growth.
- Required sample flow rate: 2 to 5 L/min

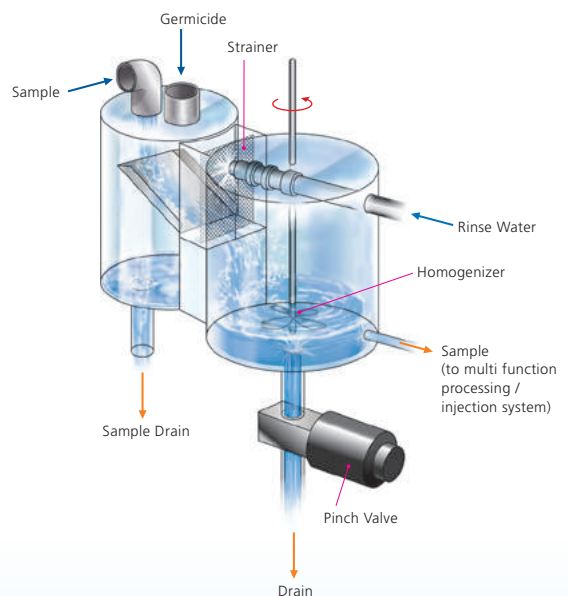

Backwash Strainer Sampling Unit

- This unit is an adjustment bath used for samples with low suspended solids levels.
- Offers automatic backwashing using air. The air source is either the carrier gas or the air supplied by pump.
- The float switch available, enabling sample flow detection.
- A germicide installed in the air line suppresses blockage of the strainer by microorganisms and growth of slime and algae in the bath.
- Required sample flow rate: 1 to 3 L/min

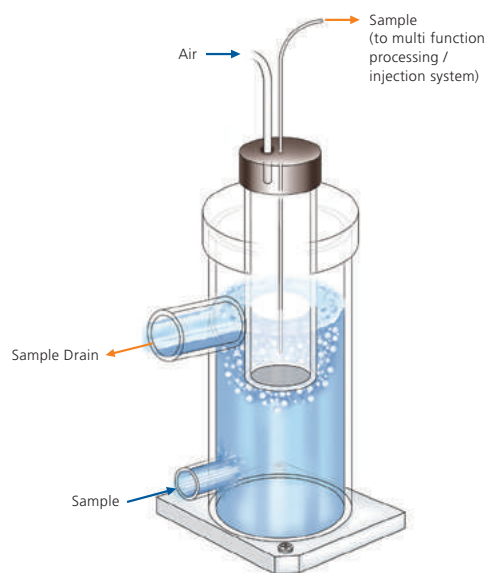

Multi-Stream Sample Switching Unit

- Used for samples with low suspended solids levels.
- It can treat samples in up to six flow lines.
- Assuming measurements of purified water, a water sampler is installed to minimize exposure of the sample to air.
- Required sample flow rate: 1 to 3 L/min

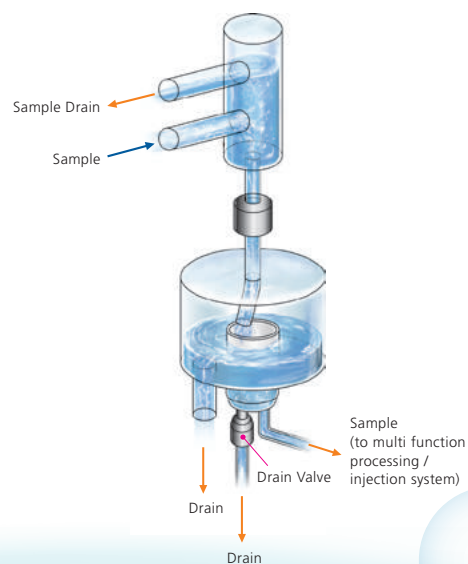

Options

Sampling Unit (Alternatives)	Part Name	Part Number	Remarks
	Multi-stream suspended solids sampling unit	638-93206-41 to 46	Sampling unit for samples with high suspended solids levels Capable of switching between a maximum of 6 flow lines Required sample flow rate: Approx. 10 L/min
	Multi-stream suspended solids sampling unit LF	638-93207-41 to 46	Low-flow rate version of the multi-stream suspended solids sampling unit Capable of switching between a maximum of 6 flow lines Required sample flow rate: 1 to 2 L/min
	Single stream suspended solids sampling unit	638-93186-41	Sampling unit for samples with high suspended solids levels Single stream only Required sample flow rate: 2 to 5 L/min
	Backwash strainer sampling unit (with pump)	638-41507-41	Sampling unit with automatic strainer backwashing using air Single stream only <ul style="list-style-type: none"> • (with pump): Backwashing air is supplied from the internal pump to the supply cylinder to reduce the air consumption. • (without pump): Backwashing air is supplied from carrier gas source. • "F": With float sensor This can detect if the sample water flow is interrupted. • "E": No disinfection by germicide Required sample flow rate: 1 to 3 L/min
	Backwash strainer sampling unit (without pump)	638-41507-42	
	Backwash strainer sampling unit F (with pump)	638-41507-43	
	Backwash strainer sampling unit F (without pump)	638-41507-44	
	Backwash strainer sampling unit E (with pump)	638-41507-45	
	Backwash strainer sampling unit E (without pump)	638-41507-46	
	Backwash strainer sampling unit EF (with pump)	638-41507-47	
	Backwash strainer sampling unit EF (without pump)	638-41507-48	
	Multi-stream sample switching unit	638-93193-41 to 46	
	Sample stream kit	638-41582-01, 02	Sampling unit for measurement of comparatively clean samples Single-flow-line (-01) and double-flow-line (-02) versions are available. As the second flow line uses the off-line port, off-line measurement functions are not available if the double-flow-line version (-02) is used. Required sample flow rate: 1 to 3 L/min
	Sample stream additional kit	638-41582-03	Expansion set to use the single-flow-line version of the sample stream kit as a double-flow-line version As the second stream uses the off-line port, off-line measurement functions are not available if the double-flow-line version (-02) is used.

External I/O	External I/O	Part Number	Remarks
	Optional terminal (2) kit	638-79078-41	Terminal (2) expansion kit Expanding contents: Analog output: 2 channels Contact input: 8 channels (For control 2 and 3 flow lines)
	Optional terminal (3) kit	638-79079-41	Terminal (3) expansion kit Required the option terminal (2) kit Expanding contents: Contact output: 26 channels Contact input: 8 channels (For control 4 to 6 flow lines)
	Optional terminal (2) (3) kit	638-79080-41	The kit for expanding Option terminal (2) kit and Option terminal (3) kit simultaneously
	Analog output board	638-79084-41	Each set offers two analog outputs. Required for five or more outputs. Up to four sets can be added (making 12 outputs maximum). Requires the PCB fixing bracket, terminal (638-84218), and optional terminal (2) kit (638-79078). (Isolated outputs, load resistance: 500 Ω max.)
	Analog input board	638-79083-41	For flow rate signal inputs (3 inputs) Requires the PCB fixing bracket, terminal (638-84218), and optional terminal (2) kit (638-79078). (Isolated inputs, CH-CH is non-isolated. Load resistance: 100 Ω)
	Data converter kit	638-79077-41	Separate programming is required to use the protocol conversion functions. The RS-232C set (638-66228) is required for communications. Requires the PCB fixing bracket, main (638-84217).
	PCB retaining fitting, terminal	638-84218	Required to expand the analog input/output boards (*).
	PCB retaining fitting, main	638-84217	Required to expand boards other than the analog input/output boards (*).
	RS-232C kit	638-66228	D-sub 9 pin (male)
	Web monitor unit set	638-79077-42	Required to use web-based monitoring.

(*) One required per instrument, even when adding multiple boards

Options

Recorder (Alternatives)	Part Name	Part Number	Remarks
	Printer kit	638-54066	Contains a printer and printer interface board.
	Recorder kit	638-54065-41	6-dot recorder set
	Recorder kit, without recorder	638-54065-42	Required when a recorder is prepared separately and installed in the instrument [Recorders available] • Mount panel cut-out: 138 mm×138 mm • Dimensions From the mount panel: Front: 46 mm max. Rear: 270 mm max. (incl. wiring) • Input: 0-1 V f.s.

Measurement Systems	External I/O	Part Number	Remarks
	TN option	638-92308-41	Unit for total nitrogen (TN) measurements
	Combustion tube kit for high salinity samples	638-93176-04	Required to measure sea water and other samples containing high salt levels.
	IC measurement option	638-57156-41	Unit for IC measurements
	IC-POC measurement option	638-57156-42	Unit for POC measurements It also can measure IC.
	N ₂ carrier gas kit	638-41574	Required to use high-purity nitrogen gas as the carrier gas.
	High sensitivity measurement option	638-42111-01	Capable of TOC measurements in the 0 to 1 mgC/L range Carrier gas source: High-purity air
	N ₂ carrier gas high sensitivity measurement option	638-42111-02	Capable of TOC measurements in the 0 to 1 mgC/L range Carrier gas source: High-purity nitrogen
	Standard solution switching kit 8	638-57177-41	Required to perform automatic calibration using 3 or more bottles of standard solution
	Standard solution switching kit 2	638-57176-41	Allows automatic calibration using a maximum of 2 bottles of standard solution

Others	External I/O	Part Number	Remarks
	Automatic diluent supply kit	638-57171-41	Valve set that purifies dilution water from tap water and supplies it
	Automatic pure water supply kit	638-57172	Valve set to directly supply purified water
	Stand kit	638-10308-41	A stand to use the unit free-standing
	Purge kit	638-40252	Plumbing set required to purge the interior of the cabinet with clean air.
	Power terminal block kit	638-68162	Required to supply a power with a terminal receptacle Terminal size: M4
	Regulator, AW30-02BG-N	040-82112-43	Air regulator with filter
	Regulator tubing kit	638-42064	Pipe set to attach the regulator (AW30-02BG-N)
	Air duct kit	638-41204	Contains a pipe and connectors for the carrier gas supply.

Specifications

Item	Description
Measurement Items	TC, NPOC Optional: IC, POC, TOC (= TC-IC, = NPOC + POC), TN
Measurement Principle	680 °C combustion catalytic oxidation - NDIR detection method
Measurement Range	From 0 – 5 to 0 – 1,000 mgC/L f.s. (0 to 20,000 mgC/L f.s. with dilution function)
Repeatability	Within ±2 % f.s. *1
Span Stability	Within ±2 % f.s./day (temperature variation within 5 °C) *1
Zero Stability	Within ±2 % f.s./day (temperature variation within 5 °C) *1
Measurement Cycle	4 minutes min. (NPOC, residual IC 2 % max.) *2
Sample Injection Method	Syringe pump/sliding injection port
IC Removal Method	Acidify/sparge within syringe
Sample Dilution Function	Dilution within syringe; dilution factor 2 to 50 Dilution accuracy: Within ±2 % (x2 to x20); within ±5 % (x21 to x50)
Auto-calibration Function	Automatic calibration using standard solution (Dilution water is used as the zero standard solution for zero-calibration.) Options can be attached to use up to eight standard solutions and to permit automatic calibration with up to a 5-point multi-point calibration curve.
Stream Switching Function	Permits switching of between 1 and 6 flow lines (optional).
Display / Operation	Color LCD with touch screen
Conversion Function	Conversion with a linear expression using required indices (Conversion expression must be determined in advance.)
Load Calculation Function	Using the analog input board (option) permits load calculations. (Isolated analog inputs (CH-CH is non-isolated.); load resistance: 100 Ω)
EPA TOC Removal Rate Calculation Function	TOC removal rate calculation according to the United States EPA regulations (Part IV 40 CFR Part 9, 141 and 142, 1998) (when a 2- or more-stream switching option is provided)
Data Storage Function	Store 20,000 past on-line measured values (equivalent to one year's data at a 30-minute measuring cycle). Offers trend graph displays.
Data Storage Device	Store measured values or measurement conditions to USB memory. (USB 1.1 or 2.0 USB memory; FAT16 or FAT32; no encryption)
Recorder	Recording width 100 mm, 6-dot recorder (optional)
Printer	Thermal printer, 40 characters per line; 110 mm chart width (optional)
Analog Output	Selectable between 4 – 20 mA DC or 0 – 16 mA DC (isolated outputs) With attached option: Up to 12 outputs (load resistance: 500 Ω max.)
Contact Output Signal	Alarm signals Major failure, instrument alarm, power cut, CPU alarm, concentration alarm (upper limit/lower limit/upper upper limit/lower lower limit), measurement halted Event signals Maintenance, measurement ready, on-line operation, measuring sample, calibrating, regenerating catalyst, measuring control sample, interrupt sample measurement, halted, analog output trigger, analog output flow line recognition signal, measured flow line recognition signal, sampling pump control output (contact capacity: 2 A, 30 V DC / 2 A, 250 V AC; non-inductive load)
Contact Input	Start calibration, stop measurement, start on-line measurement, reset alarm, measurement start flow line 1 to 6, halt measurement (output contact capacity: 24 V DC min., 10 mA min.)
Communications Functions	Compatible with RS-485, RS-232C (option), and Modbus Use the optional Web monitoring unit set to browse measured values and alarms on a Web browser over a network.
Carrier Gas	Pressurized air, high-purity air, oxygen*3; supply pressure: 250 to 300 kPa Optional: High-purity nitrogen*3
Power Supply	AC 100 to 240 V ± 10%, 10 A, 50/60 Hz
Ambient Temperature	Within 1 to 40 °C
Construction	Indoor wall mounting (optional stand available)
Dimensions	W550 × D383 × H1240 mm (excluding protrusions)
Weight	Approx. 70 kg

*1) With automatic settings

*2) When measured sample is potassium hydrogen phthalate solution and operations to prepare for the next measurement are performed.

*3) If TN option is installed, oxygen and high-purity nitrogen cannot be used.

Specifications

■ IC Measurement Option

Item	Description
Measurement Item	IC (inorganic carbon)
Measurement Principle	Sparging / CO ₂ removal / non-dispersive infrared gas detection (NDIR) method
Measurement Range	0 to 100 mgC/L f.s. (up to 5,000 mgC/L f.s. with dilution function)
Repeatability	Within ±2 % f.s.

■ IC-POC Measurement Option *¹

Item	Description
Measurement Item	POC (purgeable organic carbon)
Measurement Principle	Sparging / CO ₂ removal / 680 °C combustion oxidation / non-dispersive infrared gas detection (NDIR) method
CO ₂ Removal Method	Absorption and removal with lithium hydroxide crystals
Measurement Range	0 to 50 mgC/L f.s. (up to 2,500 mgC/L f.s. with dilution function)
Repeatability	Within ±2 % f.s.

*1) IC (inorganic carbon) can also be measured. IC measurement performance is the same as that of IC measurement option.

■ TN Option

Item	Description
Measurement Item	TN (total nitrogen)
Measurement Principle	720 °C thermal decomposition / chemiluminescence detection
Measurement Range	From 0 – 1 to 0 – 200 mgN/L f.s. (up to 0 – 10,000 mgN/L f.s. with dilution function)
Repeatability	Range up to 4 mgN/L f.s.: Within ±4 % f.s. Range above 4 mgN/L f.s.: Within ±2 % f.s.
Analysis Cycle	4 minutes min. * ¹

*1) When the sample is ammonium sulfate and preliminary sampling is performed for next measurement

■ N₂ Carrier Gas Kit

Item	Description
Measurement Item	TC, NPOC With attached option: IC, POC, TOC (= TC-IC, = NPOC + POC) * TN cannot be measured
Measurement Range	0 to 1,000 mgC/L f.s. (up to 20,000 mgC/L f.s. with dilution function)
Supply Gas	High-purity nitrogen gas (CO, CO ₂ , and HC are all below 1 ppm.)

■ High Sensitivity Measurement Option

Item	Description
Measurement Item	TC, NPOC * IC/POC/TN cannot be measured
Measurement Range	0 to 1 mgC/L f.s.
Repeatability	Within ±2 % f.s.
Supply Gas	High-purity air

■ N₂ Carrier High Sensitivity Measurement Option

Item	Description
Measurement Item	TC, NPOC * IC/POC/TN cannot be measured
Measurement Range	0 to 1 mgC/L f.s.
Repeatability	Within ±2 % f.s.
Supply Gas	High-purity air (CO, CO ₂ , and HC are all below 1 ppm.)

■ High-Salt Sample Combustion Tube Kit *¹ *² *³

Item	Description
Measurement Concentration Range	TC, NPOC: 0 to 20,000 mgC/L (dilution performed for measurement exceeding 1,000 mgC/L) TN: 0 to 500 mgN/L (dilution performed for measurement exceeding 10 mgN/L)
Repeatability	TC, NPOC: Within 3 % TN: Range up to 4 mgN/L f.s.: Within ±4 % f.s.; Range above 4 mgN/L f.s.: Within ±2 % f.s.

*1) Salt concentration in sample is approximately 3 % (not guaranteed).

*2) Permits approximately 2,500 measurements when injecting 40 µL seawater (not guaranteed).

*3) Use sulfuric acid as the acid. For TN measurements, spike the sample with sulfuric acid.

External Dimensions and Maintenance Space

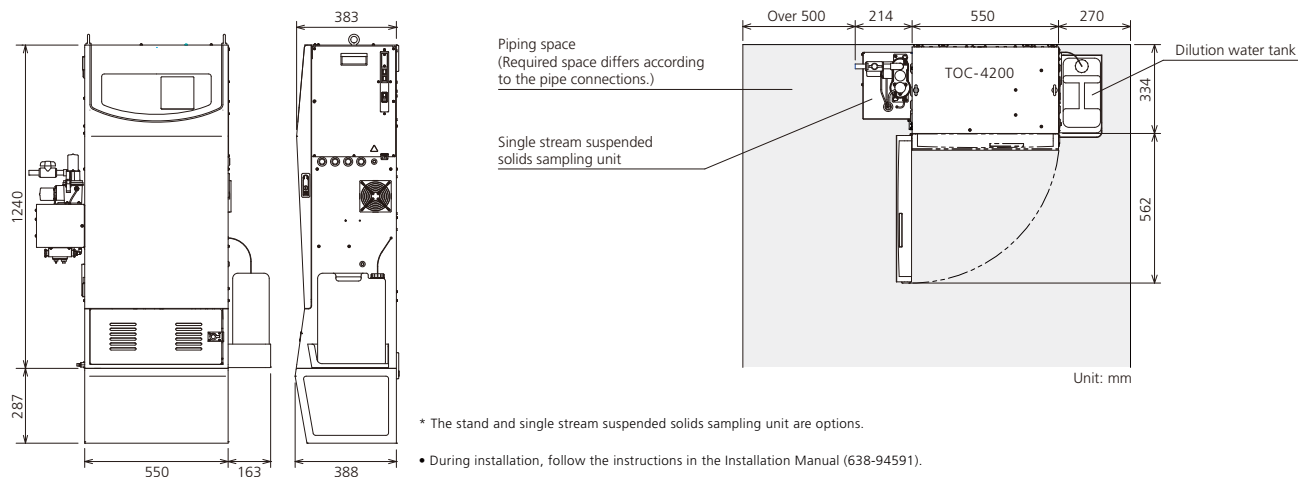

Standard Accessories

Part Name	Part Number	Qty	Remarks
Platinum catalyst ST type, 33g	638-60116	1	
Combustion tube, case included	638-41323	1	
L-shaped combustion tube, case included	638-42013	1	
Quartz wool (1 g included)	630-00557	1	
Ceramic fiber	638-60074	20g	
Platinum mesh, 2 pieces	630-00105-01	1	
B-type halogen scrubber mesh	631-60069	4	One mesh installed already
Container, 10L (for diluent)	638-52446	1	
Syringe, 5mL	638-59231	1	
Nut, M12 (SUS)	023-04074	4	
TOC-4200 User Manual	638-94581	1	

Consumable Parts

Part Name	Part Number	Remarks
Combustion tube, case included	638-41323	
Platinum catalyst ST type, 33g	638-60116	combustion catalytic
Quartz wool (1 g included)	630-00557	For L-shaped and other combustion tubes
Ceramic fiber	638-60074	For TN/TOC measurement catalysts
High sensitivity TC catalyst	630-00996	For replacing high sensitivity TC catalysts
O-ring, 4DP10A	036-11209-84	Set of 5 pcs
O-ring, Teflon P10	036-11408-84	Set of 5 pcs
O-ring, 4DP20	036-11219-84	Set of 5 pcs
Plunger tip, 5mL	638-59231-01	For Syringe
CO ₂ absorber	630-00999	For carrier gas purifier etc.
Absorbent stainless steel mesh	631-60069	For B-type halogen scrubber
Halogen scrubber	630-00992	
Ozonizer ASSY	638-71162-01	For maintaining ozonizer
Ozone deactivator catalyst	638-65232	300 g
Viton tube set	638-42015	For chemiluminescence detector effluent
Polypropylene cotton	630-00325	100 g
Packing	631-43578	For chemiluminescence detector
Printer chart paper	630-08913-01	For printer (option), 10 rolls
Recorder chart paper, EM-100	080-82564-51	For recorder (option), 0~100 graduations, 15 packs
Ink pad	080-82564-55	For 6-dot recorder
Consumables Set for TOC-4200	638-92310-01	The set for one year on a standard operating condition
Consumables Set for TOC-4200TN	638-92310-02	The consumables set in the case of using the TN option. The set for one year on a standard operating condition



Company names, product/service names and logos used in this publication are trademarks and trade names of Shimadzu Corporation or its affiliates, whether or not they are used with trademark symbol "TM" or "®". Third-party trademarks and trade names may be used in this publication to refer to either the entities or their products/services. Shimadzu disclaims any proprietary interest in trademarks and trade names other than its own.

For Research Use Only. Not for use in diagnostic procedures. The contents of this publication are provided to you "as is" without warranty of any kind, and are subject to change without notice. Shimadzu does not assume any responsibility or liability for any damage, whether direct or indirect, relating to the use of this publication.