

House	G34.360550	Sheet	1
Drawing	3D	Scale	
Material	34x135	Date	15.02.2016
Drawer	RP	File	G34.360550_3D.dwg

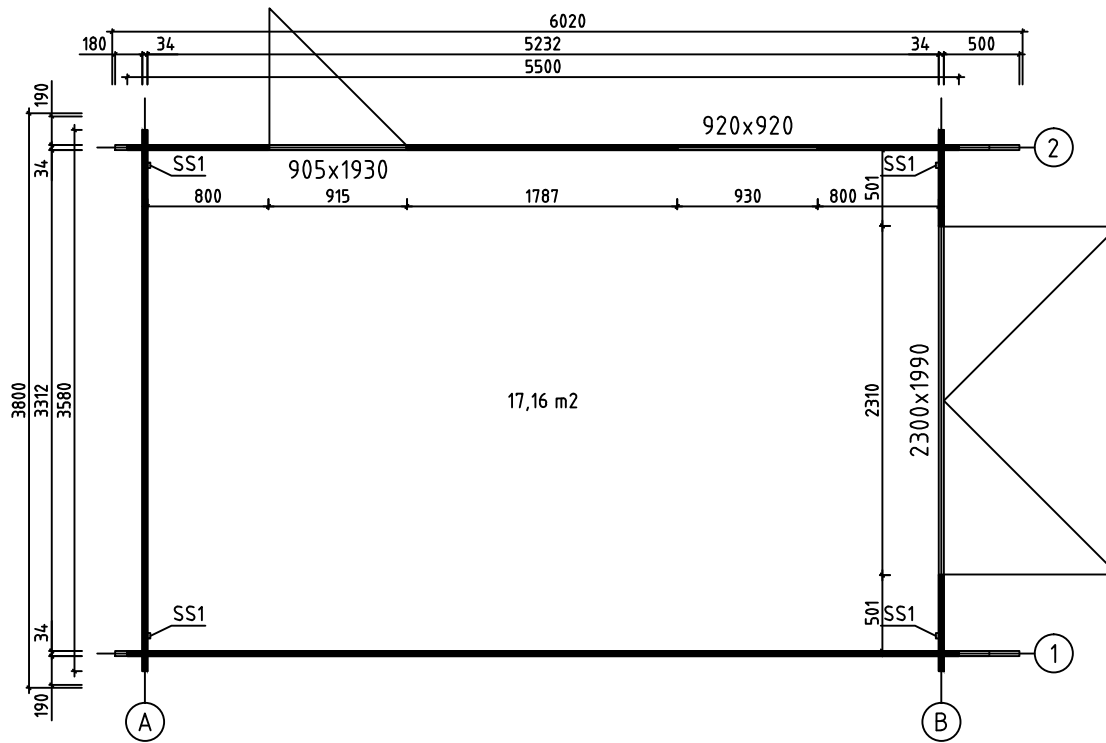

House	G34360550	Sheet	2
Drawing	GROUNDPLAN	Scale	1:50
Material	34x135	Date	15.02.2016
Drawer	RP	File	G34360550.dwg

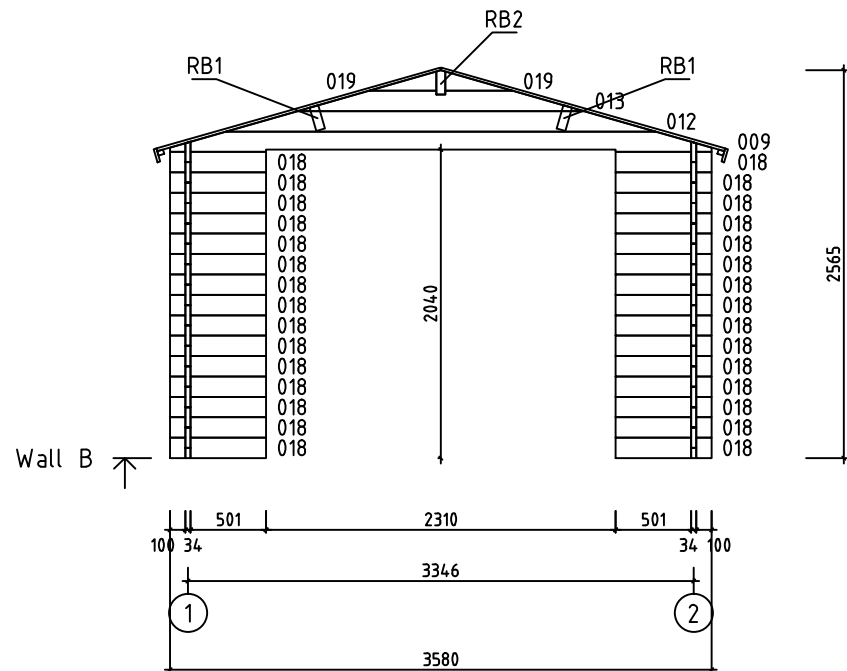



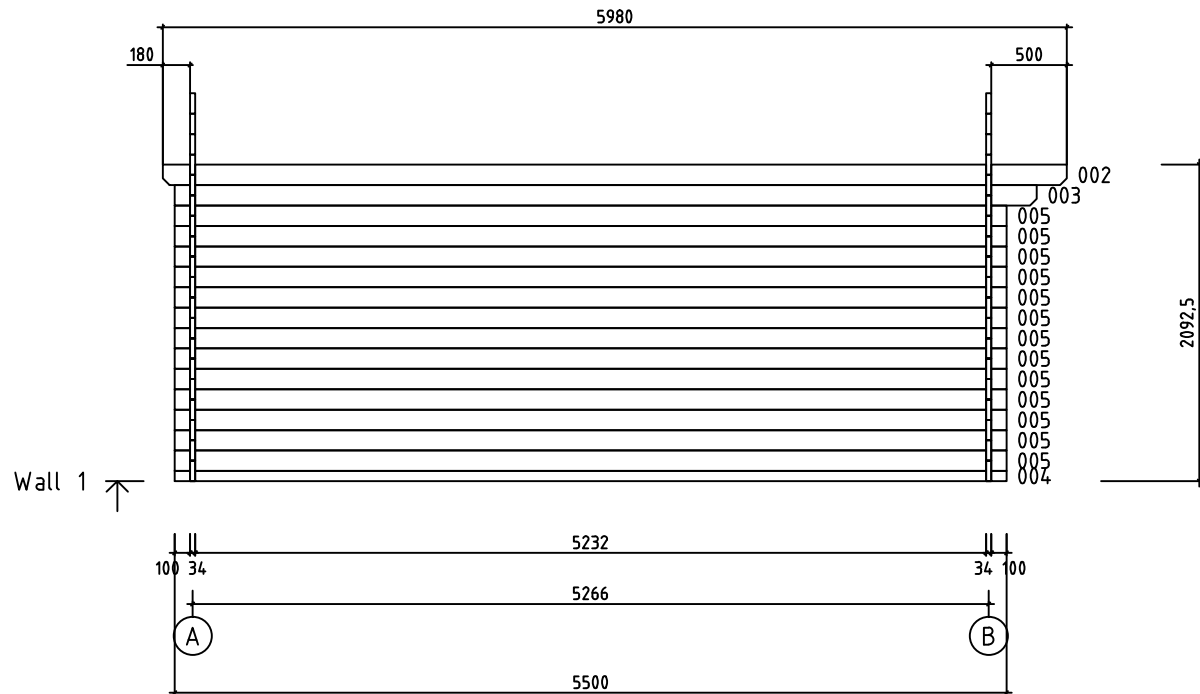

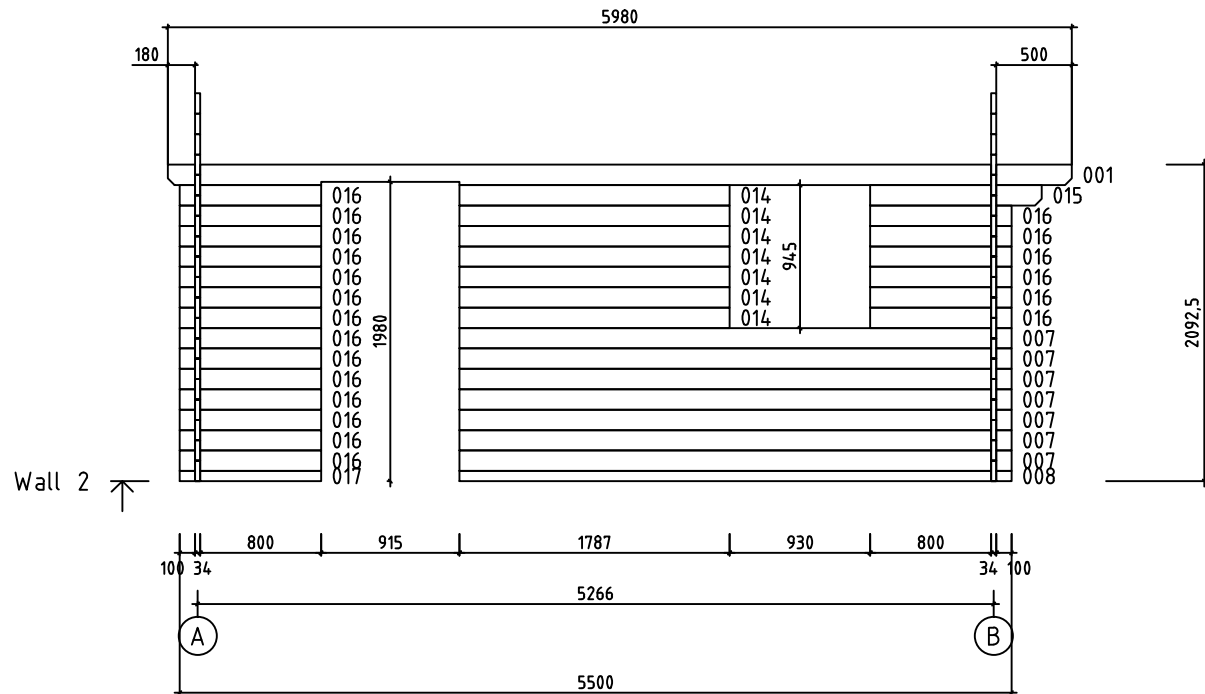

House	G34360550	Sheet	4
Drawing	WALL B	Scale	1:50
Material	34x135	Date	15.02.2016
Drawer	RP	File	G34360550.dwg

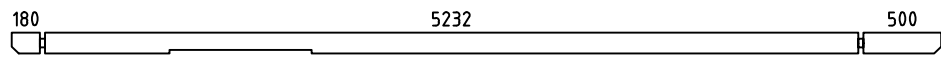
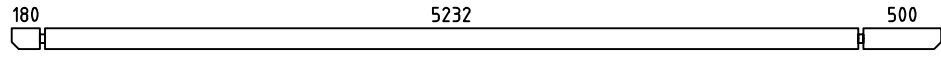
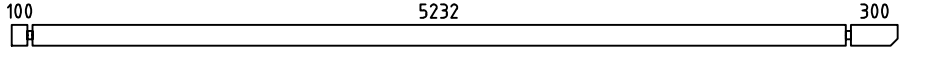
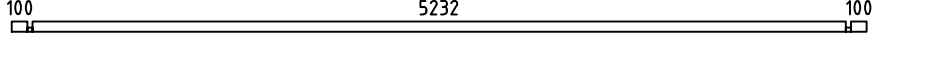
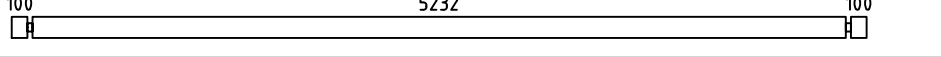
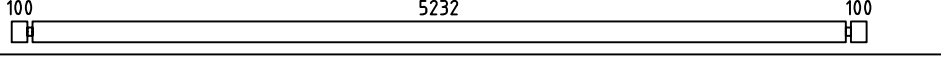
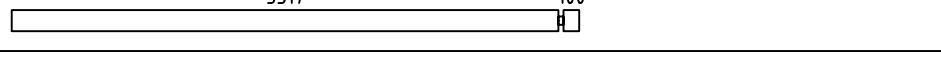
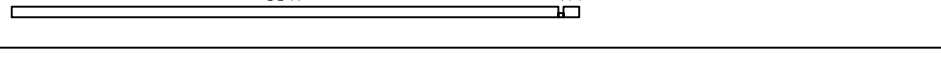
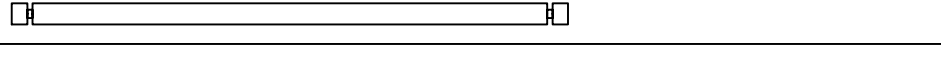
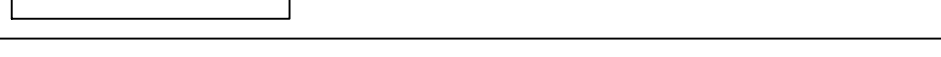
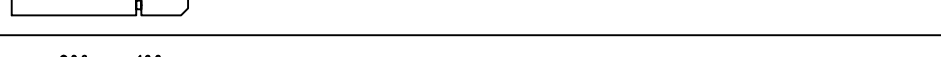
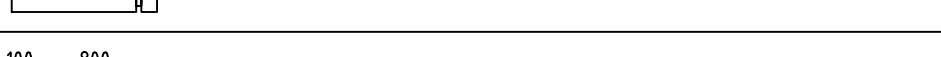
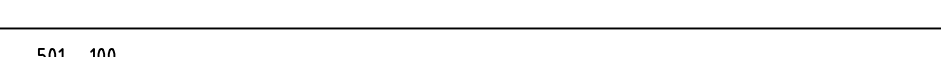
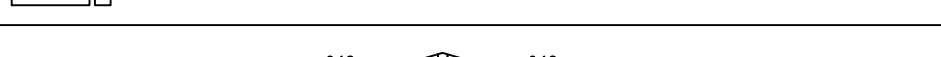
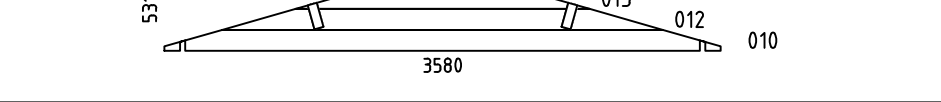
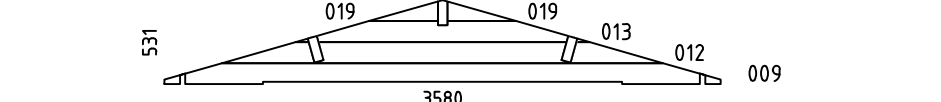

House	G34360550	Sheet	5
Drawing	WALL 1	Scale	1:50
Material	34x135	Date	15.02.2016
Drawer	RP	File	G34360550.dwg

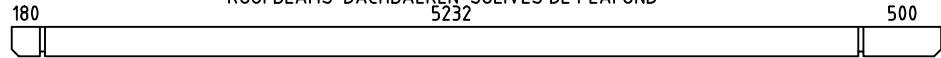
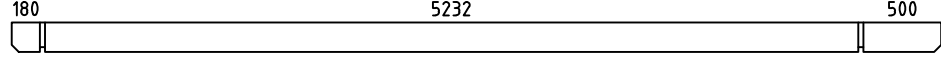

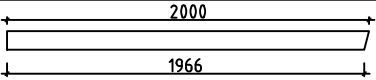
House	G34360550	Sheet	6
Drawing	WALL 2	Scale	1:50
Material	34x135	Date	15.02.2016
Drawer	RP	File	G34360550.dwg

Pos	Specification-Bestimmung-Spécification	PCS	Profile (mm)	L (mm)
001		1	34x135	5980
002		1	34x135	5980
003		1	34x135	5700
004		1	34x68	5500
005		13	34x135	5500
006	SPARE BEAM-ERZATZBOHLE-MADRIER DE RÉSERVE 	1	34x135	5500
007		7	34x135	3651
008		1	34x68	3651
011		15	34x135	3580
014		7	34x135	1787
015		1	34x135	1134
016		20	34x135	934
017		1	34x68	934
018		30	34x135	635
WA-1		1	34x531	3580
WB-1		1	34x531	3580
HB	HIT BLOCK-SCHLAGHÖLZER-MADRIERS D'ASSEMBLAGE 	2	34x135	300
RB1	ROOFBEAMS-DACHBALKEN-SOLIVES DE PLAFOND 	2	68x190	5980
RB2	ROOFBEAMS-DACHBALKEN-SOLIVES DE PLAFOND 	1	68x190	5980
R1	ROOFBOARD-DACHBRETT-VOLIGES  or-oder-ou	106+2 138+2	114x19 88x19	1950
GB1	GABLE BOARD-GIEBELLENDE-PLANCHE DE RIVE 	4	19x120	2000
GS1	ROOF FELT FILLET-GIEBELLEISTE-BAGUETTES POUR FIXER LES PLANCHES DE RIVE 	4	19x70	2000
EB1	EAVE BOARD-TRAUFBRETT-LATTES SOUS VOLIGES 	4	19x90	2990
House G34360550		Material	File G34360550.dwg	Sheet 7

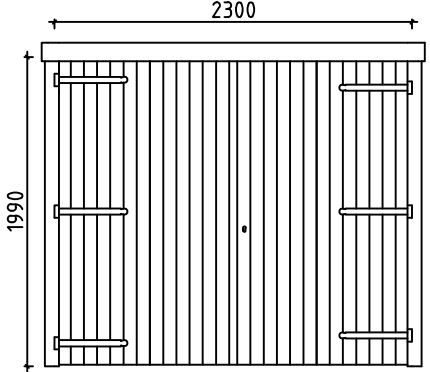
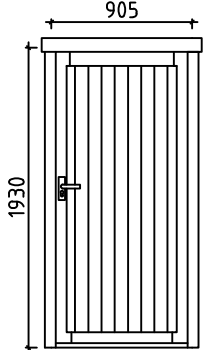
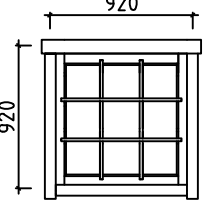
Pos	Specification-Bestimmung-Spécification	PCS	Profile (mm)	L (mm)
	GARAGE DOOR-GARAGENTOR-PORTE DE GARAGE (right-rechts-droit) GV 	P	1	2300
	DOOR-TÜR-PORTE (right-rechts-droit) AST_PL 	P	1	905
	WINDOW-FENSTER-FENÊTRE (right-rechts-droit) AST_KP_PL 	P	1	920
House	G34360550	Material	File	G34360550.dwg
Sheet				9

#001	2	5980	1
#002	1	5980	1
#003	1	5700	1
#004	1	5500	1
#005	1	5500	13
#006		5500	1
#007	2	3651	7
#008	2	3651	1
#009	B	3580	1
#010	A	3580	1
#011	A	3580	15
#012	A,B	2839	2
#013	A,B	1893	2
#014	2	1787	7
#015	2	1134	1
#016	2	934	20
#017	2	934	1
#018	B	635	30
#019	A,B	443	4