



## Yuasa Fiche de données techniques

### Yuasa YTZ10S - High Performance Maintenance Free batterie

#### Performance

Tension	12V
Capacity (10-hour)	8.6Ah
Capacité (20 heures)	9.1Ah
CCA @ -18°C	190A

#### Dimensions (±2mm)

Longueur	150mm
Largeur	87mm
Hauteur	93mm

#### Poids & Mesures

Poids moyen avec acide	3.2kg
------------------------	-------

#### Mounting Angle

Angle A	40°
Angle B	90°
Angle C	15°

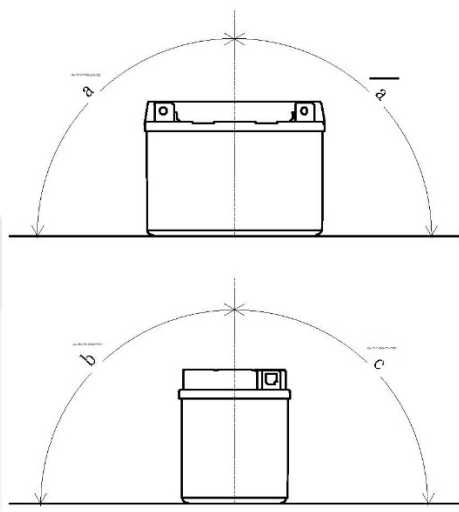

#### Technologie

Technologie  
Séparateur

Exp Ca/Ca  
AGM

#### Schéma de montage des éléments

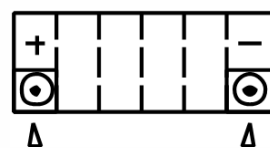

#### Type de bornes - 11



Date de publication: 17/11/2016 - E&OE



## Yuasa Technical Data Sheet

### Yuasa YTZ10S - High Performance Maintenance Free Battery

#### Performance

Voltage	12V
Capacity (10-hour)	8.6Ah
Capacity (20-hour)	9.1Ah
CCA @ -18°C	190A

#### Dimensions (±2mm)

Length	150mm
Width	87mm
Height	93mm

#### Weights & Measures

Mean Weight with Acid	3.2kg
-----------------------	-------

#### Mounting Angle

Angle A	40°
Angle B	90°
Angle C	15°

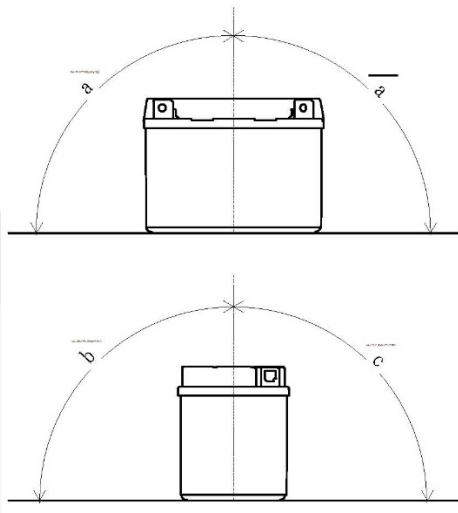

#### Technology

Technology  
Separator

Exp Ca/Ca  
AGM

#### Cell Assembly Layout

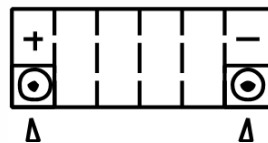

#### Terminal Type - 11



Data Sheet generated on 17/11/2016 - E&OE