

Comptoir Parapluie 2x2

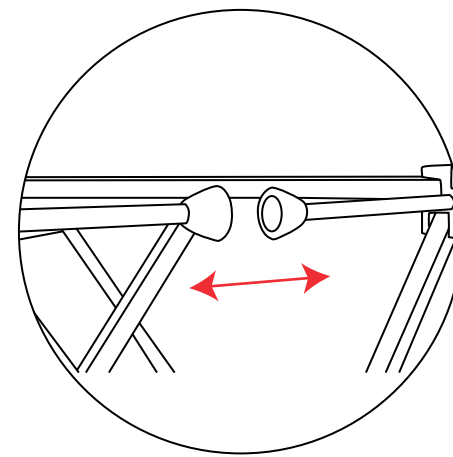

1

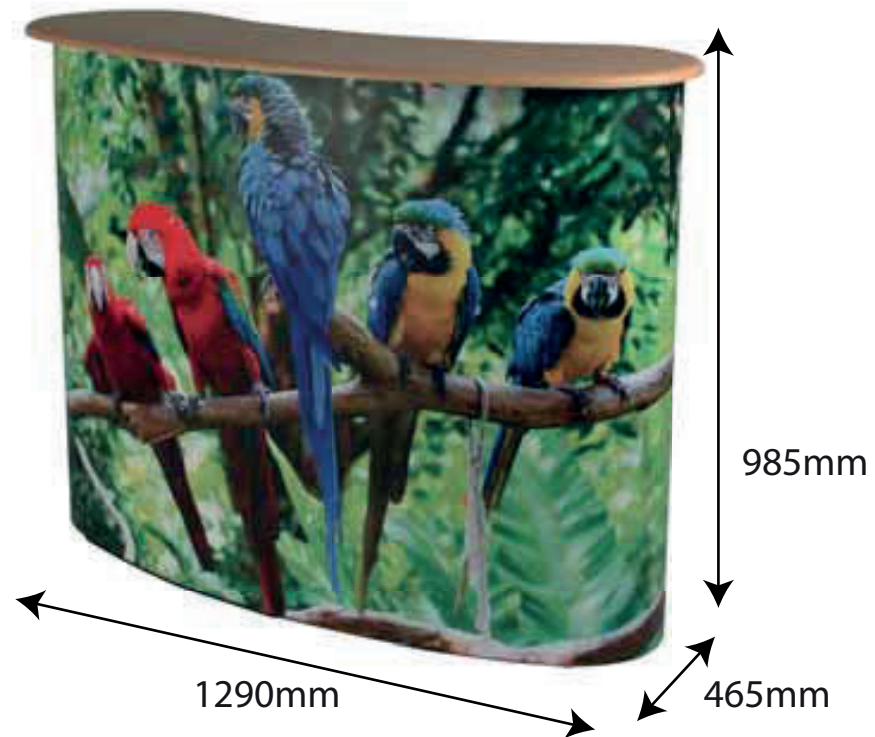
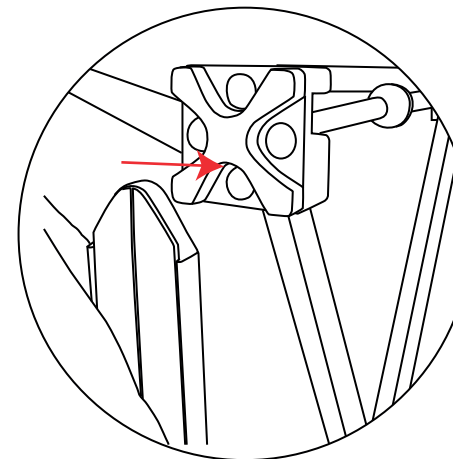
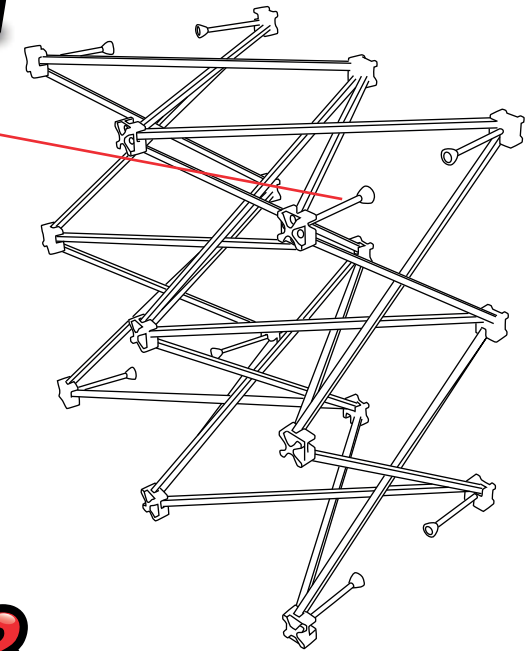

2

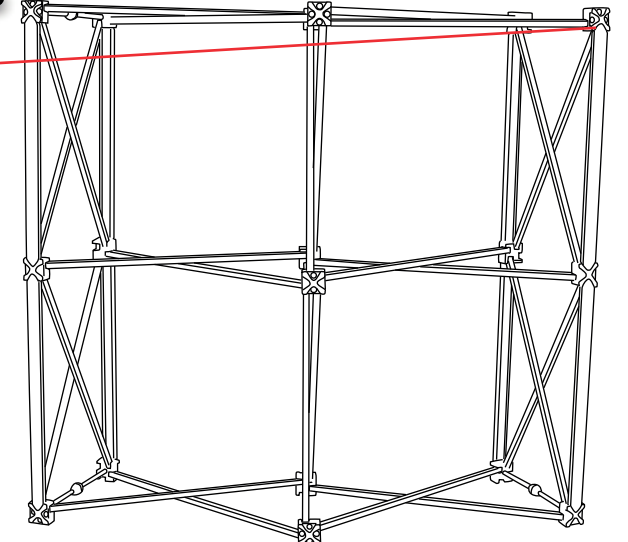

Inclus :

- x1 Rouleau magnétique
- x1 Structure
- x1 Tablette
- x4 Étagères internes (26,5x46cm)
- x1 Plinthe
- x1 Suspente



x1 X10 x1 x4

kg
Poids: 13.87kg



Surface visible du visuel : 950mm (h) x 2060mm (l)
Épaisseur recommandé du visuel : 440microns min

Comptoir Parapluie 2x2

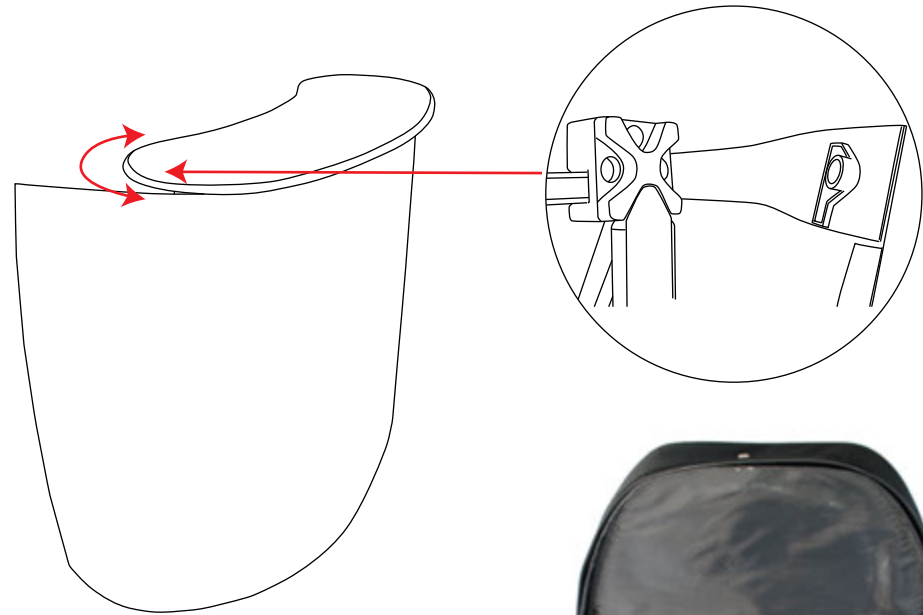
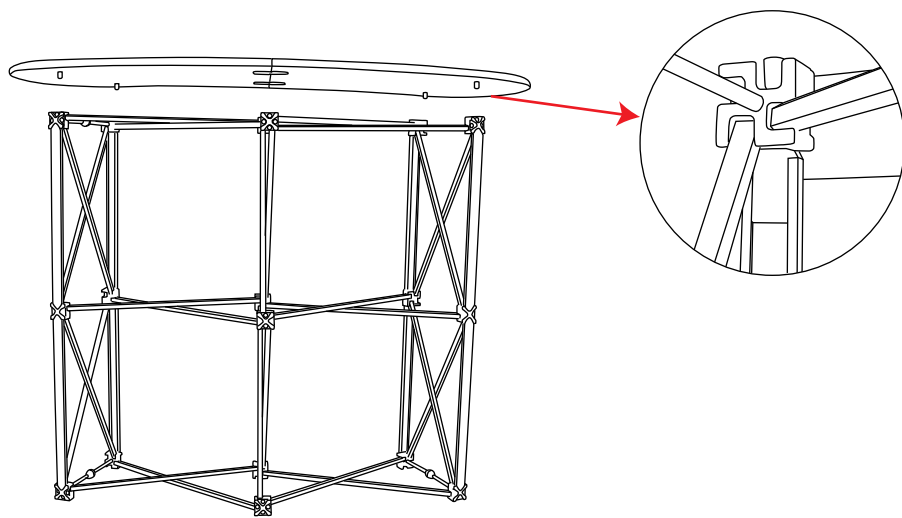

Installation des étagères

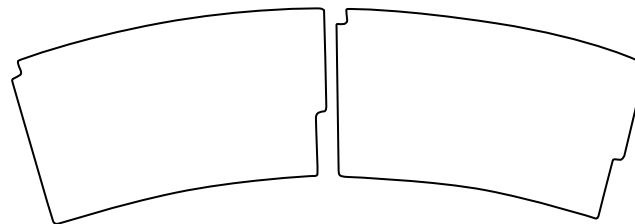
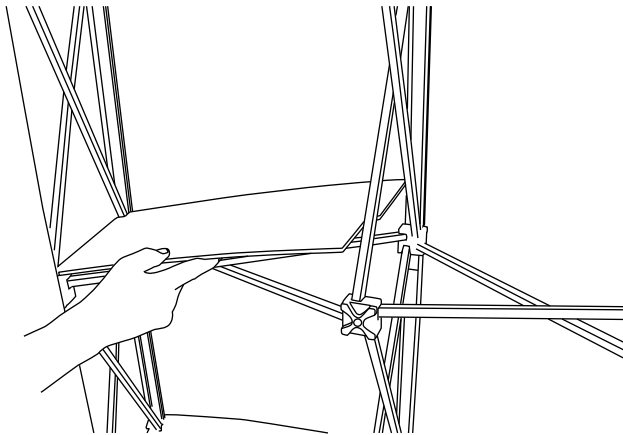

Comptoir Parapluie 2x2

Installation du visuel

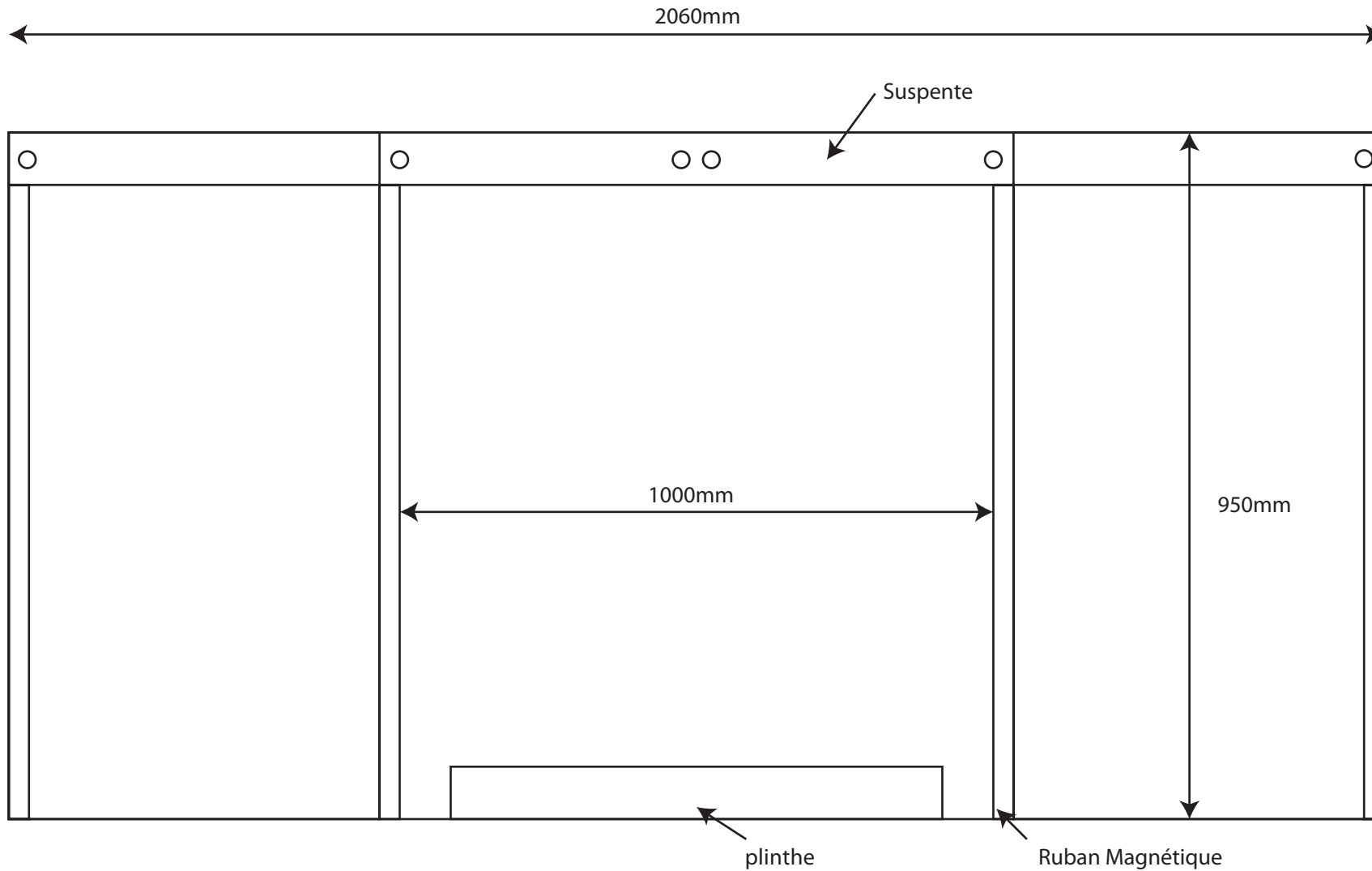

Comptoir Parapluie

Installation