

**1955 – 2021**

**Présentation**

# Les sites européens



# Groupe

Weidner GmbH

Allemagne

Weidner *IBERICA* S.L.

Espagne

Weidner S.A.R.L.

France

Weidner Mexico

Mexique

Weidner-Kovinarska

Slovénie

Polypres Mediterraneo S.A.

Espagne

Kölsch + Krug

Allemagne

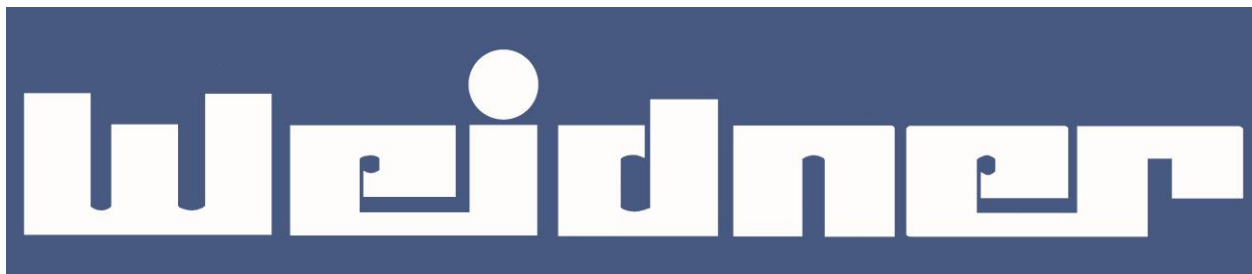

**Weidner GmbH**

*Sudetenstrasse 8*

*D-85107 Baar-Benhausen*

*[www.weidnergmbh.de](http://www.weidnergmbh.de)*

*Création 1955*

*Sur 10000 m<sup>2</sup> :*

*65 personnes*

Etude et développement

Prototypage

Atelier d'outillage et  
d'injection

Administration

11 presses à injecter (de 40T  
à 800T)

Conception et fabrication des  
moules

Fabrication bacs plastiques

Banc de mesure tri-  
dimensionnel





**KOVINARSKA VRHNIKA**

---

---

**AUTOCON d.o.o.**

*Sinja Gorica 106*

*SLO-1360 Vrhnika*

*[www.kovinarska.com](http://www.kovinarska.com)*

***Achat 1995***

Sur 35000 m<sup>2</sup> : 80 personnes  
Prototypage et pré série  
Fabrication série et montage  
Aménagements de camions  
Administration



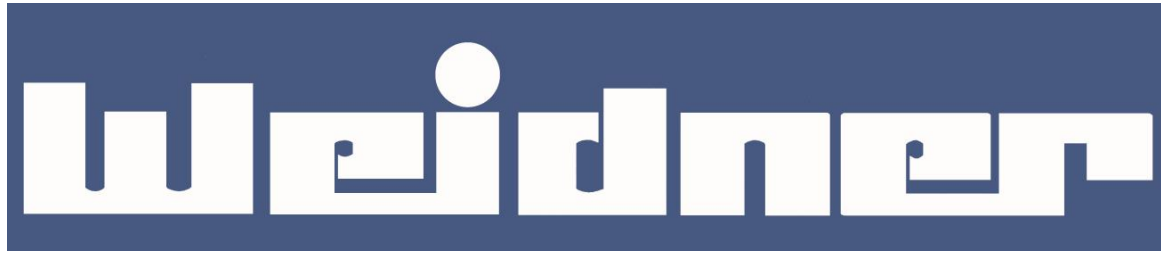

**WEIDNER IBERICA S.L.**

*C / Tramontana 8*

*E-46540 CARLET*

*[www.weidneriberica.com](http://www.weidneriberica.com)*

*Création 1993*



Sur 3000 m<sup>2</sup> : 50 personnes:  
Etude et développemet  
Prototypage  
Atelier d'outillage et d'injection  
Administration

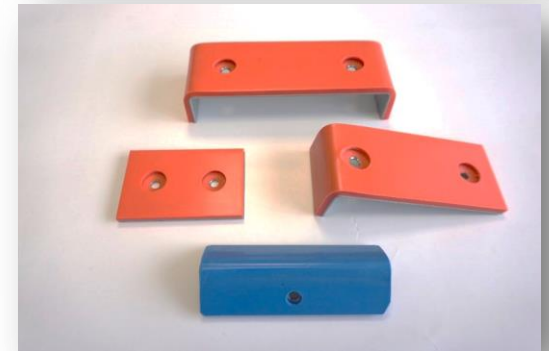

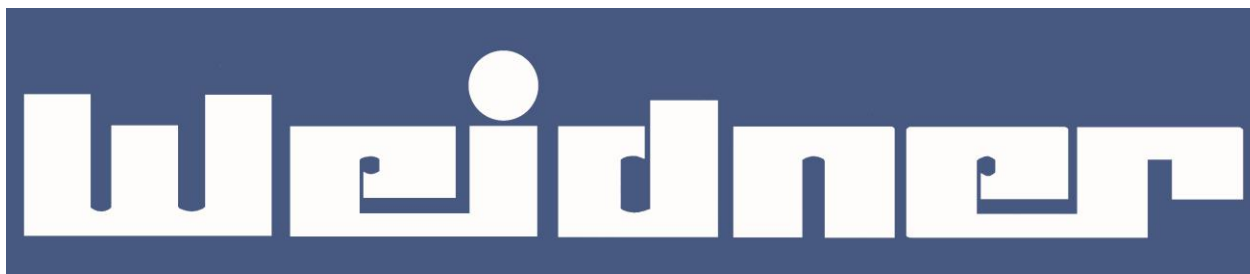

**WEIDNER S.A.R.L**

*24, rue de la Savonnerie*

*F-68460 LUTTERBACH*

*[www.weidner.fr](http://www.weidner.fr)*

*Création 1999*

Sur 1000 m<sup>2</sup> : 10 personnes

Etude et développement

Prototypage

Suivi de projet

Administration



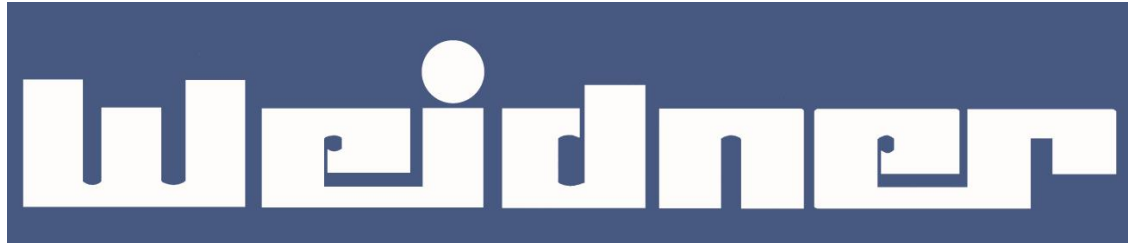

## **WEIDNER NORD**

Z.A.E. de Blanc Misseron

F-59920 QUIEVRECHAIN

*[www.weidner.fr](http://www.weidner.fr)*

**Création 2011**

**Sur 5000 m<sup>2</sup> :** 15 personnes  
Maintenance réparations modifications  
Prototypage  
Petites séries  
Suivi de projet





4000m<sup>2</sup> de surface de stockage



1000m<sup>2</sup> d'atelier



400m<sup>2</sup> de hall soudure

4 postes de montage soudure  
semi-auto



## 500m<sup>2</sup> de hall de montage et débit





Cabine peinture 6x3m  
Plieuse 3m  
Cisaille 2,5m  
Scie ruban

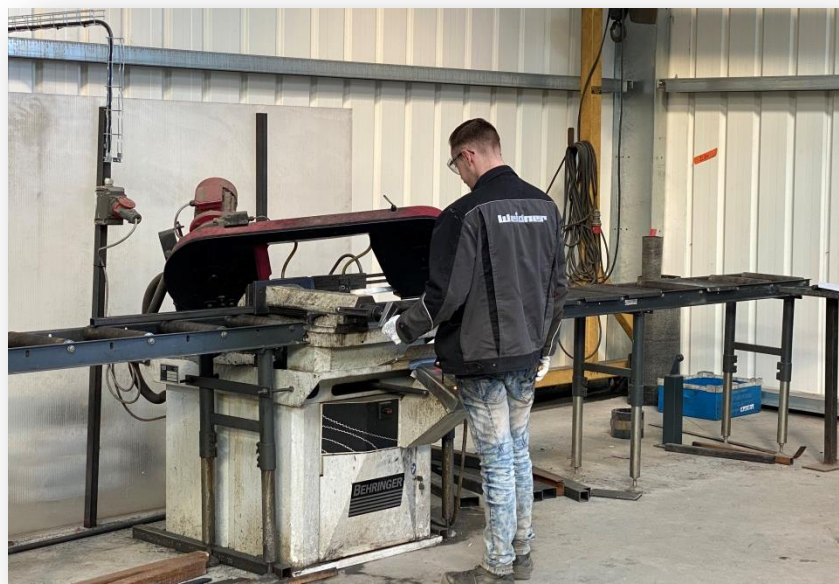



Bureau d'études : 2 stations Catia V5  
2 stations Creo 3

Imprimante 3D pour prototypage  
Traceur A0

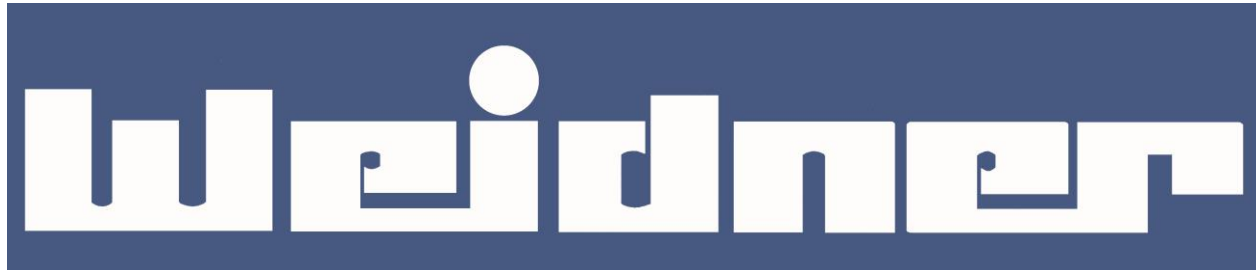

# **Intervention et maintenance sur site**

**Création 2007**



# ALSTOM





**TOYOTA**





**MCA**  
MAUBEUGE CONSTRUCTION AUTOMOBILE



# Colonne à taquets

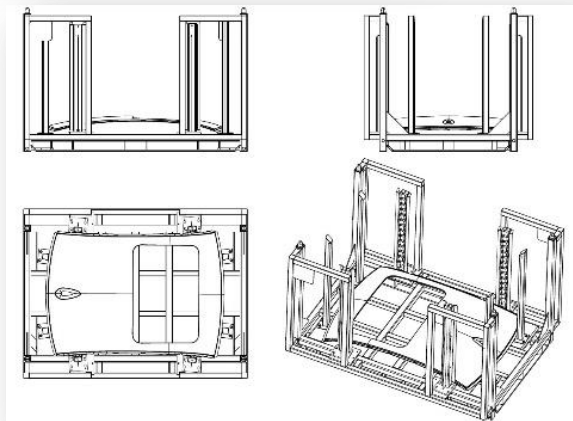
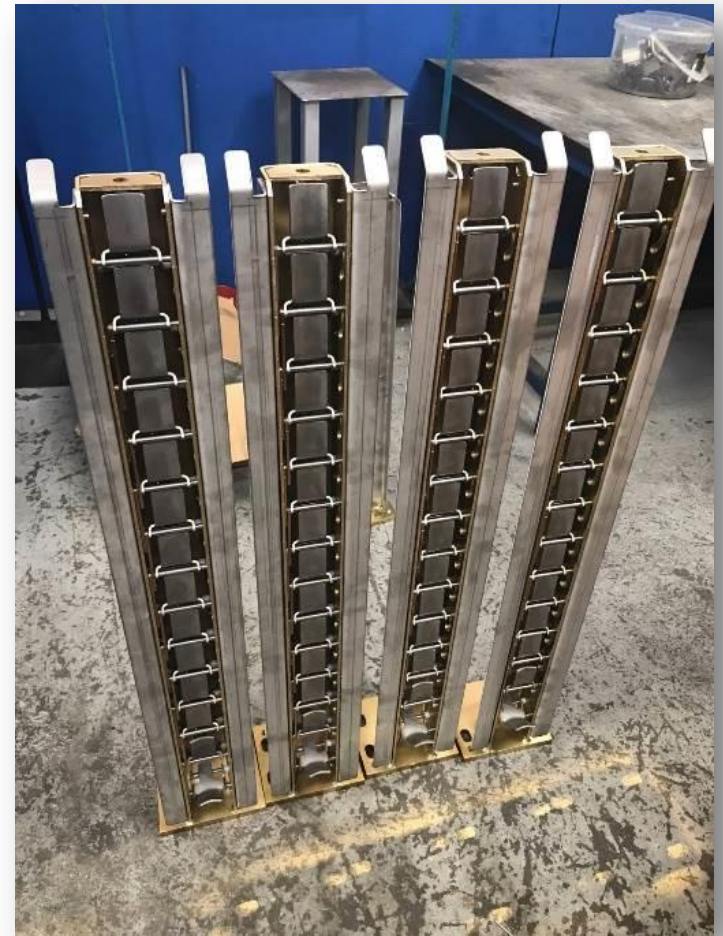
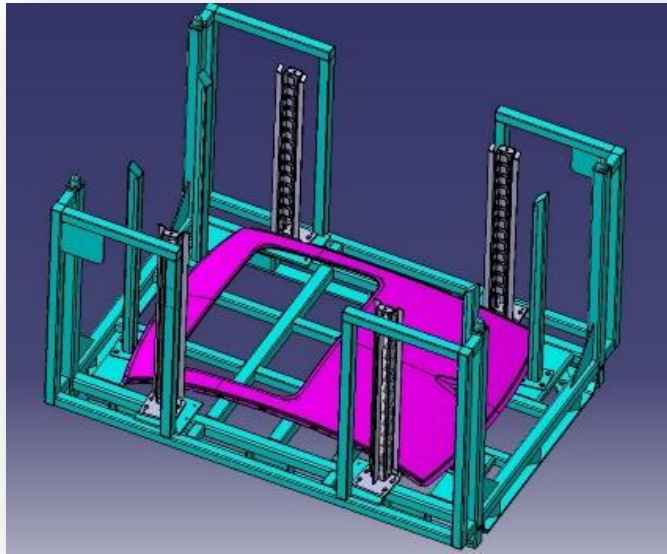





# Conteneurs spécifiques





# Aménagements de containers maritimes

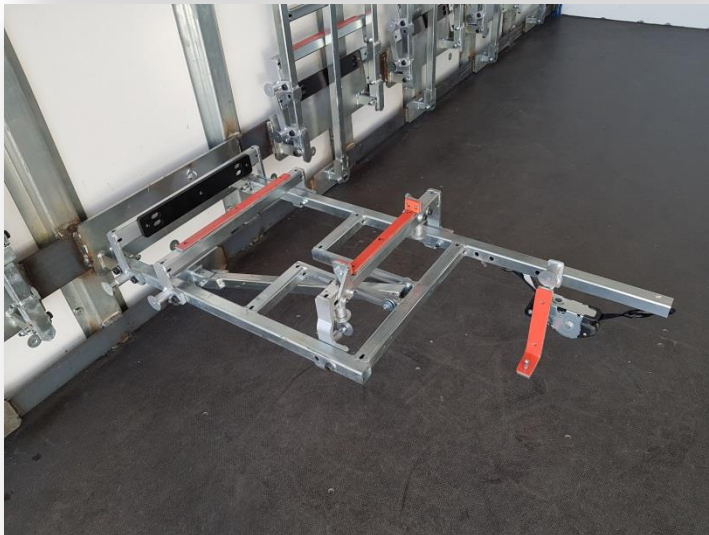



# Chariots motorisés version 2T



- Chariot équipé de roulettes motorisées
- Capacité 2 tonnes
- Table de levage manuelle ou vérin hydraulique sur pompe électrique.
- Couronne d'orientation
- Possibilité de recharger en tractant le chariot



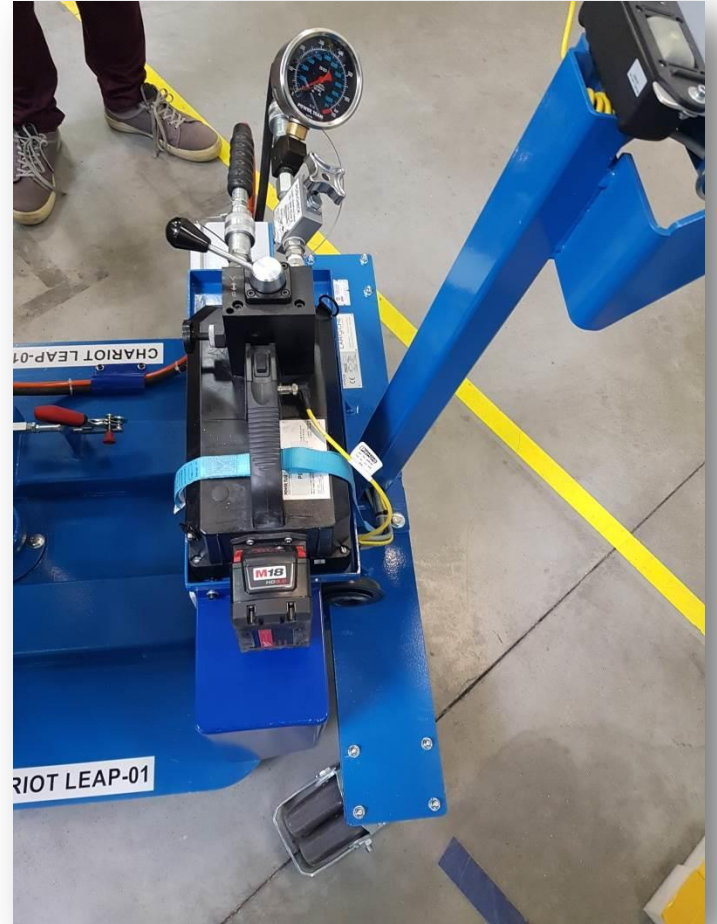
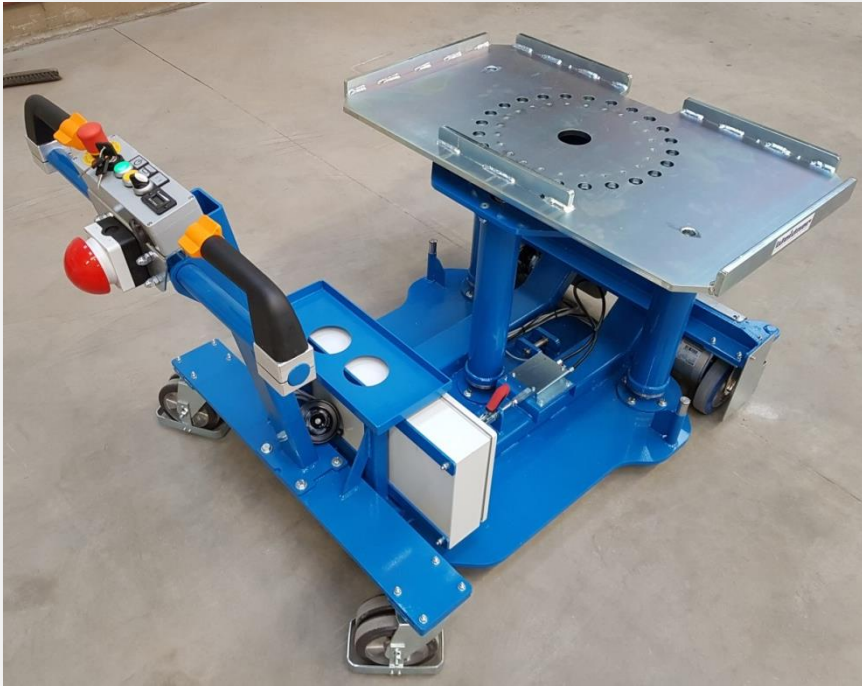

# Chariot motorisé version 1T



- Chariot équipé de roulettes motorisées
- Capacité 1 tonnes
- Alimentation par 2 batteries 5Ah





# Crochets rotatifs modulaires





# Aménagement de remorques



# Aménagement bords de lignes

Rehausseurs, retourneurs et palettiers :

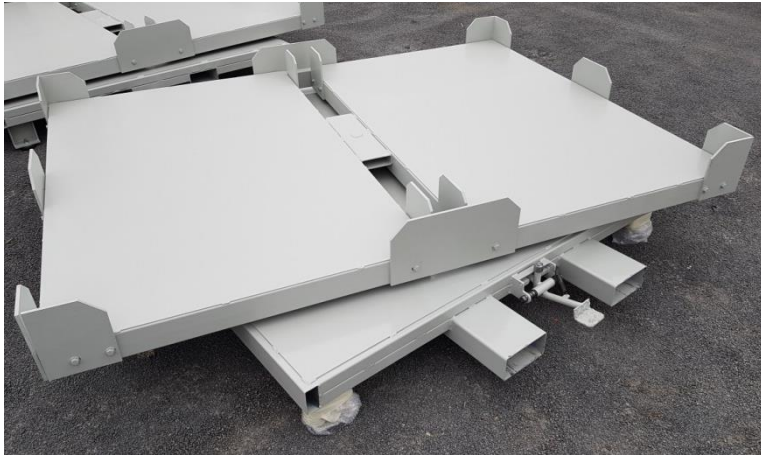

# Dollies



# Shooters



# Meubles bords de lignes

